



DEPARTMENT OF THE AIR FORCE
377TH AIR BASE WING (AFGSC)

14 March 2021

Colonel David S. Miller, USAF
Commander
377th Air Base Wing
2000 Wyoming Blvd SE
Kirtland AFB NM 87117

Mr. Kevin Pierard
Chief, Hazardous Waste Bureau (HWB)
New Mexico Environment Department (NMED)
2905 Rodeo Park Drive East, Building 1
Santa Fe NM 87505-6303

Dear Mr. Pierard

Attached, please find the *Final Ethylene Dibromide In Situ Biodegradation Pilot Test Report, Revision 1, Bulk Fuels Facility, Solid Waste Management Units ST-106 and SS-111, Kirtland Air Force Base, New Mexico*, dated March 2021. The final report was prepared to describe activities and data associated with the pilot test conducted at the Bulk Fuels Facility on Kirtland Air Force Base in accordance with the NMED letter dated 25 February 2019. This revision 1 of the final report addresses the 04 March 2020 *Disapproval Ethylene Dibromide In Situ Biodegradation Pilot Test Report Bulk Fuels Facility Solid Waste Management Units ST-106 and SS-111 Kirtland Air Force Base, New Mexico EPA ID# NM6213820974 HWB-KAFB-19-011* issued by NMED Hazardous Waste Bureau. A response to comment table addressing NMED comments and a redlined version of the report are included as Appendix A to the subject report.

If you have any questions or concerns, please contact Mr. Sheen Kottkamp at commercial (505) 846-7674 or by email sheen.kottkamp.1@us.af.mil.

Sincerely

DAVID S. MILLER, Colonel, USAF
Commander

Attachment:

Final Ethylene Dibromide In Situ Biodegradation Pilot Test Report, Revision 1, Bulk Fuels Facility, Solid Waste Management Units ST-106 and SS-111, Kirtland Air Force Base, New Mexico, dated March 2021; 2 Hard Copies/2 CDs

cc:

NMED Resource Protection Division (Stringer), letter and CD
NMED-HWB (Periard, Address), letter and CD
NMED-GWQB (Hunter), letter and CD
EPA Region 6 (King, Ellinger), letter and CD
ABCWUA (Agnew), electronic only
SAF-IEE (Lynnes), electronic only
AFCEC/CZ (Renaghan, Clark, Kottkamp, Segura), electronic only
USACE-ABQ District Office (Moayyad, Phaneuf, Dreeland, Cordova, Kunkel), electronic only
Public Info Repository, Administrative Record/Information Repository (AR/IR) and File

**KIRTLAND AIR FORCE BASE
ALBUQUERQUE, NEW MEXICO**

**FINAL
ETHYLENE DIBROMIDE *IN SITU* BIODEGRADATION
PILOT TEST REPORT, REVISION 1
BULK FUELS FACILITY
SOLID WASTE MANAGEMENT UNITS ST-106 AND
SS-111
KIRTLAND AIR FORCE BASE, NEW MEXICO**

March 2021



**377 MSG/CEI
2050 Wyoming Boulevard SE
Kirtland Air Force Base, New Mexico 87117-5270**

**KIRTLAND AIR FORCE BASE
ALBUQUERQUE, NEW MEXICO**

**FINAL
ETHYLENE DIBROMIDE *IN SITU* BIODEGRADATION PILOT TEST
REPORT, REVISION 1**

**BULK FUELS FACILITY
SOLID WASTE MANAGEMENT UNITS ST-106 AND SS-111**

March 2021

Prepared for

U.S. Army Corps of Engineers
Omaha District
1616 Capitol Avenue
Omaha, Nebraska 68102

USACE Contract No. W9128F-12-D-0003
Task Order 0025

Prepared by

Aptim Federal Services, LLC
17 Princess Road
Lawrenceville, New Jersey 08648

REPORT DOCUMENTATION PAGE

Form Approved
OMB No. 0704-0188

Public reporting burden for this collection of information is estimated to average 1 hour per response, including the time for reviewing instructions, searching existing data sources, gathering and maintaining the data needed, and completing and reviewing this collection of information. Send comments regarding this burden estimate or any other aspect of this collection of information, including suggestions for reducing this burden to Department of Defense, Washington Headquarters Services, Directorate for Information Operations and Reports (0704-0188), 1215 Jefferson Davis Highway, Suite 1204, Arlington, VA 202-4302. Respondents should be aware that notwithstanding any other provision of law, no person will be subject to any penalty for failing to comply with a collection of information if it does not display a currently valid OMB control number. **PLEASE DO NOT RETURN YOUR FORM TO THE ABOVE ADDRESS.**

1. REPORT DATE (08-11-2019) March 2021		2. REPORT TYPE Final, Revision 1		3. DATES COVERED (From - To) September 2016 – October 2020	
4. TITLE AND SUBTITLE Ethylene Dibromide <i>In Situ</i> Biodegradation Pilot Test Report, Revision 1, Bulk Fuels Facility, Solid Waste Management Units ST-106 and SS-111, Kirtland Air Force Base, Albuquerque, New Mexico				5a. CONTRACT NUMBER W912DY16D0022 Delivery Order W912PP19F0053	
				5b. GRANT NUMBER	
				5c. PROGRAM ELEMENT NUMBER	
6. AUTHOR(S) Aptim Federal Services, LLC				5d. PROJECT NUMBER 500433/501397	
				5e. TASK NUMBER	
				5f. WORK UNIT NUMBER Not Applicable	
7. PERFORMING ORGANIZATION NAME(S) AND ADDRESS(ES) Aptim Federal Services, LLC 17 Princess Road Lawrenceville, New Jersey 08648				8. PERFORMING ORGANIZATION REPORT NUMBER KAFB -019-0001	
9. SPONSORING / MONITORING AGENCY NAME(S) AND ADDRESS(ES) USACE Albuquerque District 4101 Jefferson Plaza NE Albuquerque, New Mexico 87109-3435				10. SPONSOR/MONITOR'S ACRONYM(S)	
				11. SPONSOR/MONITOR'S REPORT NUMBER(S)	
12. DISTRIBUTION / AVAILABILITY STATEMENT					
13. SUPPLEMENTARY NOTES					
14. ABSTRACT This Ethylene Dibromide <i>In Situ</i> Biodegradation Pilot Test Report has been prepared to describe activities and data associated with the ethylene dibromide (EDB) <i>in situ</i> biodegradation pilot test. The pilot test described herein was conducted to investigate anaerobic <i>in situ</i> bioremediation (ISB) of 1,2-dibromoethane (i.e., ethylene dibromide; EDB). ISB, with and without bioaugmentation, is a common remedial approach to treat chlorinated solvents such as trichloroethene and is a promising technology for promoting the degradation of EDB to nontoxic products. The efforts described herein evaluated the extent to which potential treatment amendments for <i>in situ</i> biostimulation enhanced anaerobic EDB biodegradation processes. EDB degradation was evident during the pilot test with a greater than three-log reduction (99.9 percent) to below the United States Environmental Protection Agency maximum contaminant level of 0.05 micrograms per liter at wells KAFB-106MW2-S and KAFB-106064 after biostimulation efforts. EDB degradation was evident through comparison with benzene and toluene concentrations, and the production of EDB degradation products ethene, ethane, and bromide suggested that this degradation occurred by reductive debromination. Higher EDB delta carbon-13 values (observed to be as high as +5‰ or per mil) provided additional isotopic evidence of EDB degradation.					
15. SUBJECT TERMS Bulk Fuels Facility; Pilot Test Report; well installation; well development; surveying; treatment system design, construction, and operation; groundwater sampling; analytical results.					
16. SECURITY CLASSIFICATION OF:			17. LIMITATION OF ABSTRACT ABSTRACT	18. NUMBER OF PAGES 133	19a. NAME OF RESPONSIBLE PERSON Sheen Kottkamp
a. REPORT UNCLASSIFIED	b. ABSTRACT UNCLASSIFIED	c. THIS PAGE UNCLASSIFIED			19b. TELEPHONE NUMBER (include area code) (505)-846-7674

**40 CODE OF FEDERAL REGULATIONS 270.11
DOCUMENT CERTIFICATION**

I certify under penalty of law that this document and all attachments were prepared under my direction or supervision in accordance with a system designed to assure that qualified personnel properly gather and evaluate the information submitted. Based on my inquiry of the person or persons who manage the system, or those persons directly responsible for gathering the information, the information submitted is, to the best of my knowledge and belief, true, accurate, and complete. I am aware that there are significant penalties for submitting false information, including the possibility of fines and imprisonment for knowing violations.



DAVID S. MILLER, Colonel, U.S. Air Force
Commander, 377th Air Base Wing

14 March 2021

Date

This document has been approved for public release.



KIRTLAND AIR FORCE BASE
377th Air Base Wing Public Affairs

3/11/21

Date

PREFACE

This Ethylene Dibromide *In Situ* Biodegradation Pilot Test Report has been prepared by Aptim Federal Services, LLC (APTIM) for Kirtland Air Force Base under U.S. Army Corps of Engineers (USACE), Contract Number W912DY16D0022, Delivery Order W912PP19F0053. It pertains to the Kirtland Air Force Base Bulk Fuels Facility, Solid Waste Management Units ST-106 and SS-111 located in Albuquerque, New Mexico. This report was prepared in accordance with applicable federal, state, and local laws and regulations, including the New Mexico Hazardous Waste Act, New Mexico Statutes Annotated 1978, the New Mexico Water Quality Act, New Mexico Hazardous Waste Management Regulations, Resource Conservation and Recovery Act, and the Water Quality Control Commission Regulations.

This Pilot Test Report presents and describes all activities and data associated with the ethylene dibromide *in situ* biodegradation pilot test.

Kathleen E Romalia

Kathleen Romalia
Aptim Federal Services, LLC
Project Manager

CONTENTS

Section	Page
ACRONYMS AND ABBREVIATIONS	vii
EXECUTIVE SUMMARY	ES-1
1. INTRODUCTION	1-1
1.1 Pilot Test Objectives	1-1
1.2 Site Description	1-2
1.3 Site History	1-2
1.4 Site Conditions	1-3
1.5 Report Organization	1-5
2. PILOT SYSTEM DESIGN AND CONSTRUCTION	2-1
2.1 Permitting	2-1
2.2 Utility Clearance	2-2
2.3 Well Design and Installation	2-3
2.3.1 Groundwater Monitoring Well Installation	2-5
2.3.2 Borehole Deviation and Borehole Abandonment	2-5
2.3.3 Extraction Well Installation	2-6
2.3.4 Injection Well Installation	2-7
2.3.5 Extraction and Injection Well Vaults	2-7
2.4 Well Development	2-8
2.4.1 Groundwater Monitoring Well Development	2-8
2.4.2 Extraction Well Development	2-9
2.4.3 Injection Well Development	2-9
2.4.4 Pump Installation	2-10
2.5 Well Survey	2-12
2.6 Recirculation Pilot System Equipment and Materials	2-12
3. PILOT SYSTEM OPERATION AND MONITORING	3-1
3.1 Pilot System Start-up Testing	3-1
3.2 2017 NAPL Sampling	3-2
3.3 Baseline Sampling	3-3
3.4 Phase 1 – Tracer Testing	3-4
3.5 Phase 2 – Biostimulation	3-7
3.6 Phase 3 – Biostimulation	3-11
3.7 Phase 4 – Extended Monitoring	3-13
3.7.1 Extraction and Injection Well Maintenance	3-14
3.7.2 2020 NAPL Removal Activities	3-15
3.8 Sample Analysis	3-16
3.9 Sample Documentation	3-18
3.10 Quality Control	3-18
3.11 Waste Management	3-19
3.11.1 Soil IDW	3-19

3.11.2	Liquid IDW – Development and Decontamination	3-20
3.11.3	Liquid IDW – Purge Water.....	3-21
3.11.4	NAPL IDW	3-22
4.	PILOT TEST RESULTS	4-1
4.1	Baseline Conditions	4-1
4.2	Amendment Distribution	4-2
4.2.1	Tracer Distribution During Phase 1	4-2
4.2.2	Tracer Distribution During Phase 2, 3, and 4	4-4
4.2.3	Distribution of Fermentable Substrate	4-7
4.3	Microbial Analysis.....	4-9
4.4	Geochemistry	4-11
4.5	Selected Contaminants of Interest	4-15
4.5.1	Benzene and Toluene	4-15
4.5.2	EDB	4-18
5.	CONCLUSIONS	5-1
5.1	Conclusions.....	5-1
6.	REFERENCES	REF-1

APPENDICES

- Appendix A NMED Notice of Disapproval, Response to Comments Table, and Redlined Revised Final Report
- Appendix B Site Photographs
- Appendix C Approved Permits
- Appendix D Well Installation Forms
- Appendix E Borehole Abandonment and Deviation Test Documentation
- Appendix F Final Pilot Test System Design Drawings and Specification Sheets
- F-1. Final Design Drawings
- F-2. Specification Sheets
- Appendix G Safety Data Sheets
- Appendix H Field Sampling Records
- H-1. Groundwater Purge Logs
- H-2. Sample Collection Logs
- Appendix I Data Quality Evaluation Report and Data Packages
- I-1. Data Quality Evaluation Report (June 2017 – January 2019)
- I-2. Data Quality Evaluation Report (March 2020 – October 2020)
- I-3. Data Packages
- Appendix J Waste Disposal Documentation
- J-1. Soil IDW Disposal Letters and Approvals
- J-2. Corrective Action Report
- J-3. Non-Hazardous Waste Manifests
- J-4. Hazardous Waste Manifests
- J-5. Waste Profiles

FIGURES

Figure

- 1 Area Location Map
- 2 Site Location Map
- 3 Concentrations of EDB in Anaerobic Microcosms Prepared with Aquifer Samples Collected from the BFF Source Area
- 4 Pilot Test Well Layout
- 5 Recirculation and Amendment System Piping and Instrument Diagram
- 6 Process Flow Diagram
- 7 Recirculation Groundwater Elevations
- 8 EDB Concentrations for Baseline and Phase 4 Sampling Events
- 9 Fluoroscein Concentrations – Shallow Wells
- 10 Fluoroscein Concentrations – Intermediate Wells
- 11 $\delta^2\text{H}$ Concentrations – Shallow Wells
- 12 $\delta^2\text{H}$ Concentrations – Intermediate Wells
- 13 Iodide Concentrations – Shallow Wells
- 14 Iodide Concentrations – Intermediate Wells
- 15 Lactic Acid Concentrations – All Wells (Except 106IN1)
- 16 Acetic Acid Concentrations – All Wells (Except 106IN1)
- 17 Propionic Acid Concentrations – All Wells (Except 106IN1)
- 18 EBAC Concentrations – All Wells
- 19 APS Concentrations – All Wells
- 20 MGN Concentrations – All Wells
- 21 DHBt Concentrations – All Wells
- 22 DCM Concentrations – All Wells
- 23 DHG Concentrations – All Wells

FIGURES (concluded)**Figure**

- 24 DSB Concentrations – All Wells
- 25 Dissolved Oxygen Concentrations – All Wells
- 26 Sulfate Concentrations – All Wells
- 27 Iron Concentrations – All Wells
- 28 Methane Concentrations – All Wells
- 29 Benzene Concentrations – All Wells
- 30 Toluene Concentrations – All Wells
- 31 EDB Concentrations – All Wells
- 32 VOC Reduction – All Wells
- 33 Ethene/Ethane EDB Equivalent – Shallow Wells
- 34 Ethene/Ethane EDB Equivalent – Intermediate Wells
- 35 Bromide vs. Chloride – All Wells
- 36 Br/Cl Ratio – Shallow Wells
- 37 Br/Cl Ratio – Intermediate Wells
- 38 EDB $\delta^{13}\text{C}$ - Shallow Wells

TABLES

Table

- 1 Well Completion and Survey Summary
- 2 Timeline of System Operation
- 3 Summary of Field Water Quality Measurements
- 4 Groundwater Sampling Frequency, Parameters, and Methods
- 5 Manual Water Level Measurements
- 6 Amendment Batching Summary
- 7 Analytical Data Table for KAFB-106063
- 8 Analytical Data Table for KAFB-106064
- 9 Analytical Data Table for KAFB-106EX1
- 10 Analytical Data Table for KAFB-106EX2
- 11 Analytical Data Table for KAFB-106IN1
- 12 Analytical Data Table for KAFB-106MW1-I
- 13 Analytical Data Table for KAFB-106MW1-S
- 14 Analytical Data Table for KAFB-106MW2-I
- 15 Analytical Data Table for KAFB-106MW2-S
- 16 Measures of Tracer Distribution during Phase 1
- 17 Contaminant Reduction during Test Phases

ACRONYMS AND ABBREVIATIONS

%	percent
µg/L	microgram per liter
µm	micron
‰	per mil
¹³ C	carbon-13, stable isotope of carbon
² H ₂ O	deuterium oxide, deuterated water
AFB	Air Force Base
APS	sulfate reducing bacteria
APTIM	Aptim Federal Services, LLC
ARCH	Air Rotary Casing Hammer
AvGas	aviation gasoline
BFF	Bulk Fuels Facility
bgs	below ground surface
Calcon	Systems Inc.
cells/mL	cells per milliliter
CSIA	compound-specific isotope analysis
DAP	diammonium phosphate
DCM	<i>Dehalobacter</i> DCM
DHBt	<i>Dehalobacter</i> spp.
DHC	<i>Dehalococcoides</i>
DHG	<i>Dehalogenimonas</i> spp.
DI	deionized
DO	dissolved oxygen
DSB	<i>Desulfitobacterium</i> spp.
DTIC	Defense Technical Information Center
EBAC	total eubacteria
EDB	ethylene dibromide/1,2-dibromoethane
EPA	United States Environmental Protection Agency
ESTCP	Environmental Security Technology Certification Program
FCV	flow control valve
Fe	iron
FFOR	Former Fuel Offloading Rack
gpm	gallon per minute
IDW	investigation-derived waste
ISB	<i>in situ</i> bioremediation
JP-4	jet propellant fuel grade 4
JP-8	jet propellant fuel grade 8
KAFB	Kirtland Air Force Base

KI	potassium iodide
MCL	maximum contaminant level
mg/kg	milligram per kilogram
mg/L	milligram per liter
MGN	methanogens
NAPL	non-aqueous phase liquid
NMED	New Mexico Environment Department
No.	number
OOM	order of magnitude
ORP	oxidation-reduction potential
OSE	Office of the State Engineer
P&ID	pipng and instrumentation diagram
Pace	Pace Analytical®
PID	photo ionization detector
PM	Project Manager
PVC	polyvinylchloride
QED	QED Environmental Systems
RCRA	Resource Conservation and Recovery Act
Report	Ethylene Dibromide <i>In Situ</i> Biodegradation Pilot Test Report
SCADA	Supervisory Control and Data Acquisition
SDC-9	debrominating culture
SWMU	Solid Waste Management Unit
USACE	U.S. Army Corps of Engineers
USGS	U.S. Geological Survey
VOC	volatile organic compound
Work Plan	Ethylene Dibromide <i>In Situ</i> Biodegradation Pilot Test Work Plan
$\delta^{13}\text{C}$	delta carbon-13 (measure of carbon isotope composition)
$\delta^2\text{H}$	delta deuterium (measure of hydrogen isotope composition)

EXECUTIVE SUMMARY

This Ethylene Dibromide *In Situ* Biodegradation Pilot Test Report (Report) was prepared to describe activities and data associated with the pilot test conducted at the Bulk Fuels Facility (BFF) on Kirtland Air Force Base (AFB) in accordance with the New Mexico Environment Department (NMED) letter dated February 25, 2019 (NMED, 2019). The BFF site was the location of an accidental leak of aviation gasoline and jet propellant fuel grades 4 and 8 that was discovered in 1999. Based on historical Air Force fuel usage, aviation gasoline containing ethylene dibromide/1,2-dibromoethane (EDB) as a lead scavenger would have been in use from approximately the 1940s to 1975 (Kirtland AFB, 2011a). The investigation and remediation of the BFF leak (Solid Waste Management Units ST-106 and SS-111) is being implemented pursuant to the Resource Conservation and Recovery Act (RCRA) corrective action provisions in Part 6 of the Kirtland AFB Hazardous Waste Treatment Facility Operating Permit (Permit Number NM9570024423, referred to as the RCRA Permit) (NMED, 2010). This pilot test was performed pursuant to the NMED-approved Ethylene Dibromide *In Situ* Biodegradation Pilot Test Work Plan (Work Plan; Kirtland AFB, 2016a) and Phase 3 Notification Letter (Kirtland AFB, 2018a).

This stand-alone Executive Summary briefly summarizes the pilot test objectives, construction activities, results, and conclusions of this Report. Sections 1 through 3 of the main Report describe the activities performed during the implementation of the pilot test. Section 4 describes pilot test analytical results and performance. Section 5 provides conclusions.

The pilot test was conducted to investigate anaerobic *in situ* bioremediation of EDB in groundwater associated with the BFF site. *In situ* bioremediation, with and without bioaugmentation, is a common remedial approach to treat chlorinated solvents such as trichloroethene and is a promising technology for promoting the degradation of EDB to nontoxic products. The pilot test was primarily designed to evaluate

the extent to which potential treatment amendments for *in situ* biostimulation and bioaugmentation enhance anaerobic EDB biodegradation processes.

Site preparation activities, mobilization, and installation of the Pilot Test System were performed from September 2016 through May 2017. Construction of the Pilot Test System consisted of the installation and development of seven wells; construction of underground piping, conduit, and direct buried electrical lines, and the installation of the system control building with required electrical service and components.

The pilot test utilized one injection, two extraction, and six monitoring wells, including existing monitoring wells KAFB-106064 and KAFB-106063 (nine wells total) (Figure ES-1). Well KAFB-106IN1 was installed and used as an injection well for recirculated groundwater and amendment injection; wells KAFB-106EX1 and KAFB-106EX2 were installed and used as groundwater extraction wells; and existing wells KAFB-106064 and KAFB-106063, and new nested wells KAFB-106MW1-S, KAFB-106MW1-I, KAFB-106MW2-S, and KAFB-106MW2-I were used as monitoring wells. The new shallow groundwater monitoring wells (KAFB-106MW1-S and KAFB-106MW2-S) are screened with 15 feet above the static water table and 20 feet extending below the water table, as measured at the time of well installation. The new intermediate wells (KAFB-106MW1-I and KAFB-106MW2-I) were installed within the intermediate groundwater zone are screened 35 feet below the water table.

The system for amending and recirculating groundwater was designed by Aptim Federal Services, LLC, together with subcontractors, and was fabricated by Calcon Systems Inc. The system is contained within a 20-foot long Conex box. The Conex box has a partition wall, separating the enclosure into two spaces. The smaller of the two spaces is the system control room that houses the supervisory control and data acquisition system with integrated computer, electrical control panel, Baski flow control valve controls and associated nitrogen cylinder, and a combination air conditioner/heater. The larger space houses

system process components. Shakedown testing was performed on May 16 through 17, 2017 prior to full system start-up.

The pilot test was implemented in four phases, each briefly described below:

- Phase 1—Evaluation of baseline conditions and the distribution of recirculated water using tracer amendments.
- Phase 2—Evaluation of biostimulation in the subsurface after distribution of treatment amendments in recirculated groundwater.
- Phase 3— Additional evaluation of biostimulation in the subsurface after distribution of treatment amendments in recirculated groundwater.
- Phase 4—Extended monitoring with no addition of amendments or recirculation of groundwater.

Groundwater samples were collected intermittently at extraction, injection, and the six groundwater monitoring wells during the active and the passive portions of the phases, except for Phase 4, which did not include an active recirculation portion. Samples were sent to numerous analytical laboratories for analysis.

Per the Work Plan (Kirtland AFB, 2016a), Phase 3 was to consist of both biostimulation and bioaugmentation with a known debrominating culture (SDC-9); however, after review of field results from both Phase 1 and Phase 2, it was determined that bioaugmentation was not yet warranted. Due to the success of biostimulation during Phase 2, Phase 3 was modified to further evaluate biostimulation and a Phase 3 Notification Letter was submitted to the NMED on July 26, 2018. The modified Phase 3 was approved by the NMED in a letter dated August 7, 2018 (NMED, 2018), which also stated that “bioaugmentation shall remain as an approved, but deferred component of the pilot test.”

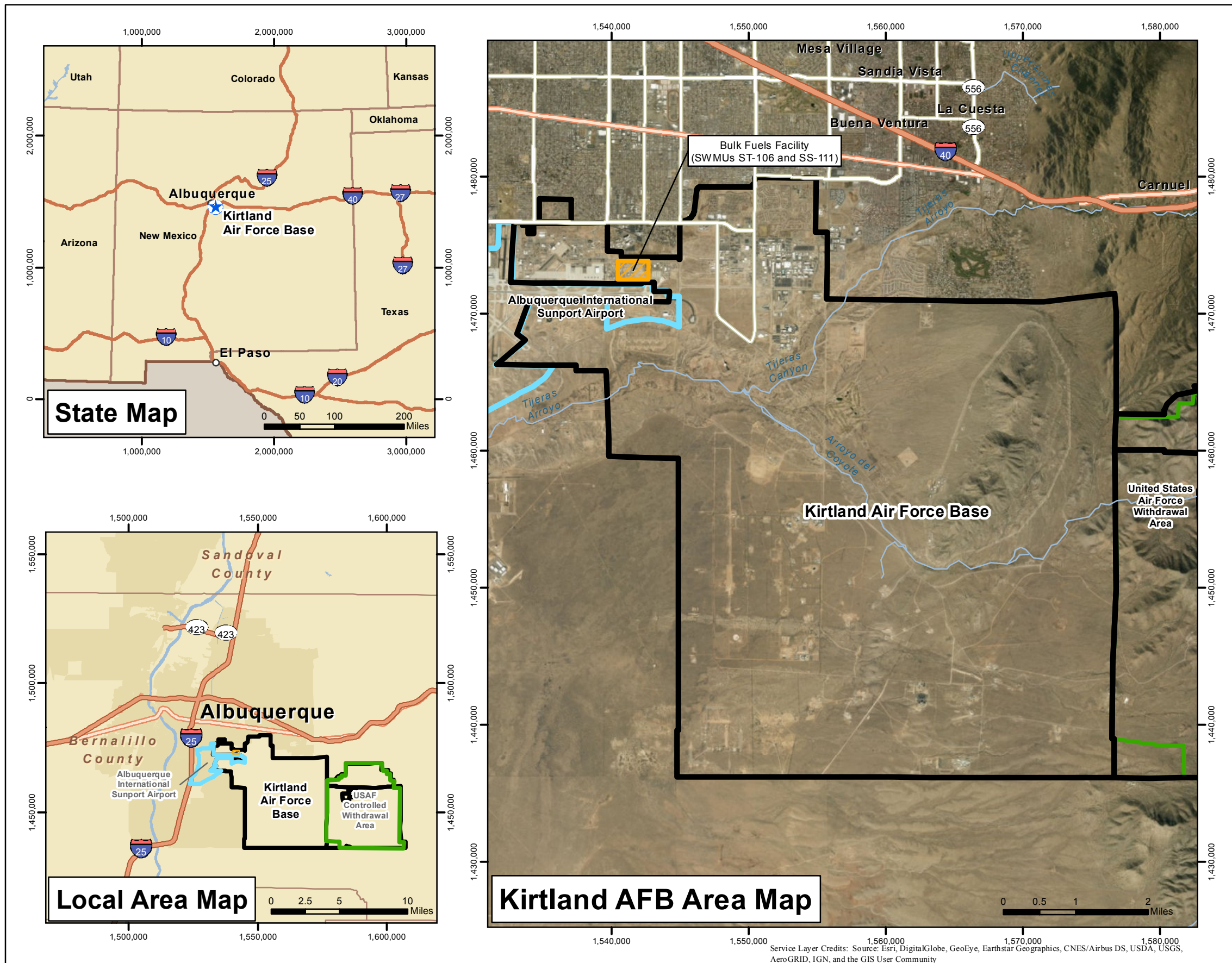

Legend

- Installation Location
- Kirtland Air Force Base
- Installation Boundary
- Bulk Fuels Facility (SWMUs ST-106 and SS-111)
- Albuquerque International Sunport Airport
- United States Air Force Withdrawal Area
- Major Highways
- Highways
- Major Roads
- Rivers
- Urban Areas
- Counties
- States

SWMUs = Solid Waste Management Unit
 AFB = Air Force Base
 USAF = United States Air Force

N Revision Date: 02/20/19

Projection : NAD83 State Plane New Mexico Central FIPS3002 Feet

ETHYLENE DIBROMIDE IN SITU BIODEGRADATION
 PILOT TEST REPORT
 KIRTLAND AIR FORCE BASE, NEW MEXICO

FIGURE ES-1

AREA LOCATION MAP

The results for the four phases of the pilot test are summarized below:

- EDB concentrations at shallow monitoring wells during the baseline evaluation ranged from 20.1 micrograms per liter ($\mu\text{g/L}$) at KAFB-106IN1 to 432 $\mu\text{g/L}$ at KAFB-106MW1-S, and among the intermediate wells EDB was only detected at KAFB-106MW2-I with a concentration of 0.122 $\mu\text{g/L}$. EDB concentrations are shown on Figure ES-2. Baseline microbial results indicated that the subsurface was biologically active prior to pilot test activities.
- EDB concentrations at shallow monitoring wells during the Phase 1 (tracer test) recirculation period ranged from 50.4 $\mu\text{g/L}$ (KAFB-106EX1) to 137 $\mu\text{g/L}$ (KAFB-106EX2) (Figure ES-2). EDB concentrations at the shallow monitoring wells decreased during the following Phase 1 passive period, with EDB reductions of approximately 75 percent (%) observed at wells KAFB-106064 (20.1 $\mu\text{g/L}$), KAFB-106EX1 (12.9 $\mu\text{g/L}$), and KAFB-106MW2-S (15 $\mu\text{g/L}$) after the one-month passive period (Figure ES-2). Biostimulation amendments were not added during Phase 1. The results from tracer test during Phase 1 indicated that the targeted treatment zone encompassing the shallow groundwater monitoring wells were hydraulically connected with the injection well. Distribution of tracers to groundwater sampled by monitoring wells nearest to the injection well (KAFB-106MW2-S and KAFB-106064) occurred within 5 days of operation, suggesting a high likelihood of successfully distributing biostimulation amendments that help facilitate reductive debromination of EDB.
- During the Phase 2 (biostimulation) recirculation period, the range of EDB concentrations observed at shallow monitoring wells was less variable, ranging from 66.4 $\mu\text{g/L}$ at KAFB-106MW1-S to a maximum of 90.9 $\mu\text{g/L}$ at KAFB-106EX2 (Figure ES-2). EDB was detected at the intermediate monitoring wells during the Phase 2 recirculation period. Except for KAFB-106EX2, EDB concentrations decreased during the Phase 2 passive period by

approximately 90 percent (%) or more with concentrations down to below detection limits (KAFB-106IN1, KAFB-106MW2-S).

- During the Phase 3 (biostimulation) recirculation period, the range of EDB concentrations observed at shallow monitoring wells was more variable than during the Phase 2 recirculation period, ranging from approximately 3 µg/L at KAFB-106064 to a maximum of 97 µg/L KAFB-106EX2 (Figure ES-2). Except for KAFB-106EX2, EDB concentrations during the subsequent passive period decreased by 95% or more relative to maximums observed during the preceding recirculation period, with concentrations ranging down to 0.019 µg/L (KAFB-106MW2-S).
- There was little evidence of significant increases in EDB concentrations (i.e., rebound) during Phase 4 sampling events, which concluded in October 2020. Based on iodide tracer concentrations, groundwater transport in the vicinity of the pilot test appeared limited during this period. During Phase 4, EDB concentrations ranged from 0.016 µg/L at KAFB-106MW2-S to 62 µg/L at KAFB-106EX2. EDB decreased at KAFB-106EX2 relative to the concentration measured during the first Phase 4 sampling event in January 2019 (62 µg/L) with a final EDB concentration of 0.36 µg/L measured during the October 2020 sampling event.

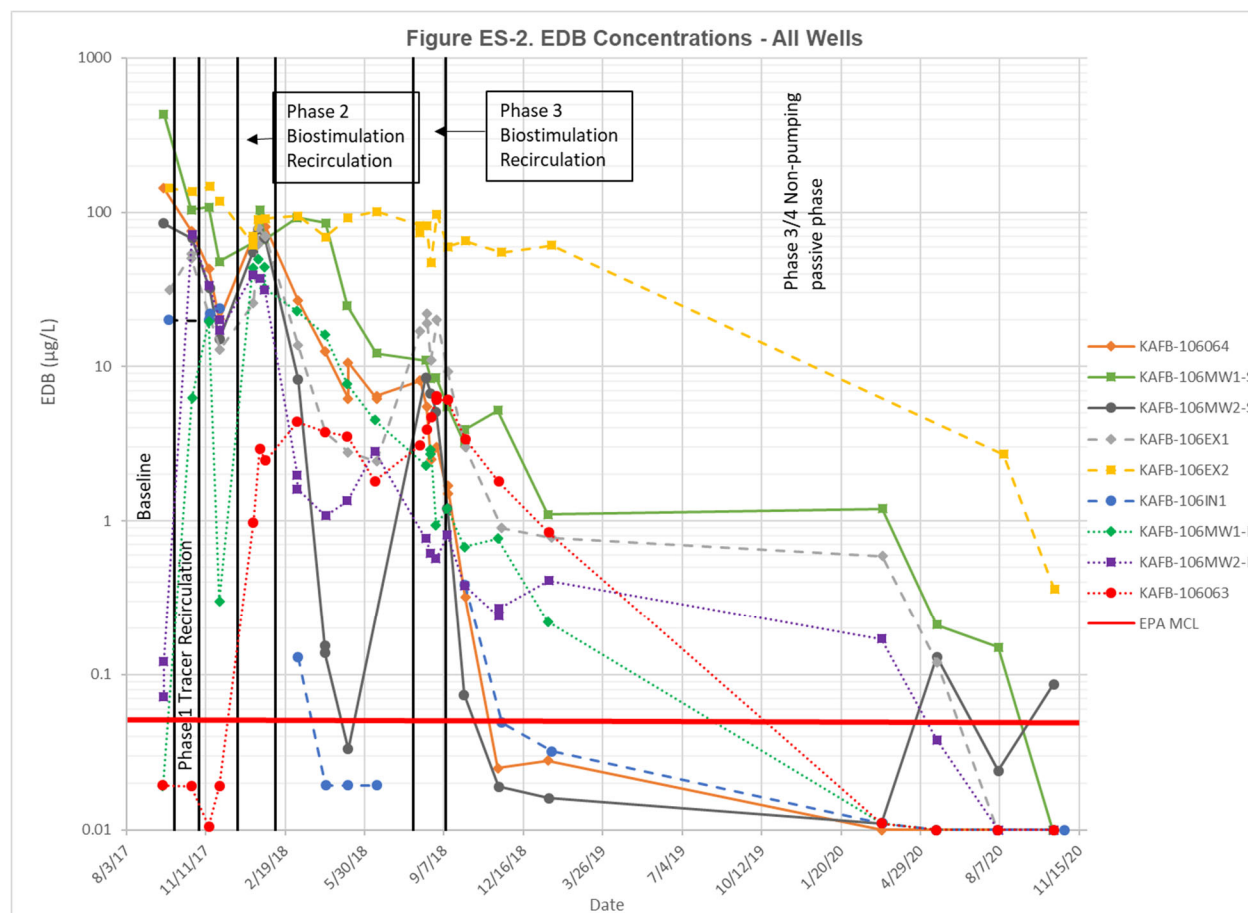

EDB degradation was evident during the pilot test with a greater than two-log reduction (>99%) at all wells examined. In October 2020, EDB concentrations at all but two wells were below the United States Environmental Protection Agency (EPA) maximum contaminant level (MCL) of 0.05 µg/L (EPA, 2009). The two wells exceeding the EPA MCL for EDB in October 2020 were KAFB-106MW2-S (0.087 µg/L) and KAFB-106EX2 (0.36 µg/L). EDB degradation was evident through comparison with benzene and toluene concentrations, and the production of EDB degradation products ethene, ethane, and bromide suggested that this degradation occurred by reductive debromination. Dissolved oxygen, sulfate, iron, and methane concentrations observed throughout much of the pilot test indicated that bulk anaerobic conditions generally considered to be necessary for reductive debromination were present. Higher EDB delta carbon-13 values (observed to be as high as +5 per mil) provided additional isotopic evidence of EDB degradation.

1. INTRODUCTION

This *Ethylene Dibromide In Situ Biodegradation Pilot Test Report* (Report) has been prepared by Aptim Federal Services, LLC (APTIM) for Kirtland Air Force Base (AFB) under the U.S. Army Corps of Engineers (USACE) Contract Number (No.) W912DY16D0022, Delivery Order W912PP19F0053. The test described in this Report was implemented at the Kirtland AFB Bulk Fuels Facility (BFF) site, Solid Waste Management Units (SWMUs) ST-106 and SS-111. The investigation and remediation of the BFF leak (SWMUs ST-106 and SS-111) is being implemented pursuant to the Resource Conservation and Recovery Act (RCRA) corrective action provisions in Part 6 of the Kirtland AFB Hazardous Waste Treatment Facility Operating Permit (Permit No. NM9570024423, referred to as the RCRA Permit) (New Mexico Environment Department [NMED], 2010). This pilot test was performed pursuant to the *Ethylene Dibromide In Situ Biodegradation Pilot Test Work Plan* (Work Plan; Kirtland AFB, 2016a) and the Phase 3 Notification Letter (Kirtland AFB, 2018a).

This pilot test was conducted to investigate anaerobic *in situ* bioremediation (ISB) of 1,2-dibromoethane (i.e., ethylene dibromide [EDB]). ISB, with and without bioaugmentation, is a common remedial approach to treat chlorinated solvents such as trichloroethene and is a promising technology for promoting the degradation of EDB to nontoxic products. This pilot test was designed to evaluate the use of *in situ* biostimulation to enhance anaerobic EDB biodegradation processes.

1.1 Pilot Test Objectives

The primary objective of this pilot test was to evaluate the extent to which potential treatment amendments for ISB enhance anaerobic EDB biodegradation processes. Evaluation of the test was completed through comprehensive groundwater sampling that assessed both direct and indirect indicators of EDB biodegradation.

1.2 Site Description

Kirtland AFB is located in Bernalillo County, in central New Mexico, southeast of and adjacent to the City of Albuquerque and the Albuquerque International Sunport (Figure 1). The approximate area of the base is 52,287 acres, and it is bordered by Albuquerque to the north and west, the Isleta Pueblo Reservation to the south, and the Cibola National Forest to the east. The BFF site is located in the northwestern part of Kirtland AFB, and is comprised of two SWMUs, designated as ST-106 and SS-111. The pilot test was performed near the EDB contaminant source in an undeveloped area just south of Randolph Road, at the location identified on Figure 2.

The pilot test area included groundwater injection, extraction, and monitoring wells installed near the existing monitoring well cluster that includes Kirtland AFB (KAFB)-106062, KAFB-106063, and KAFB-106064, approximately 300 feet to the east of Building 1024 (Figure 2). The water table at the test location occurs at approximately 480 feet below ground surface (bgs), and the pilot test groundwater wells are screened in the shallow and intermediate zones of the aquifer within the Santa Fe Group. Well screens of the shallow monitoring wells were placed to target the highest EDB concentrations (i.e., approximately the top 20 feet of the aquifer), located in a zone of inter-bedded sands and gravels with occasional finer layers, and groundwater extraction and injection primarily facilitated flow in the soil materials of greatest hydraulic conductivity.

1.3 Site History

The BFF site was the location of a historical, accidental release of aviation gasoline (AvGas) and jet propellant fuel grades 4 (JP-4) and 8 (JP-8). Historical aerial photography revealed that the area was used for fuel storage and processing as early as 1951 (CH2M HILL, 2001). From 1953 to late 1975, the primary fuel stored and used at the BFF was AvGas. The use of AvGas and JP-4 at Kirtland AFB was phased out in 1975 and 1993, respectively (Kirtland AFB, 2011a). JP-8 was handled through the Former Fuel Offloading Rack (FFOR) until the leak was discovered in 1999.

Based on historical Air Force fuel usage, AvGas containing EDB as a lead scavenger would have been in use from approximately the 1940s to 1975. EDB is a suspected human carcinogen that was historically added to leaded fuels to prevent the build-up of lead oxide deposits in engines, including aircraft engines.

The fuels are thought to have leaked undetected over approximately 3 to 4 decades at the FFOR through leak points during fuel transfer. The released fuel migrated through the vadose zone to eventually reach the water table. The migration followed a disjointed, meandering path caused by subsurface heterogeneity, where frequent changes in the alluvial lithology and confining layers created preferential flow pathways. This resulted in non-uniform residual contamination of the vadose zone and measurable non-aqueous phase liquid (NAPL) on the surface of the underlying unconfined aquifer. The presence of NAPL fuel hydrocarbons on the water table indicated that substantial releases had occurred.

1.4 Site Conditions

The historical water table in the vicinity of Kirtland AFB was estimated to be approximately 350 feet bgs before extensive groundwater pumping from the regional aquifer occurred. Throughout the history of the BFF site, the water table has fallen due to groundwater pumping to supply drinking water to the residents of Albuquerque. The deepest depth to water, representing the lowest historical groundwater elevation, measured at groundwater wells in the BFF source area ranged from approximately 500 to 502 feet bgs in 2009. In recent years, the water table has been rising due to water-conservation efforts by the Albuquerque community and reduction of pumping of production wells by Albuquerque Bernalillo County Water Utility Authority. As a result, the current vadose zone at the BFF site is approximately 455 to 480 feet thick.

The background gradient at the pilot test location is small and pumping of wells and reinjection during pilot test operations induced gradients exceeding that of the background. Based on data reviewed for the pilot test design, the groundwater gradient in the pilot test area was less than 0.002 foot/foot (First Quarter

2016), and the direction of groundwater flow had shifted from north-northeast to a more east-southeast direction, likely due to continuing water-conservation practices and seasonal fluctuations, as discussed in the Second Quarter 2018 Quarterly Monitoring Report (Kirtland AFB, 2018b).

Prior to the pilot test during quarterly sampling in 2014 and 2015, groundwater samples were collected from 13 monitoring wells to analyze the *in situ* microbial community at Kirtland AFB using Microbial Insight's QuantArray-Chlor protocol. The method of collection and analysis has been discussed in previous quarterly reports, which can be found on the Air Force Administrative Records site (<http://afcec.publicadmin-record.us.af.mil/Search.aspx>). Results indicated that microorganisms likely to dehalogenate EDB, or its chlorinated analog 1,2-dichloroethane, are present in the subsurface. EDB biodegradation activity, however, was not readily stimulated during *ex situ* treatability tests, but bioaugmentation with a known debrominating culture (SDC-9) significantly enhanced EDB degradation rates during the same tests (Figure 3). The inability to stimulate biodegradation activity during treatability tests may have resulted from the lack of viable debrominating organisms in the collected samples or other challenges simulating subsurface conditions in the lab. The success with a bioaugmentation culture, however, demonstrated that viable debrominating organisms could degrade EDB in the presence of site soils and groundwater. These results indicated that ISB showed promise for enhancing EDB degradation at Kirtland AFB, either through stimulation of the indigenous dehalogenating organisms that were observed to be present *in situ*, or through bioaugmentation with an exogenous debrominating culture (e.g., SDC-9). The pilot test performed here was designed to test both biostimulation and bioaugmentation options, as appropriate. Biostimulation was successful at pilot test scale in the field and bioaugmentation with an exogenous culture was not performed.

1.5 Report Organization

This Report contains a detailed summary of the pilot test implementation, including design considerations, field activities, and a comprehensive documentation of results. The remainder of this Report contains the following sections:

- Section 2 – Pilot System Design and Construction
- Section 3 – Pilot System Operation and Monitoring
- Section 4 – Pilot Test Results
- Section 5 – Conclusions

Figures, tables, and appendices are available following the body of this Report.

2. PILOT SYSTEM DESIGN AND CONSTRUCTION

Site preparation activities, mobilization, and installation of the Pilot Test System were performed from September 2016 through May 2017. Construction of the Pilot Test System consisted of well installation and development; installation of underground piping, conduit, and direct buried electrical lines; and installation of the system control building with required electrical service and components. Appendix B includes 20 representative photographs of various site activities.

2.1 Permitting

Prior to initiating construction activities, the following permits were obtained:

- Kirtland AFB Dig Permit (utility clearance)
- Kirtland AFB Civil Engineer Work Permit
- Office of the State Engineer (OSE) Drill and Install Permit
- OSE Change of Water Rights
- Albuquerque Environmental Health Department Fugitive Dust Permit

One dig permit (Air Force Form 103) was submitted to Kirtland AFB on July 20, 2016 for well installation and trenching for utilities associated with the system. The dig permit was approved on August 15, 2016, and a permit number was issued (1607-014).

Surface disturbances at the pilot test location totaled an area greater than $\frac{3}{4}$ acre and required submittal of a Fugitive Dust Permit Application, which was submitted to the Albuquerque Environmental Health Department on May 12, 2014, prior to initiation of excavation activities, in accordance with 20.11.20

New Mexico Administrative Code. The permit application was approved, and the Fugitive Dust Permit (6621-C) was issued on May 14, 2014.

Two separate permits to “Drill a Well with No Consumptive Use of Water” were submitted to the OSE for monitoring wells, and extraction and injection wells, respectively. Permits were issued for the monitoring wells on November 17, 2016 and for the extraction and injection wells on August 15, 2016. An “Application for Permit to Change an Existing Water Right” was also submitted to the OSE for the extraction and injection wells. The intention of the change of water rights permit was not to increase the allowable groundwater diversion described in RG-1579 through RG-1589, but rather to change the purpose of use to pollution control and recovery, and by adding places of use not currently described in the Kirtland AFB water rights (RG-1579 through RG-1589) for the extraction and injection wells. The change of water rights application was approved by the OSE on December 7, 2016.

Additionally, a Notice of Intent was submitted to the NMED Ground Water Quality Bureau on October 26, 2016 to determine whether a Discharge Permit was required, in accordance with the requirements found in 20.6.2.1201.A New Mexico Administrative Code. NMED Ground Water Quality Bureau determined that a Discharge Permit was not required for pilot test activities in a letter dated December 16, 2016. Appendix C includes all relevant permits.

2.2 Utility Clearance

Prior to the initiation of construction activities, a utility clearance was undertaken at the pilot test site by High Mesa Consulting Group (under subcontract to APTIM) in September 2016. Kirtland AFB utility representatives also performed a utility locate in order to process the submitted dig permits.

2.3 Well Design and Installation

The pilot test utilized one injection, two extraction, and six monitoring wells, including existing monitoring wells KAFB-106064 and KAFB-106063 (nine wells total). Well KAFB-106IN1 was installed and used as an injection well for recirculated groundwater, tracer, and amendment injection; wells KAFB-106EX1 and KAFB-106EX2 were installed and used as groundwater extraction wells; and existing wells KAFB-106064 and KAFB-106063, and new nested wells KAFB-106MW1-S, KAFB-106MW1-I, KAFB-106MW2-S, and KAFB-106MW2-I were used as groundwater monitoring wells. The pilot test wells, which included KAFB-106063, KAFB-106064, and the seven newly installed wells, are shown on Figure 2. A cross-sectional view illustrating the depths of the pilot test wells is shown on Figure 4.

The pilot test wells were sited to accommodate existing well infrastructure, site utilities, and to facilitate use of existing wells for monitoring. The two extraction wells were located 75 to 92 feet from the single injection well, as shown in Figure 2. As detailed later in this Report, the extraction wells were used to periodically recirculate groundwater during individual phases of the pilot test. The periods of active groundwater recirculation were designed to facilitate the distribution of amendments at the test location. Pumping was halted after sufficient amendment distribution and ISB treatment performance was monitored.

Existing monitoring wells KAFB-106063 (screened from 505 to 520 feet bgs, with top of screen approximately 25 feet below the water table) and KAFB-106064 (screened from 485 to 505 feet bgs, with top of screen approximately 5 feet below the water table) were used for groundwater monitoring during the pilot test, along with the other newly installed wells. The design and locations of the new wells were selected to evaluate EDB biodegradation and were located near the injection well to facilitate evaluating the impacts of biostimulation amendments. The four new monitoring wells were installed within two boreholes utilizing a nested configuration with two wells in each borehole in accordance with the Work

Plan (Kirtland AFB, 2016a). Each borehole contained a shallow well with approximately 15 feet of screen in the vadose zone and 20 feet of screen in the aquifer, along with a deeper well (intermediate) with the top of a 10-foot screen set approximately 35 feet below the water table. Well screen intervals were isolated within the borehole using bentonite seals. Well construction diagrams are presented in Appendix D and general construction information for each well is summarized in Table 1.

The two pairs of nested groundwater monitoring wells, two extraction wells, and one injection well were installed by Cascade Drilling (formerly National Exploration Wells & Pumps) using an Air Rotary Casing Hammer (ARCH) drill rig from January through March 2017.

During borehole advancement, soil cuttings were logged every 5 feet by the site geologist in accordance with the Unified Soil Classification System and American Standard Test Method International D1586-84. Soil drill cuttings from just above and in the saturated zone were screened for presence of NAPL and volatile organic compounds (VOCs) using a photo ionization detector (PID) to collect headspace measurements. Drill cuttings were also visually inspected for evidence of staining. PID readings were recorded on the soil boring logs (Appendix D). Staining was not observed during drilling activities; however, elevated PID readings and fuel-like odors were recorded from depths ranging from 473 feet bgs to 515 feet bgs at the wells.

Soil boring logs and well construction diagrams for monitoring, extraction, and injection wells installed during the pilot test are located in Appendix D. Soil borings were reviewed by a professional geologist and submitted to the OSE, in accordance with well permit requirements. Table 1 presents the completion details for the wells, including surveyed elevations and coordinates, and screen depths. All newly installed well locations are depicted on Figure 2.

2.3.1 Groundwater Monitoring Well Installation

Drilling of groundwater monitoring wells began on January 8, 2017, and was completed on February 16, 2017, using Cascade's ARCH drill rig. The four monitoring wells were installed within two boreholes, utilizing a nested well design in accordance with the Work Plan (Kirtland AFB, 2016a). Well construction diagrams are presented in Appendix D and general construction information for each well is summarized in Table 1.

The two shallow monitoring wells (KAFB-106MW1-S and KAFB-106MW2-S) were constructed with 4-inch diameter, Schedule 80, polyvinyl chloride (PVC) riser pipe; and the two intermediate wells (KAFB-106MW1-I and KAFB-106MW2-I) were constructed with 3-inch diameter, Schedule 80, PVC riser pipe. The shallow and intermediate monitoring wells are nested within a telescoping borehole (13-3/8-inch upper and 11-3/4-inch lower diameter) to a depth of approximately 535 feet bgs. The shallow wells were fitted with 35-foot screens, set with 15 feet of screen in the vadose zone and 20 feet in the aquifer. The placement of the shallow monitoring well screens was intended to account for potential water table rise and allow for future monitoring and characterization activities after the completion of this pilot test in the event it is necessary to support the Corrective Measures Evaluation. The intermediate wells are fitted with 10-foot screens, with top of screen installed approximately 35 feet below the water table. Monitoring wells were equipped with a Schedule 80 PVC flush-threaded end cap installed below the screened interval. Additional well construction details are summarized in Table 1 and Appendix D.

2.3.2 Borehole Deviation and Borehole Abandonment

Upon achievement of total depth at the intended borehole location for KAFB-106MW2 (see Figure 6 of the Work Plan), borehole deviation was evaluated using several tools, including a Reflex EZ-Trac 6122 digital field instrument, a mechanical drift detector (Eastman Whipstock Eastco), and a gyroscopic deviation tool. The deviation was measured and evaluated while the drive casing was in the borehole prior to any well installation activities. The bottom of the borehole was measured to be deviated 26.35 feet, on

an azimuth of 113.5 degrees from the north, using the gyroscopic deviation tool. The results from this gyroscopic deviation survey are included in Appendix E. The deviation was likely caused by the casing entry angle, coupled with a change in lithology at 225 feet bgs. Because this borehole was determined to have too large of a vertical deviation, no well infrastructure was installed, and it was abandoned on January 30, 2017. The Borehole Abandonment Activity Report (Kirtland AFB, 2017a) and NMED approval letter have been included in Appendix E.

A second borehole was drilled for well KAFB-106MW2 approximately 10 feet to the northwest of the original, abandoned borehole. The deviation of this second borehole at 520 feet bgs was measured to be 89.7 degrees, which was approximately 3 feet from plumb, within the project specifications of less than 5 feet deviation over the entire depth of the borehole. All other pilot test boreholes were advanced with minor, acceptable deviations that met specifications.

2.3.3 Extraction Well Installation

Drilling of the extraction wells (KAFB-106EX1 and KAFB-106EX2) began on February 21, 2017 and was completed on March 12, 2017, using Cascade's ARCH drill rig. Well construction was completed in accordance with the Work Plan (Kirtland AFB, 2016a). Well construction diagrams are presented in Appendix D and general construction information for each well is summarized in Table 1.

Each extraction well was installed to a total depth of approximately 537 feet bgs. To minimize the likelihood of aeration of extracted water through water table depression during system operation, the two extraction wells were installed with 15-foot long screens, the top of which are located 10 feet below the static groundwater level. Additional design and construction details for the extraction wells are provided in Table 1 and Appendix D. Well vaults are discussed in Section 2.3.5. A KSPI 700 submersible hydrostatic level transducer was installed in the 1.25-inch PVC drop tube at each extraction well.

2.3.4 Injection Well Installation

Drilling of the injection well (KAFB-106IN1) began on March 16, 2017 and was completed on March 20, 2017, using Cascade's ARCH drill rig. The injection well was constructed in the same manner as the extraction wells (see Section 2.3.3) in accordance with the Work Plan (Kirtland AFB, 2016a); however, the injection well was installed with 20 feet of Schedule 80 PVC, 0.010-inch machine slotted screen, with the top of screen at the static groundwater level and extending 20 feet into the water column. A well construction diagram is presented in Appendix D and general construction information for the well is summarized in Table 1. Similar to the extraction wells, a KSPI 700 submersible hydrostatic level transducer was installed in the 1.25-inch PVC drop tube at the injection well.

2.3.5 Extraction and Injection Well Vaults

Fiberglass well vaults were installed to house extraction and injection wellheads, plumbing, fittings, and remote instrumentation necessary for operation and monitoring of the recirculation system. The floor of each vault consists of a poured concrete slab to provide water containment in the event of a leak. An integrated leak detection sensor was installed in each of the three well vaults, to automatically alert system operators and shut down the system in case of a leak. Each vault is approximately 5 feet long, 4 feet wide, and 3.8 feet deep. Each wellhead is located approximately 6 inches from the wall of the vault, and the top of the sanitary seal is located approximately 8 inches from the concrete floor.

Due to the location of the pilot test area being in an open field, traffic-rated vaults were not required. The upper edge of each vault extends approximately 4 inches above grade to protect the vault from surface runoff water intrusion, and has a hinged, locking cover. The well vaults are protected by four steel concrete bollards located at each corner of the vaults.

2.4 Well Development

Development of the groundwater monitoring, extraction, and injection wells was initiated after drilling and construction of all new wells was completed. Because development close to active drilling could cause poor or incomplete well development of the wells, NMED approved postponement of well development until after completion of all well installation activities in an email dated January 30, 2017 (NMED, 2017). Details regarding development of the monitoring, extraction, and injection wells are discussed in the sections below. Well development logs are provided in Appendix D.

2.4.1 Groundwater Monitoring Well Development

Groundwater monitoring well development was conducted in accordance with the Groundwater Investigation Work Plan (Kirtland AFB, 2011b). Well development consisted of surging, bailing, and pumping to remove fine sediment using a small drill rig equipped with a surge block, stainless steel bailer, and electric submersible pump. Development was considered complete when a turbidity of less than 10 nephelometric turbidity units was achieved for water clarity, at least five well volumes were removed from the well plus any additional water that was added to the well during drilling, and field parameters had stabilized. Field water quality parameters were monitored at regular (5- to 10-minute) intervals during pumping and were considered stabilized when the following criteria were met for three consecutive readings: pH within 0.1 pH units, temperature within 1 degree Celsius, and specific conductance within 10 percent (%). Field data were recorded on well development forms by APTIM scientists, as presented in Appendix D.

Liquid investigation-derived waste (IDW) generated during monitoring well development was stored in 275-gallon totes. Waste management and disposal are discussed in Section 3.11.

2.4.2 Extraction Well Development

The extraction wells were developed using Cascade's well development rig. Wells were developed using a combination of methods including bailing, surging, and pumping. Initial bailing was conducted to remove sediment from the borehole and filter pack prior to beginning well development. After initial bailing, mechanical surging and over-pumping was conducted. Field tests for total solids (by Imhoff cone method) were performed, water levels were monitored, and water quality parameters including turbidity measurements were monitored during development. A constant rate test was performed after initial development was completed. Each well was pumped at approximately 20 gallons per minute (gpm) for a period of no less than 180 minutes. Water levels in the extraction well were manually measured to estimate the specific capacity. Additionally, water levels were manually measured in one observation well to monitor drawdown during constant rate testing.

The extraction wells were developed until well efficiency met at least 70% and had a specific capacity of 3 to 5 gpm per foot, at the discretion of the APTIM scientist. Field data were recorded on well development forms by APTIM scientists, as presented in Appendix D.

Purge water IDW generated during development was transferred to 19,000-gallon Baker storage tanks located within the construction yard. Waste management and disposal are discussed in Section 3.11.

2.4.3 Injection Well Development

The injection well was developed using Cascade's well development rig in the same manner as the extraction wells, as described in Section 2.4.2; however, based on the limited effectiveness and low specific capacity (2.3 gpm per foot) achieved after 120 minutes pumping at a rate of 20 gpm, jetting was conducted to further develop the well. The jetting device consisted of four jets and an extraction pump that was attached to the bottom of the device. Jetting was conducted in 1-foot intervals starting at the top of the saturated screen, working downward. Each 1-foot section of screen was jetted for at least 1 minute.

Imhoff cone and water level readings were collected at a frequency of one minute during jetting activities. A 120-minute constant rate test was performed at the injection well after jetting was completed and indicated that the specific capacity of the well had improved. Field data were recorded on well development forms by APTIM scientists, as presented in Appendix D.

Purge water IDW generated during development was transferred to 19,000-gallon Baker storage tanks located within the construction yard. Waste management and disposal are discussed in Section 3.11.

2.4.4 Pump Installation

Dedicated stainless steel Geotech bladder sampling pumps were originally installed in each of the six groundwater monitoring wells being used for the pilot test (KAFB-106064, KAFB-106063, KAFB-106MW1-S, KAFB-106MW1-I, KAFB-106MW2-S, and KAFB-106MW2-I) in March 2017. Multiple failure points were observed on the Geotech pumps during initial pump testing. After numerous unsuccessful attempts to pull, repair, and/or replace faulty pumps, a decision was made to replace the pumps with QED Environmental Systems (QED) MicroPurge® Model P1101HM bladder pumps with PVC bodies. These new QED pumps were installed in the monitoring wells in September 2017 and baseline samples were recollected (Section 3.3). No operational issues were observed from that point forward, except for minor decreases observed in discharge volumes. Decreased discharge volume is common with bladder pumps as the Teflon™ bladder creases overtime with use and is not able to open to full capacity during recharge/filling.

The QED bladder pumps were hung on a poly-coated stainless steel hanging cable such that the pump intake area was set at approximately the middle point of the saturated screen interval. The top of the pump string includes a single aluminum well cap with access to the discharge line, hanging cable, and air-line. This hanging well cap fits into the top of the sanitary well seal. Well tubing is twin-bonded, Teflon™-lined polyethylene tubing and consists of a ¼-inch outside diameter air supply line and a 3/8-inch outside

diameter water discharge line. During pump installation at KAFB-106MW1-S, measurable NAPL was detected. A discussion of the NAPL and sampling that occurred is discussed in Section 3.2.

In March 2017 following the successful well development, multi-stage centrifugal stainless steel submersible pumps (Grundfos 25S50-26, 5.5 horsepower) were installed in each extraction well. The extraction well pump intakes were set at 497 feet bgs, approximately 20 feet below the water table (as measured during well installation) and 10 feet above the total depth of the well to allow sufficient room for drawdown during pumping. The pumps are attached to approximately 500 feet of 1.5-inch threaded steel pipe, which were attached to a 6-inch sanitary well seal at the top of each well casing. Corrosion of the pumps and pipe materials was minimized through use of corrosion resistant materials and the installation of sacrificial zinc anodes on the drop pipes.

A 6-inch sanitary well seal and a 1.5-inch-diameter threaded steel pipe were installed in the injection well casing to convey water from the piping exiting the system Conex box to the screened interval of the injection well. The injection pipe extended down into the water column and was fitted with a 4-inch diameter, custom designed and fabricated down-hole flow control valve (FCV, manufactured by Baski, Inc.) which provided backpressure to ensure that piping remained full of water throughout the treatment system. This limited the risk of cavitation within the pipe, minimized volatilization of constituents, and minimized aeration of the anaerobic recirculation water. A check valve was installed at the base of the FCV, with an electric submersible pump (Grundfos 5SQE-10-410, 2.3 horsepower) with variable speed frequency drive installed underneath to sample groundwater in the vicinity of the injection well (when the recirculation system was off, and water was not being injected). The injection well sampling pump intake was set at 492 feet bgs, approximately 10 feet above the total depth of the well. Corrosion of the FCV was also minimized through use of corrosion resistant materials and the installation of sacrificial zinc anodes on the drop pipe.

The extraction and injection well pumps were connected to the control room via power supply lines that were run up along-side the drop pipe within the well casing, through the well vault and underground to a conduit stuck-up adjacent to the Conex box. These power supply cables then entered the Conex box and landed on the terminals of the appropriate variable frequency drives. In 2020, downhole equipment (drop pipe, valves, and transducer) and Grundfos pumps were removed from extraction and injection wells (KAFB-106EX1, KAFB-106EX2, and KAFB-106IN1) to assess the condition of the wells and equipment. The well maintenance performed at the extraction and injection wells is discussed in Section 3.7.

2.5 Well Survey

The location and elevation of each well casing was surveyed by a New Mexico-licensed professional land surveyor from High Mesa Consulting Group in accordance with the United States Geological Survey Standard Operating Procedure developed for all monitoring wells on Kirtland AFB (U.S. Geological Survey [USGS], 2016).

Coordinates are based on the North American Datum of 1983 New Mexico State Plane Coordinate System. Elevations are based on the North American Vertical Datum of 1988. The elevation and horizontal location measurements were made to an accuracy of 0.01 and 0.1 foot, respectively. Results of the survey are summarized in Table 1.

2.6 Recirculation Pilot System Equipment and Materials

The pilot test involved multiple test phases requiring recirculation of anaerobic groundwater and addition of tracers and amendments to this water. The equipment necessary to perform the pilot test was installed in the appropriate wells (as detailed above) and a portable shipping (Conex-type) container, and included the necessary pumps, filters, mixers, meters, electrical, and piping to add tracers/amendments and

distribute them in the subsurface (as detailed in this section). The container was also used for security and environmental control and was located adjacent to the well field test area, see Figure 2.

The system for amending and recirculating water was designed by APTIM, together with subcontractors, and was fabricated by Calcon Systems Inc. (Calcon). As discussed in Section 3.1, APTIM and the Calcon performed all necessary system installation, shakedown verification testing (including, but not limited to, pressure testing and alarm functionality testing), and start-up tasks. The system as-built drawings and component specification sheets are presented in Appendix F.

A 20-ft long Conex box was used to house the recirculation and tracer/ amendment delivery system components. Figure 5 presents a schematic of the Conex box treatment system. The box has a partition wall, separating the enclosure into two spaces. The smaller of the two spaces is the system control room, which is rated as a non-hazardous atmosphere, and houses the supervisory control and data acquisition (SCADA) system with integrated computer, electrical control panel, Baski FCV controls and associated nitrogen cylinder, and a combination air conditioner/heater. The larger space, which includes the recirculation water piping/fittings, flowmeters, pressure transmitters, tracer/amendment tanks, chemical feed pump, and other system process components, is rated as a Class 1, Division 2 atmosphere, due to the possible presence of fuel hydrocarbons in the recirculation water flowing through the piping in this portion of the enclosure. All electrical components and connections in this portion of the enclosure are intrinsically safe to meet the hazardous atmosphere classification. This space also contains a floor leak sensor, which continuously monitors for water on the floor of the enclosure (in the case of a pipe failure or other leak), having the ability to shut down the system and notify appropriate personnel in the case of an alarm condition.

The main components of the recirculation system are identified on a process flow diagram (see Figure 6), while a more detailed design is presented on the piping and instrumentation diagram (P&ID), which is

shown on Figure 5. To maintain the anaerobic conditions of the groundwater and aquifer and to prevent the loss of volatile components within the groundwater, the system was designed to minimize gas exchange between the recirculated groundwater and the atmosphere. The system was designed to extract groundwater from the two extraction well locations and reinject that groundwater in the injection well after tracer or amendment addition, at a design flow rate of up to 24 gpm. This design flow rate was achieved by the system, but operational flowrates changed during the pilot test based on tracer results and other site conditions, as discussed further in Section 3.

Electrical power for system operation was supplied by on-base grid power through an electrical line that runs from the power source on the east side of the site to the recirculation system (see Figure 2). A 480-volt, 3-phase electrical service was required to operate the 60-horsepower extraction well pump motors. APTIM worked with base civil engineering personnel and a licensed electrical subcontractor to procure and install the necessary transformer and underground service line to the main disconnect switch on the system enclosure (Conex box). Trenching of the main power supply cable to the Conex box was required. Appropriate dig and base civil engineer permits were acquired prior to starting. Trenching and installation of the electrical power line was completed from April 17 to April 21, 2017. The electrical line was installed in a 3-foot deep trench. The route of the electrical power line is presented on Figure 2.

The treatment system includes a SCADA system for remote monitoring of flow rates and other parameters, to compliment on-site adjustments and regular operation and maintenance. Process instrumentation, including pressure, level, and flow gauges/switches, were installed at critical locations in the system, as shown on the P&ID (Figure 5), to ensure safe and controlled operation. The programmable SCADA and logic controllers contain the process control logic to monitor and regulate the operation of the various system components, both locally and remotely. The SCADA enables the application of power to the pumps, regulates flowrates, pressures and operation of the FCV, while continuously monitoring the system safety interlocks and making emergency call outs when the system was offline or in alarm mode.

Water conveyance pipelines connecting the Conex box to the extraction and injection wells were installed in trenches approximately 4 feet deep (below the frost line). The underground conveyance piping consists of double containment system that houses the 2-inch piping. The conveyance piping, injection valve pneumatic tubing, pump electrical leads, well vault leak detection wire, Baski nitrogen line, and water level transducer wire leading from the Conex box to the wells are all located within the trenches. Where extraction and injection well piping breaches the ground surface and enters the container (above grade), the piping transitions to 1.5-inch single-walled Schedule 80 PVC, and was insulated to prevent freezing. Trenching began in April 2017 and well pipelines were connected to the system container and pressure tested on April 20, 2017.

Groundwater extraction occurred through the use of electric submersible well pumps (Grundfos 25S50-26) with variable speed frequency drives. Each of the two 4-inch-diameter pumps are fully submersible and capable of maintaining design flows. The variable speed frequency drives were controlled by input values from the SCADA system to fine tune motor operation to adjust flow rates, as needed. Once groundwater was extracted from each of the two extraction wells, it was directed through a pair of particle filters prior to combining flows. These filters were used to prevent undesired particulates from entering the amendment and reinjection portions of the system. Generally, 100-micron (μm) polyethylene woven (poly-woven) filters were used in the lead canisters, while 50- μm poly-woven filters were used in the lag canisters. During system operation, it was determined that the 100- and 50- μm filters had a longer operation lifetime. Earlier use of 50- and 20- μm pleated cellulose filters at the onset of the demonstration resulted in frequent filter changes and quick pressure build-up. The change to poly-woven filters with larger nominal pore sizes significantly improved filter runtimes.

Bourdon tube pressure gauges and switches were installed on the upstream side of the particle filters (as shown on the P&ID, Figure 5), between filters, and on the downstream side of the filters to sense back pressure on the filters. The SCADA system had two alarm set points associated with these pressure

switches. The first (high pressure alarm) was an indicator to the system operator that the filters are in need of cleaning/changing, while the second (high-high pressure alarm) shuts-down the system until the filters are cleaned/changed and the system was manually restarted. The poly-woven filters were housed within 20-inch polypropylene Pentek canisters that are pressure rated to 100 pounds per square inch. ProSense® pressure transmitters are installed along the aboveground extraction well piping, upstream of the filters. Additionally, a pressure transmitter was connected to the injection well manifold within the well vault. These monitored the pressures of the system and are connected to the SCADA. Once the groundwater exits the filters from each pipeline, the flows from each extraction well was combined into one 2-inch Schedule 80 PVC pipeline that discharged to the injection well.

Signet 2551 Magmeter flow meters were installed along each extraction and injection well pipeline, just downstream of the filters (three flow meters, one on each pipeline). Totalizing meter installation reports, calibration documentation, and specification sheets were submitted to the OSE, as required by the Change of Water Rights Conditions of Approval for permitted wells RG-1579 POD316 through POD318. This documentation is contained in Appendix C.

Prior to reaching the injection well, extracted groundwater was mixed with either tracers or other amendments (depending on the phase of operation, as discussed in Section 3) using an amendment delivery system consisting of a 550-gallon amendment tank, control valves, pressure gauges, positive displacement variable speed metering pumps (chemical feed pump; LMI E711-368SI), and a pressure regulating tank.

The amendment tank was fitted with an EchoSonic® ultrasonic level sensor that was programmed with the SCADA. The level sensor was a non-contact sensor installed on the top of the amendment tank. The tank has an 8-inch opening with vented lid. Mixtures of water and fluorescein/deuterated water tracer or water and sodium lactate, diammonium phosphate (DAP), and potassium iodide (KI) were batched/mixed

within the amendment tank prior to distribution, via the chemical feed pump, into the injection well piping. Tracer/amendment storage and mixing is further discussed in Section 3. The amendment tank was fitted with an outlet port and tubing that connects to the chemical feed pump and calibration column (4,000 milliliter graduated cylinder). The calibration column was connected to the chemical feed pump via a gate valve and tubing connections. Pump tests were performed using the calibration cylinder and deionized (DI) water to determine and dial-in the appropriate flowrate of the chemical feed pump. The chemical feed pump was used to pulse concentrated amendment solution from the amendment tank into the injection well piping. This in-line injection allowed for introduction of amendments to the recirculation water stream under pressure.

After concentrated amendment solution entered the injection well piping, it flowed through a 19-inch PVC static mixer to help dilute and mix the amendments with the groundwater (Figure 6). A 31.8-gallon HydroPro pressure tank was connected to the recirculation piping within the system container, to regulate the pressure spikes within the recirculation system. A wall-mounted Rosemount™ pressure transmitter was connected to the pressure tank piping.

A down-hole FCV and submersible pump, both installed in the injection well (as discussed in Section 2.4.4), was controlled by input values from the SCADA system, as needed. The system was designed to shut down automatically if the water level transducer in the injection well indicated that the water level in the well casing has risen to a predetermined level, or if the water level transducer in one or both of the extraction wells indicated that the water level has dropped to within approximately 2 feet of the top of the extraction well screen.

The Conex box was pre-fabricated by Calcon at their facility in San Ramon, California and delivered on April 13, 2017 to the pilot test site. Final design as-builts and specification sheets for system components are included in Appendix F.

3. PILOT SYSTEM OPERATION AND MONITORING

The pilot testing was performed in four phases. The duration and a timeline of each of these phases are summarized in Table 2. Data were collected and evaluated during each phase of the pilot test and the results were used to adjust each phase duration, as needed. The first phase (Phase 1) started after installation, development, and testing of the wells and equipment associated with the Pilot Test System. Phase 1 included an evaluation of baseline conditions, and operation of the recirculation system while performing a tracer test to evaluate distribution of injected water in the subsurface. The second phase (Phase 2) included an evaluation of biostimulation on EDB degradation through operation of the recirculation system and the addition of nutrients and a fermentable substrate to the subsurface. The third phase (Phase 3) of the pilot testing was originally proposed to include bioaugmentation with an exogenous debrominating culture (SDC-9), and an evaluation of enhanced EDB degradation. However, as discussed in Section 3.6, bioaugmentation was deemed not necessary based on results during Phase 2, and a further evaluation of biostimulation was performed as Phase 3. The modified Phase 3 was approved by the NMED in a letter dated August 7, 2018 (NMED, 2018), which also stated that “bioaugmentation shall remain as an approved, but deferred component of the pilot test”. The fourth and final phase (Phase 4) continued groundwater monitoring without recirculation or addition of amendments. Phase 4 monitoring was concluded in October 2020. For reference, Safety Data Sheets (SDSs) for all tracers and amendments used during the pilot test are included in Appendix G.

3.1 Pilot System Start-up Testing

Final electrical and piping connections, including power and control wiring between the Conex box control panel and the extraction/injection well pumps and vault control components/sensors, and final pipe connections between the stubbed-up extraction/injection well piping and the Conex box were made by Calcon and APTIM from May 11 through 16, 2017. Shakedown testing of the Pilot Test System, which included testing the extraction well pumps; pressure and flow transmitters; leak detection and level

sensors; chemical feed pump; Baski FCV and control system; injection well sample pump; remote telemetry; and alarm interlocks was performed on May 16 and 17, 2017 prior to full system start-up. There were no notable operational issues with the system during shakedown testing, with all interlocks and associated alarms working properly. The Pilot Test System was started on June 29, 2017 during the first baseline sampling event at the extraction and injection wells. The Pilot Test System was restarted and retested on September 26, 2017, after a three-month project delay caused by faulty monitoring well sampling pumps (discussed in Section 2.4.4) and just prior to initiation of tracer testing (Phase 1).

3.2 2017 NAPL Sampling

Measurable NAPL was detected in the shallow nested well KAFB-106MW1-S during QED pump installation on September 5, 2017. Three separate measurements were collected using a Solinst oil-water interface probe and confirmed a thickness of approximately 0.27 to 0.31 feet. NAPL was not detected at any other shallow monitoring wells within or around the treatment zone, or in the injection well on September 5, 2017. The extraction wells were not gauged for NAPL at this time, as the top of the well screens were designed to be installed below the static water level. Well KAFB-106MW1-S was bailed on September 8, 2017 and approximately 60 milliliters of product were recovered. The product was containerized and submitted to Pace Analytical® (Pace) for the following analysis:

- C3-C12 PIANO Quantitative Molecular Characterization by gas chromatography-mass spectrometry (VOC Fingerprinting)
- C8-C40 Full Scan Qualitative Molecular Characterization by gas chromatography-mass spectrometry (semivolatile organic compound Fingerprinting)
- Density and Viscosity

Density and viscosity analyses were subcontracted to Clark Testing. Additional product recovery occurred on September 13 and 14, 2017, and approximately 60 milliliters sent to the APTIM Biotechnology Development and Applications Group in Lawrenceville, New Jersey to facilitate EDB compound-specific isotope analysis (CSIA) efforts funded under Environmental Security Technology Certification Program (ESTCP). NAPL has not been detected in KAFB-106MW1-S since October 2017 (Table 3), but KAFB-106MW1-S was continually monitored for its presence on a weekly basis.

The NAPL analysis by Pace indicated a great variety of hydrocarbons, but notably benzene (31.8 milligrams per kilogram [mg/kg]) and EDB (20.5 mg/kg) concentrations were low compared to toluene (7,396 mg/kg) and ethylbenzene (6,098 mg/kg). This laboratory report is included in Appendix I-3. The delta carbon-13 ($\delta^{13}\text{C}$) value of EDB in the NAPL, as determined by the University of Oklahoma, was approximately -21 ± 2 per mil (‰). Brief discussion of the carbon isotope composition of EDB in the NAPL is provided in Section 4.5.2.

The fall and rise of the water table during well installation and development may have impacted the vertical transport and subsequent distribution of NAPL in the lower vadose zone, capillary fringe, and top of the unconfined aquifer; causing the measurable NAPL at KAFB-106MW1-S.

3.3 Baseline Sampling

Initial baseline sampling occurred from June 29 through August 16, 2017 using Geotech dedicated bladder pumps at the monitoring wells and submersible Grundfos pumps at the extraction and injection wells. During this time, KAFB-106MW1-S was not sampled due to numerous pump failures (Section 2.4.4). Baseline samples were recollected for all analyses except for Microbial Insights QuantArray-Chlor from September 18 through September 26, 2017. All pilot test wells were sampled prior to Phase 1 recirculation activities to establish pre-test baseline conditions. Purged groundwater was passed through a flow-through cell equipped with a YSI™ ProDSS multi-parameter water quality meter

for evaluation of geochemical stabilization parameters (pH, dissolved oxygen [DO], oxidation-reduction potential [ORP], temperature, and specific conductivity). Turbidity was measured with a Hach™ Model 2100Q turbidity meter. Water quality meters were calibrated prior to each sampling event, in accordance with manufacture's recommendations. Table 3 summarizes the field water quality measurements collected prior to sampling. Table 4 presents the suite of analytes that were measured by the certified analytical laboratories and the sampling frequency. An evaluation of baseline and other analytical testing results are presented in Section 4.

3.4 Phase 1 – Tracer Testing

The purpose of Phase 1 was to evaluate baseline conditions and the distribution of recirculated water using tracer amendments. Groundwater (without biostimulation or bioaugmentation amendments) was extracted from the two extraction wells at flow rates of 10 gpm from each well, combined, and after tracers were added (during a 24-hour period), the water was reinjected back into the subsurface at the injection well. The recirculation portion of Phase 1, which was conducted for four weeks from October 2 to November 3, 2017, distributed injected water throughout the pilot testing zone and established new experimental baseline measurements for comparison to later biostimulation phases. The passive portion of Phase 1 began on November 3, 2017, upon shutdown of the recirculation system, and concluded on December 21, 2017.

During Phase 1, two conservative (i.e., non-reactive) tracers of water flow were used to evaluate subsurface transport characteristics. The two tracers used were fluorescein and water labeled with additional deuterium, a stable isotope (i.e., non-radioactive) of hydrogen (Appendix G). Prior to injection, the fluorescein and deuterated water were homogenized with 22 gallons of deionized water in a 55-gallon drum. The drum was plumbed to the inlet of the chemical feed pump via 3/8-inch diameter polyethylene tubing. Over a period of approximately 24 hours, from October 2 through 3, 2017, approximately 54 grams of fluorescein and 15 kilograms of deuterium oxide ($^2\text{H}_2\text{O}$) were injected into the treatment

zone through the recirculated groundwater. During the entire Phase 1 recirculation period, approximately 887,000 gallons of water were extracted and reinjected.

During Phase 1 recirculation system operation, increased back pressure upstream of the sediment filters at pressure transmitters PIT-103 and PIT-109 (Figure 5) was observed, caused by an increased loading on the filters, resulting in more frequent filter changes than was originally anticipated, with KAFB-106EX1 experiencing a faster sediment loading rate. Initially, sediment was observed on the 10-inch long pleated cellulose filters CF-1-1 and CF-1-3; though this diminished in the short-term. A number of what appeared to be biological masses were also observed on filters during this time. Several approaches were used to mitigate the heavy filter loading and frequent filter change-out rate by increasing the effective filter surface area. The 10-inch long canister housings at CF-1-1 through CF-1-4 were replaced with 20-inch long canister housings, and woven polyethylene filter cartridges replaced the existing pleated cellulose. During the majority of Phase 1, 100- and 50- μm woven polyethylene filters were ultimately used on both extraction well lines in the lead and lag positions, respectively, with much improved runtimes.

Water level readings in the extraction and injection wells were continuously monitored by the SCADA system and monitored manually periodically. During recirculation system operation, it became apparent that the water level readings from pressure transducers located in the extraction well drop pipes were not accurate. The likely cause of the inaccurate readings was electrical interference from the extraction well pumps' power leads running down the well to the pump near the drop tubes where the transducers and their control wires were housed. As a result, manual water level readings were periodically measured using the Solinst water level meter to avoid unnecessarily drawing down below the top of the screened interval in the extraction wells. Manual water level readings are summarized in Table 5.

Eight groundwater sampling events designed to quantify transport properties during active recirculation were conducted during Phase 1, with two additional sampling events conducted approximately 2 and

4 weeks after recirculation activities ceased. Groundwater fluorescein concentrations and delta deuterium (measure of hydrogen isotope composition) ($\delta^2\text{H}$) values were determined for these samples. In addition, groundwater measurements were collected during one subset of the recirculation sampling events (Day 23, collected on October 24 and 25, 2017) to determine baseline conditions for the other analytes presented in Table 4.

Groundwater samples were collected intermittently at extraction, injection, and the six groundwater monitoring wells during the active portion of Phase 1, and biweekly during the passive portion. KAFB-106MW1-S/I, KAFB-106MW2-S/I, KAFB-106064, KAFB-106063, KAFB-106EX1, KAFB 106EX2, and KAFB-106IN1 were sampled using either dedicated QED MicroPurge® Model P1101HM bladder pumps (monitoring wells) or the down-hole extraction pumps or injection well sampling pump (the injection well was not sampled during active recirculation). Prior to purging, depth to water measurements and depth to NAPL (if present) were collected at groundwater monitoring wells KAFB-106MW1-S, KAFB-106064, and KAFB-106063; extraction wells, and the injection well. Water level measurements were also collected during purging to monitor for drawdown. Water levels were measured using a portable water level indicator and interface probe (Solinst). Both manual water level measurements (Solinst probe) and transducer measurements were collected from extraction and injection wells. Due to the size of the well casing and placement of the dedicated tubing bundle, water level measurements could not be obtained from KAFB-106MW1-I, KAFB-106MW2-I, and KAFB-106MW2-S. The field water quality parameters, NAPL, and water level measurements were recorded on the purge logs for each well. Purge logs and sample collection logs are included as Appendix H.

Each well was purged to remove stagnant water from the well in order to collect a representative groundwater sample. Purged groundwater passed through a flow-through cell equipped with a YSI™ ProDSS multi-parameter water quality meter for evaluation of geochemical stabilization parameters (pH,

DO, ORP, temperature, and specific conductivity). Turbidity was measured with a Hach™ Model 2100Q turbidity meter. Purging continued until three stable field measurements for DO, pH, ORP, specific conductivity, temperature, and turbidity were obtained. Stabilization criteria for field measurements were three consecutive readings within 10% of each other. Water quality meters were calibrated prior to each sampling event, or after anomalous readings were observed. Samples from the extraction and injection wells were collected from sample ports located along the system piping, upstream of the sediment filters. Table 3 summarizes the field water quality measurements collected prior to sampling. Table 4 presents the suite of analytes that were measured by the certified analytical laboratories. Both hydrogen and carbon isotopes were reported using (δ) notation, where $\delta^2\text{H}$ or $\delta^{13}\text{C} = R_{\text{sample}}/R_{\text{standard}} - 1$ and R is the $^2\text{H}/^1\text{H}$ or $^{13}\text{C}/^{12}\text{C}$ ratio of the sample and the standard (Vienna Standard Mean Ocean Water for $\delta^2\text{H}$, and Vienna Pee Dee Belemnite for $\delta^{13}\text{C}$), respectively. Note that the commonly included multiplier of 10^3 has been omitted from the equation but should be incorporated to report δ values as ‰. CSIA of EDB in samples was performed by Dr. Tomasz Kuder at the University of Oklahoma, through funding provided by ESTCP Project ER-201331.

Ten sampling events were conducted during Phase 1. Additionally, three samples were collected from the injection well sampling port, which was representative of the groundwater being injected on October 2 and 3, 2017. Fluorescein and $\delta^2\text{H}$ data suggested good hydrologic control and connectivity at the test site. Tracer testing results are further discussed in Section 4.

3.5 Phase 2 – Biostimulation

The purpose of Phase 2 was to evaluate biostimulation in the subsurface after distribution of treatment amendments in recirculated groundwater. Phase 2 consisted of two operational periods, a recirculation/mixing (active) period, and a subsequent passive monitoring period (no recirculation). During the recirculation period, groundwater was extracted and an easily fermentable sodium lactate-based substrate (WilClear Plus®, manufactured by JRW Bioremediation), nutrient (DAP), and

conservative tracer (KI) were added to the recirculated process water stream. The amended water was reinjected to distribute the amendments throughout the pilot testing zone. The goal of these amendments was to stimulate activity of native microbial populations capable of debrominating EDB. For reference, SDSs for the amendments are included in Appendix G.

Upon completion of the passive Phase 1 monitoring period, the recirculation system was restarted on December 11, 2017 and allowed to run at extraction rates of 10 gpm (each well) prior to introducing amendments. The active portion of Phase 2 began on December 21, 2017 with the injection of treatment amendments for biostimulation and continued until February 7, 2018. A concentrated solution of the amendments was prepared in the amendment mixing tank (AT-1, see Figure 5) and added to the process stream by the chemical feed pump manufactured by LMI (P-2-1).

The concentrated amendment solution was prepared using water obtained from the Kirtland AFB potable water plant located on Texas Drive and transferred to the project site in 275-gallon totes. The water was transferred from the totes into the amendment tank via a sump pump and garden hose. Volume marks on the tank were used to bring the water up to the desired level. DAP and KI were weighed using a kitchen scale and poured into the tank. The sodium lactate was pumped from 55-gallon drums into the tank using a drum pump and tubing. A Goulds submersible mixing pump was deployed within the amendment tank to mix the amendments and keep the constituents in solution. During this homogenization, specific conductivity in the tank was measured at regular intervals until it was determined that the readings had stabilized. After reaching stabilization, the chemical feed pump was turned on to start amendment injection. During operation, amendment delivery into the recirculation water process stream, and subsequently delivered to the injection well, was pulsed such that there were periods of time when the recirculation process water contained amendments and other times flow contained only recirculated groundwater. The pulsed amendment injection scenario was implemented to minimize biofouling in the injection well by flushing the well screen and filter pack with water less conductive to biological growth

and fouling. Additional batches of amendments were mixed once the level within the amendment tank reached a predetermined low level. A new batch was typically mixed every 4 to 7 days during recirculation. Over the approximately 7-week active injection period in Phase 2, approximately 290 gallons of WilClear Plus®, 150 kilograms of DAP, and 71 kilograms of KI were injected into the treatment zone. Table 6 summarizes the injected quantities for each Phase of the pilot test. The targeted concentration of fermentable substrate (300 mg/L) was consistent with that outlined in Work Plan (Kirtland AFB, 2016a), albeit using broader diversity of fermentable substrates rather than lactate alone. The targeted concentration of DAP (50 mg/L) was approximately half that of the Work Plan due to concerns regarding precipitation of solids. These targeted concentrations were consistent with contractor experience, typical substrate loading rates (AFCEE et al., 2004), and treatability testing performed using site materials (100 mg/L lactate and 50 mg/L DAP). The targeted KI concentration was consistent with the Work Plan (Kirtland AFB, 2016a). During the entire Phase 2 recirculation period, approximately 1,467,000 gallons of water were extracted and reinjected, but due to testing of the system and the challenges described in the following paragraph, only approximately 927,000 gallons were recirculated during the period that carbon substrate, DAP, and KI were introduced.

Approximately two hours after amendment injection began on December 21, 2017, a leak was observed originating from the chemical feed pump. The system was shut down and the chemical feed pump head and four-way valve were dismantled to determine the cause of the leak. Small crystals were observed within the check ball housings and on the check balls within the four-way valve. The affected areas were cleaned with cotton swabs and deionized water, reassembled, and the system was restarted. During a system check on December 23, 2017, it was observed that while the chemical feed pump was running, no amendment fluid was being conveyed through the tubing to the injection point on the recirculation process piping. Coincident to this, an increase in mounding (up to 9 feet above static [476 feet bgs]) at the injection well was observed. The system was shut down to diagnose and rectify the crystallization issue. It was determined that amendment concentrations needed to be decreased in the amendment tank. Lower

amendment concentrations and running the chemical feed pump more frequently rectified the crystallization issue, and facilitated the introduction of amendments at target rates. Introduction of amendments using the new concentrations began on December 29, 2017. The active portion of Phase 2 was extended until February 7, 2018 to deliver the planned mass of amendments.

During Phase 2, approximately 11 feet of water level drawdown was observed at KAFB-106EX2 during active Phase 2 system operations. The flowrate at KAFB-106EX2 was incrementally reduced to 7 gpm beginning on January 8 through January 22, 2018 to prevent drawdown of water below the top of the screened interval. Extraction well KAFB-106EX1 did not display a similar drawdown trend, and thus, remained at 10 gpm throughout Phase 2. Table 5 presents the measured water levels and flowrates for the two extraction wells during Phase 2.

The passive portion of Phase 2 began on February 7, 2018, when the recirculation system was shut down, and concluded in July 2018. After the chemical feed pump was turned off and injection of the amendments ceased, the extraction wells were allowed to run for several hours to flush the injection well screen and filter pack. During the passive period of Phase 2, groundwater in the treatment zone was monitored for approximately 4 months to evaluate whether EDB degradation was enhanced (as further described in Section 4).

Groundwater samples were collected on a weekly basis during active recirculation and on a monthly basis during the passive portion of Phase 2 at extraction, injection, and monitoring wells, to evaluate the effectiveness of biostimulation. An additional passive sampling event was conducted, resulting in seven total sampling events for Phase 2. Groundwater sampling was performed as described in Section 3.4. Table 3 summarizes the field water quality measurements collected prior to sampling. Table 4 presents the suite of analytes measured by the certified analytical laboratories. An evaluation of the Phase 2 sampling results is presented in Section 4.

3.6 Phase 3 – Biostimulation

As described in the Work Plan (Kirtland AFB, 2016a), Phase 3 originally included a recirculation period that included both biostimulation and bioaugmentation. The Work Plan proposed that the biostimulation-portion of Phase 3 be similar to Phase 2 and that a debrominating bioaugmentation culture (SDC-9) would be injected into KAFB-106IN1 and distributed with the recirculation system. As presented in the *Phase 3 Ethylene Dibromide In Situ Biodegradation Pilot Test Notification Letter, Bulk Fuels Facility, Kirtland AFB, New Mexico* (Kirtland AFB, 2018a), after evaluating analytical data from the passive period for Phase 2, it became evident that the rate of anaerobic EDB biodegradation was significantly enhanced as a result of biostimulation, and that bioaugmentation was not warranted as a part of Phase 3. Analytical results from the passive period of Phase 2 were discussed in the letter. NMED approved removal of bioaugmentation from Phase 3 in their letter dated August 7, 2018 (NMED, 2018), concluding that bioaugmentation remain an approved, but deferred, component of the pilot test.

Therefore, similar to Phase 2, the purpose of Phase 3 was to continue to evaluate biostimulation in the subsurface after distribution of treatment amendments in recirculated groundwater. Phase 3 also consisted of two operational periods, a recirculation/mixing (active) period, and a subsequent passive monitoring period (no recirculation). During the recirculation period, groundwater was extracted and WilClear Plus® and DAP were added to the process water stream before reinjecting it to distribute the amendments throughout the pilot testing zone.

Upon completion of the passive Phase 2 monitoring period, the active portion of Phase 3 began on July 30, 2018, with the groundwater extraction rates of 10 gpm at KAFB-106EX1 and 7 gpm at KAFB-106EX2. The injection of treatment amendments for biostimulation continued until September 9, 2018. A concentrated solution of the amendments was prepared in a similar fashion to that in Phase 2 (discussed in Section 3.5). A pulsed amendment injection scenario was again implemented in an attempt to minimize biofouling in the injection well. Over the approximately 5-week active injection period in

Phase 3, approximately 340 gallons of WilClear Plus® and 143 kilograms of DAP were injected into the treatment zone. Table 6 summarizes the actual injected quantities for each Phase of the pilot test. During the entire Phase 3 recirculation period, approximately 926,000 gallons of water were extracted, amended, and then reinjected.

The water table drawdown measured at KAFB-106EX2 during the active portion of Phase 2 became apparent again during Phase 3 system operations (as shown on Figure 7). The extraction flow rate at KAFB-106EX2 was incrementally reduced from 7 to 4 gpm during Phase 3 (beginning on August 6 through August 30, 2018) to prevent drawdown of water below the top of the screened interval. Extraction well KAFB-106EX1 remained at 10 gpm during Phase 3. Increased mounding was also observed throughout the active portion of Phase 3 at the injection well (see Figure 7), increasing to approximately 35 feet above the static level by the end of Phase 3 active recirculation.

The recirculation system was shut down on September 9, 2018, initiating the passive portion of Phase 3 that concluded on November 19, 2018. After the chemical feed pump was turned off and injection of the amendments ceased, the extraction wells were allowed to run for several hours to flush the injection well screen and filter pack. During the passive period of Phase 3, groundwater in the treatment zone was monitored for approximately 3 months to evaluate whether EDB degradation was enhanced (as further described in Section 4).

Groundwater samples were collected weekly during active recirculation and monthly during the passive portion of Phase 3 at extraction, injection, and monitoring wells to evaluate the effectiveness of biostimulation. An additional recirculation sampling event was conducted, resulting in seven sampling events for Phase 3 (Table 4).

During the first Phase 3 passive sampling event (September 2018), the injection well sampling pump mounted below the FCV failed to pump water to the surface. After approximately 40 minutes of pumping, the water level in the well was manually checked and found to have drawn down below the transducer to the level of the pump intake (492 feet bgs). Thus, it seemed the loss of well capacity suggested by the increased mounding at the injection well (shown on Figure 7) was preventing groundwater from flowing into the well to sustain pumped flow to the surface; likely due to fouling of the well screen. Fine sand, silt, and grey biological-like growth were observed on the transducer cable and probe when it was pulled to collect manual water level measurement. As a result, of the decreased well capacity, sample collection using the injection well pump was no longer possible, and samples from KAFB-106IN1 were collected using a 0.85-inch by 36-inch stainless steel bailer lowered to the groundwater through the transducer drop tube. Samples were collected with the bailer during the Phase 3 passive sampling events conducted on October 4 and November 19, 2018.

Groundwater sampling methods were performed as described in Section 3.4. Table 3 summarizes the field water quality measurements collected prior to sampling. Table 4 presents the suite of analytes measured by the certified analytical laboratories. An evaluation of Phase 3 sampling results is presented in Section 4.

3.7 Phase 4 – Extended Monitoring

Phase 4 consisted of continued groundwater monitoring with no active recirculation and began upon completion of the final Phase 3 sampling event on November 19, 2018. The recirculation system was not operated during Phase 4, except briefly during extraction well sampling during the January 2019 monitoring event. During this Phase and in accordance with the Work Plan (Kirtland AFB, 2016a), groundwater samples are to be collected regularly at extraction, injection, and monitoring wells to evaluate the performance of the technology and quantify any rebound of EDB. One sampling event was conducted as a part of Phase 4 in 2019, from January 16 through January 21. This sampling event

occurred approximately 2 months after the Phase 3 passive period was concluded, in accordance with the Work Plan (Kirtland AFB, 2016a). After a period of time that allowed for greater water infiltration into the pilot test area, sampling of the groundwater monitoring, extraction, and injection wells resumed in March 2020 after the extraction and injection well pumps were removed and the wells surveyed with a camera to assess downhole equipment and well conditions. Starting in 2020, samples were collected quarterly and analyzed for the same constituents as approved in the Work Plan (Kirtland AFB, 2016a). Extraction and injection well maintenance activities are discussed in the following subsections. Phase 4 monitoring continued through October 2020 and a total of five sampling events were conducted during Phase 4. Groundwater sampling methods were performed as described in Section 3.4; however, samples were collected using dedicated bladder pumps rather than Grundfos pumps at the two extraction wells and injection well in 2020. Table 3 summarizes the field water quality measurements collected prior to sampling. Table 4 presents the suite of analytes measured by the certified analytical laboratories. An evaluation of Phase 4 sampling results through 2020 is presented in Section 4.

3.7.1 Extraction and Injection Well Maintenance

To assess the condition of extraction and injections wells of the pilot test (KAFB-106EX1, KAFB-106EX2, and KAFB-106IN1), well manifolds and all downhole equipment (drop pipe, valves, transducer, and pump) were removed and video camera survey was performed.

The downhole well infrastructure from KAFB-106EX1, KAFB-106EX2, and KAFB-106IN1 were removed by a drilling subcontractor using a pump rig from January 27 through January 30, 2020. All three wells were video surveyed on February 13, 2020. The video showed that KAFB-106IN1 had moderate to severe build-up of viscous semi-solid materials throughout most of the screened interval. Video logs from the two extraction wells (KAFB-106EX1 and KAFB-106EX2) showed minor build-up on the screen slots. This type of buildup is commonly observed with *in situ* remedial projects, as a result from microbial growth. Both extraction wells contained a yellow-orange liquid floating on the water

surface, which was interpreted to be NAPL. The thickness of the suspected NAPL was visually estimated during video logging to be 0.5 feet at KAFB-106EX1 and 12 feet at KAFB-106EX2. The presence of NAPL was confirmed with a Solinst oil-water interface probe on February 17, 2020, when the NAPL thickness was measured at 11.2 feet at KAFB-106EX2 and 0.65 feet at KAFB-106EX1. No NAPL was present in KAFB-106IN1. A dedicated QED MicroPurge® Model P1101HM bladder pump was installed in KAFB-106IN1 on March 4, 2020.

3.7.2 2020 NAPL Removal Activities

NAPL was bailed by hand from KAFB-106EX1 and a dedicated QED MicroPurge® Model P1101HM bladder pump was installed on March 4, 2020 to resume quarterly sampling activities. The pump was subsequently removed from KAFB-106EX1 to allow for NAPL removal via a large mechanical bailer. Pump installation and groundwater sampling was delayed at KAFB-106EX2 to avoid coating the dedicated pump with NAPL and to allow for collection of representative groundwater samples without bias that can be caused by an NAPL source present in the well.

On June 30 and July 1, 2020 a large bailer operated by a pump rig was used to remove NAPL from extraction wells KAFB-106EX1 and KAFB-106EX2. NAPL was effectively removed using the large bailer, with less than a tenth of a foot remaining. Approximately one gallon was removed from KAFB-106EX1 and 16 gallons were removed from KAFB-106EX2. A dedicated QED MicroPurge® Model P1101HM bladder pump was installed in KAFB-106EX2 on July 1, 2020 and sampling of KAFB-106EX2 resumed during third quarter 2020. KAFB-106EX2 was not sampled during previous quarters in 2020 to avoid coating the dedicated pump with NAPL during pump installation and to allow for collection of representative groundwater samples without bias that can be caused by an NAPL source present in the well. The dedicated bladder pump was also reinstalled in KAFB-106EX1 on July 1, 2020.

Once mechanical NAPL removal activities were completed, the shallow groundwater monitoring wells and injection well (KAFB-106IN1) were gauged for NAPL using a Solinst Model 122 oil-water interface probe. Two of the three shallow groundwater monitoring wells (KAFB-106MW1-S and KAFB-106MW2-S) and the injection well (KAFB-106IN1) are screened within the vadose zone (screens intersect the current water table). Groundwater monitoring well KAFB-106064 has a submerged screen. NAPL was not observed during this gauging event at the injection well or surrounding shallow groundwater monitoring wells.

To further remove possible trace NAPL from extraction wells KAFB-106EX1 and KAFB-106EX2, absorbent socks were installed in both wells on September 22, 2020 and socks remained emplaced for several weeks. The absorbent socks were removed from both extraction wells on October 1, 2020 and a Solinst oil-water interface probe was used to evaluate NAPL presence. NAPL was not detected in either KAFB-106EX1 or KAFB-106EX2 after the absorbent socks were removed.

It should be noted that the goal of the pilot test was not to treat or characterize the nature and extent of NAPL. NAPL characterization efforts are included in the Source Zone Characterization Report that will be revised for delivery to NMED in April 2021.

3.8 Sample Analysis

All sampling activities were conducted in accordance with Sections 5.2.4 and 5.2.5 of the Groundwater Investigation Work Plan (Kirtland AFB, 2011b), and the site-specific Quality Assurance Project Plan, which is an appendix to the Groundwater Investigation Work Plan. Evaluation of EDB carbon isotopes was performed by CSIA as part of a U.S. Department of Defense ESTCP Project ER-201331 entitled, “Natural Attenuation and Biostimulation for *In Situ* Treatment of 1,2-Dibromoethane (EDB).” The

monitoring, extraction, and injection wells were sampled for baseline conditions in June 2017. Samples were submitted for the following analyses:

- VOCs (United States Environmental Protection Agency [EPA] Method 8260B)
- EDB (EPA Method 8011)
- Dissolved iron and manganese (EPA Method 6010C)
- Anions – bromide, nitrate, nitrite, chloride, and sulfate (EPA Method 9056A)
- Nitrate and nitrite as nitrogen (EPA Method 353.2)
- Iodide (EPA Method 300.0)
- Reduced Gases (RSK SOP-175; EPA 3810)
- Volatile Fatty Acids (EPA Method 300 Modified)
- Alkalinity (Standard Method 2320B)
- Microbial Community (QuantArray-Chlor)
- Dissolved ortho-phosphate (Standard Method 4500 PE and EPA Method 9056A)
- EDB CSIA (Kuder et al, 2012)
- $\delta^2\text{H}$ (Hydrogen/ H_2O Equilibration Isotope Ratio Mass Spectrometry)
- Fluorescein Dye Tracer (Spectrofluorophotometry)

Due to ultimate replacement of the Geotech bladder pumps with the QED MicroPurge® Model P1101HM bladder pumps in September 2017, baseline samples were recollected from September 18 through 26,

2017. Baseline samples were not originally collected at KAFB-106MW1-S in June 2017 due to repeated pump failures. Analytical results from baseline samples are discussed in Section 4.0. Table 4 presents the suite of analytes that were measured by the analytical laboratories and the sampling frequency for the remaining phases of the pilot test.

3.9 Sample Documentation

Sample collection logs, purge logs, and chain-of-custody form were completed by field personnel during monitoring and sampling activities. Sample collection logs and purge logs are included in Appendix H. Chain-of-custody forms are included with the laboratory reports (Appendix I-3).

3.10 Quality Control

Field quality control samples were collected as part of each sampling event and included field duplicate and trip blank samples. Duplicate samples were analyzed to estimate the overall reproducibility of the sampling and analysis process and were collected immediately after the original/parent sample to reduce variability. Trip blank samples were used to evaluate potential contamination by VOCs during sampling, shipment, and laboratory processing. Additionally, internal laboratory quality control samples, including laboratory control samples, replicates, matrix spikes, matrix spike duplicates, and surrogate spike samples were analyzed concurrently with the groundwater samples.

The groundwater analytical data were validated for precision, bias, accuracy, representativeness, comparability, and completeness, and appropriate data qualifiers were appended to the analytical data in the project database. The data validation results are presented in the Data Quality Evaluation Reports, which are included as Appendix I-1 (June 2017 through January 2019 data) and Appendix I-2 (March 2020 through October 2020 data). Laboratory data packages are also provided in Appendix I-3.

3.11 Waste Management

IDW generated during the pilot test included soil generated from drilling activities; liquid IDW generated during drilling operations, well development, equipment decontamination, and groundwater sampling; solid and liquid IDW generated during NAPL removal activities at the extraction wells. All IDW generated during implementation of the pilot test was handled and disposed of in accordance with the Waste Management Plan of the Groundwater Investigation Work Plan (Kirtland AFB, 2011b) and the Work Plan (Kirtland AFB, 2016a). Kirtland AFB Landfill disposal letters and approvals; waste profiles; and hazardous and non-hazardous waste manifests for liquid IDW are provided in Appendix J.

3.11.1 Soil IDW

Soil IDW was generated during drilling and well installation activities at two nested monitoring wells, two extraction wells, and one injection well. All drill cuttings were containerized in plastic-lined, steel roll-off containers pending laboratory analysis for waste characterization and disposal. The field geologist collected soil cuttings from each 5 to 10-foot interval during drilling activities, which represented a composite of the depth interval contained within the specific roll-off container. The cuttings were stored in sealable gallon-sized bags which were labelled with the associated depth interval and roll-off. The sealable bags were stored on ice in a cooler until they were sampled for waste characterization to provide protection from loss of volatiles, despite the roll-off being exposed during the same time period. A sample was collected from each sealable gallon-sized bag (representing soil contained in a specific roll-off) without homogenization for waste characterization. IDW soil samples collected for VOC analysis were collected in jars, filled with no headspace. Approximately 16 ounces were collected per composite sample. Once the analytical results were received, reviewed, and determined to meet landfill requirements, a "Request for Disposal" letter was provided to Kirtland AFB for approval to dispose of the contents of each container. Analytical results for all roll-off containers confirmed that the drill cuttings were not a hazardous waste, and they met the requirement for disposal at the Kirtland AFB Construction

and Demolition Landfill. Soil IDW disposal letters generated for the roll-off containers and associated approval letters are provided in Appendix J-1.

On January 25, 2017 at 12:30 p.m. approximately ¼ to ½ cubic yards of semi-saturated soil was released to the ground surface within the pilot test construction area while attempting to move a roll-off bin. The spill was reported by Kirtland AFB both verbally and in written format to the NMED Hazardous Waste Bureau within twenty-four hours. A Corrective Action Report was submitted to both the NMED Hazardous Waste Bureau and Ground Water Quality Bureau on February 9, 2017 (Kirtland AFB, 2017b) and is included in Appendix J-2.

3.11.2 Liquid IDW – Development and Decontamination

Liquid IDW was generated during decontamination resulting from drilling activities, and during development. The following steps were followed during IDW liquid handling, storage, and characterization for liquid IDW generated during drilling and well development activities:

1. Development and decontamination water were transferred into appropriately sized storage tanks located at the drill site for temporary accumulation, pending laboratory analysis.
 - a. For monitoring wells, liquid IDW generated from development activities was typically accumulated in 275 gallons totes. During development of the pilot test monitoring wells, an average of two totes were filled per well. Water from different wells was not combined.
 - b. For extraction and injection wells, liquid IDW was accumulated in 19,000-gallon Baker tanks, since the development procedures for these tanks are more intensive and produced a greater amount of water. During development of the extraction and injection wells, one Baker tank was filled for each extraction well, and two Baker tanks were filled for the

injection well. Jetting was performed at the injection well as part of the development process and the procedure created a greater volume of liquid IDW.

2. Storage tank and totes were labeled with pending analysis stickers containing the dates of accumulation, well identification, and generator point of contact information.
3. Once development of a specific well was complete, a composite water sample was collected from the storage container(s) using a disposable bailer and analyzed for the following: anions (EPA Method 300), nitrate (EPA Method 353.2), dissolved metals (EPA Method 6010), total lead (EPA Method 6010), semivolatile organic compounds (EPA Method 8270), VOCs (EPA Method 8260), and EDB (EPA Method 8011).
4. Liquid IDW containerized in totes (from monitoring well development) that was determined to be hazardous was transferred into 55-gallon drums and moved to the less than 90-day accumulation area. Hazardous waste labels were affixed to the drums showing generator information, accumulation dates, waste numbers, and the Kirtland EPA identification number. Drums were stored on appropriately sized secondary containment.

Non-hazardous liquid IDW generated from development and decontamination activities was disposed of by Chemical Transportation, Inc. and Clean Harbors at their respective facility located in Albuquerque, New Mexico. Non-hazardous waste manifests are included in Appendix J-3. Hazardous liquid IDW generated from development and decontamination activities was disposed of by Chemical Transportation, Inc. and Clean Harbors at Clean Harbors Deer Trail, LLC in Colorado. Hazardous waste manifests are included in Appendix J-4.

3.11.3 Liquid IDW – Purge Water

Analytical data from groundwater sampling was incorporated with the data collected during liquid IDW sampling of the development/decontamination water to generate both hazardous and non-hazardous waste

profiles for disposal of purge water (Appendix J-5). The highest concentrations observed in IDW and groundwater samples were used to generate the waste profiles, thus eliminating the need to frequently sample liquid IDW generated during sampling activities. Hazardous purge water was transferred into 55-gallon, open-top metal drums placed on secondary containment pads located within the less than 90-day accumulation area. Non-hazardous purge water was placed in a single 275-gallon tote.

Hazardous liquid IDW generated from groundwater sampling activities conducted prior to 2020 was disposed of by Chemical Transportation, Inc. and Clean Harbors at Clean Harbors Aragonite, LLC in Grantsville, Utah and by Advanced Chemical Transportation at their local facility. The non-hazardous liquid IDW generated from groundwater sampling activities conducted prior to 2020 was disposed of by Advanced Chemical Transportation at their local facility on March 19, 2019. Hazardous liquid IDW generated from groundwater sampling activities conducted from March through October 2020 was disposed of by ACTenviro (formerly Advanced Chemical Transportation) at their Albuquerque facility.

3.11.4 NAPL IDW

Liquid IDW consisting of groundwater and NAPL bailed from extraction wells KAFB-106EX1 and KAFB-106EX2 in June/July 2020 was transferred into two 55-gallon, open-top metal drums placed on secondary containment pads located within the less than 90-day accumulation area. A new profile was generated for the waste consisting of NAPL comingled with groundwater (Appendix J-5) and the waste was removed by ACTenviro on September 29, 2020. The hazardous waste manifest is included in Appendix J-4.

The absorbent socks used to remove residual NAPL remaining in the extraction wells were contained within a U.S. Department of Transportation-approved 5-gallon pail on a secondary containment pad located within the less than 90-day accumulation area. The absorbent sock waste was removed on

December 26, 2020 by ACTenviro under a new profile (Appendix J-5). The hazardous waste manifest is included in Appendix J-4.

4. PILOT TEST RESULTS

This section describes the analytical results associated with the pilot test. Analytical data tables for each well are included as Tables 7 through 15.

4.1 Baseline Conditions

All pilot test wells were sampled prior to Phase 1 recirculation activities to establish pre-test baseline conditions, including measures of various tracers used, microbial community, geochemistry, contaminants (e.g., benzene and EDB), EDB degradation products (e.g., ethene, ethane, bromide), and EDB CSIA. As noted in Section 3.2, NAPL was observed at KAFB-106MW1-S during this period, and a sample of the NAPL was collected for analysis.

The pilot test was sited near existing well KAFB-106064, which contained EDB at concentrations of 17 µg/L (Second Quarter 2016; Kirtland AFB, 2016c) and 9.3 µg/L (Fourth Quarter 2016; Kirtland AFB, 2017c) and benzene at concentrations of 1,100 µg/L (Second Quarter 2016) and 1,000 µg/L (Fourth Quarter 2016) prior to installation of the new pilot test wells. After installation and development of the new pilot test wells, EDB and benzene concentrations of baseline groundwater samples at KAFB-106064 were measured at 143 µg/L and 4,730 µg/L, respectively. These increases at KAFB-106064 may have been the result of different types of sample pumps (bladder pumps) placed at different depths, heterogenous distribution of EDB and benzene in the subsurface, or perhaps due to increased mass transfer from residual NAPL during well installation and development. Higher concentrations were also observed at the other newly installed wells, where EDB ranged from 20.1 µg/L (KAFB-106IN1) to 432 µg/L (KAFB-106MW1-S) and benzene ranged from 586 µg/L (KAFB-106MW2-S) to 7,320 µg/L (KAFB-106MW1-S). The highest EDB and benzene concentrations observed were at KAFB-106MW1-S where NAPL was previously observed and collected (September 2017). EDB concentrations from

baseline sampling and during the most recent sampling during the pilot test (Phase 4) are presented in Figure 8.

As will be further described below, representative microorganisms likely capable of EDB debromination were present in large numbers at shallow wells during the baseline evaluation, together with a reducing environment favorable for reductive debromination. Elevated concentrations of the EDB degradation products ethene, ethene, and bromide, together with more positive EDB $\delta^{13}\text{C}$ values (up to -5‰) at wells during the baseline evaluation, indicated that EDB degradation was likely ongoing or had previously occurred at the pilot test location. In a phased approach, the pilot test evaluated whether EDB degradation could be enhanced through addition of biostimulation amendments.

4.2 Amendment Distribution

Various tracers were amended to the recirculated groundwater to evaluate and verify the distribution and transport times between wells during the pilot test. These tracers included fluorescein dye (Phase 1), deuterium labeled water ($^2\text{H}_2\text{O}$, Phase 1), and iodide (Phase 2). Fluorescein is a fluorescent tracer often used in studies of groundwater flow in karst systems, $^2\text{H}_2\text{O}$ occurs as approximately 0.03% of water, and iodide is perhaps best known as an additive in iodized table salt, albeit at low concentrations. In addition to these tracers, biostimulation amendments added to the groundwater included a fermentable sodium lactate-based substrate with nutrients (WilClear Plus®) and DAP.

4.2.1 Tracer Distribution During Phase 1

Fluorescein was added together with deuterated water over a period of 24 hours while the recirculation system operated at 20 gpm (10 gpm at KAFB-106EX1, and 10 gpm at KAFB-106EX2). Three measurements of fluorescein concentrations of injected water collected directly from the KAFB-106IN1 sample port averaged 570 $\mu\text{g/L}$ during the 24 hours of tracer injection, while background concentrations were non-detectable.

Figures 9 and 10 show measured fluorescein concentrations in samples collected from shallow and intermediate wells, respectively. The average transport times for the anaerobic shallow wells with high EDB concentrations, as indicated by the date of maximum tracer contribution, were of primary interest and are provided in Table 16. These indicate that transport times increased with increasing distance, and no strong indications of preferential flow were apparent. Decreases in maximum concentrations with increasing distances from the injection well were indicative of dispersion within the subsurface as expected. After the 30 days of groundwater recirculation and fluorescein distribution, fluorescein concentrations among the shallow wells of the pilot test ranged from 3.7 $\mu\text{g/L}$ (KAFB-106EX1) to 8.2 $\mu\text{g/L}$ (KAFB-106EX2). After an additional month without groundwater recirculation (passive portion of Phase 1), fluorescein concentrations in the groundwater ranged from 4.1 $\mu\text{g/L}$ (KAFB-106MW1-S) to 5.5 $\mu\text{g/L}$ (KAFB-106064) among the shallow wells. Among the intermediate monitoring wells, fluorescein was observed at a maximum of 92 $\mu\text{g/L}$ at KAFB-106MW2-I after 7 days of recirculation, and at a maximum of 50 $\mu\text{g/L}$ at KAFB-106MW1-I after 30 days of recirculation. No fluorescein was observed at the existing intermediate monitoring well KAFB-106063 during Phase 1.

Deuterium labeled water was added at the same time as the fluorescein to ensure that at least one tracer was measurable during the tracer test. Three measurements of $\delta^2\text{H}$ values of the injected water averaged +590‰ during the 24 hours of tracer injection, while background $\delta^2\text{H}$ values at the test area ranged from -97‰ to -92‰. Figures 11 and 12 show measured $\delta^2\text{H}$ values of the water samples collected from shallow and intermediate wells. There is clear agreement between the fluorescein and $\delta^2\text{H}$ data, which provides confidence in observed transport times and water distribution. After the 30 days of groundwater recirculation, the deuterated water was redistributed in the groundwater and $\delta^2\text{H}$ values among the shallow wells of the pilot test ranged from -90‰ (KAFB-106EX1) to -84‰ (KAFB-106EX2). After an additional month without groundwater recirculation (passive portion of Phase 1), $\delta^2\text{H}$ values in the groundwater ranged from -89‰ (KAFB-106MW1-S) to -86‰ (KAFB-106MW2-S) among the shallow wells. Among the intermediate monitoring wells, $\delta^2\text{H}$ was observed at a maximum of +19‰ at KAFB-

106MW2-I after 7 days of recirculation, and at a maximum of -62‰ at KAFB-106MW1-I after 30 days of recirculation. For reference, Vienna Standard Mean Ocean Water has a $\delta^2\text{H}$ value of 0‰, by definition. As with fluorescein, no significant shift in $\delta^2\text{H}$ values was observed at the existing intermediate monitoring well KAFB-106063 during Phase 1.

The results from the Phase 1 tracer test indicated that the targeted treatment zone encompassing the shallow groundwater monitoring wells were hydraulically connected with the injection well. Additionally, it was evident that amendments were distributed in the treatment zone under the planned operating conditions. In particular, distribution of amendments to groundwater sampled by monitoring wells nearest to the injection well (KAFB-106MW2-S and KAFB-106064) occurred within 5 days of operation, suggesting a high likelihood of successfully distributing biostimulation amendments that favor reductive debromination of EDB. Based on these observations during Phase 1 operations, the recirculation system was operated similarly to distribute biostimulation amendments during Phases 2 and 3.

4.2.2 Tracer Distribution During Phase 2, 3, and 4

Phase 2

Iodide, introduced as KI, was used as conservative tracer to verify distribution of water containing biostimulation amendments, and to allow for distinction between recirculated waters and background water. During the Phase 2 recirculation period, four samples of the injected groundwater were collected directly from the KAFB-106IN1 sample port while the chemical feed pump was operating. Iodide results from the injectate ranged from 18 to 26 mg/L. Adjusting for the timing of amendment cycles, the average concentration of iodide in reinjected water ranged from 15 to 18.6 mg/L.

Figures 13 and 14 show iodide concentrations of samples collected from shallow and intermediate wells, respectively, during the pilot test. The iodide data are consistent with observations made using other tracers during Phase 1, showing more rapid transport to the shallow monitoring wells nearest to the

injection well (KAFB-106MW2-S and KAFB-106064), with amendments arriving at the more distant extraction wells last. Also evident in the iodide data is that final concentrations observed at the nearest monitoring wells of 17 mg/L (KAFB-106MW2-S) and 18 mg/L (KAFB-106064) are equivalent with injected iodide concentrations (KAFB-106IN), which indicates that most of the groundwater observed at these wells was previously amended and reinjected. Groundwater at the more distant shallow groundwater monitoring well (KAFB-106MW1-S) was measured at 11 mg/L during the recirculation period, slightly lower than injected concentrations, indicating that a fraction of that water represented background conditions, or water that had previously been recirculated (during Phase 1) without iodide amendments. Lower concentrations of iodide observed at the extraction wells, 2.7 mg/L at KAFB-106EX2 and 1.3 mg/L at KAFB-106EX1, indicate longer transport times and dispersion consistent with Phase 1 results, and dilution due to extraction of water from both inside and outside the treatment zone. Consistent with Phase 1 tracer study results, elevated iodide concentrations up to 7.3 mg/L were observed at the nearest intermediate monitoring well (KAFB-106MW2-I), while transport to the other intermediate monitoring wells were slower, with an iodide measurement of 1.2 mg/L at KAFB-106MW1-I and no detections of iodide at KAFB-106063. Overall, iodide concentrations observed during the Phase 2 recirculation period indicated good distribution of injected waters, particularly within the treatment zone encompassing the shallow monitoring wells nearest to the injection well.

After recirculation of amendments at the start of Phase 2, a passive period without recirculation, but with continued monitoring, commenced and lasted more than four months and included four sampling events. Changes in iodide concentrations during the Phase 2 passive period were also informative. Iodide concentrations among the shallow groundwater monitoring wells nearest the injection well were fairly constant, with concentrations ranging from 17 to 22 mg/L for wells KAFB-106064 and KAFB-106MW2-S, and concentrations ranging from 13 to 16 mg/L for KAFB-106MW1-S. These iodide concentrations indicated that the sampled groundwater remained heavily influenced by treatment activities. Interestingly, iodide concentrations at KAFB-106EX1 increased from 1.3 mg/L at the end of

recirculation to 8.3 mg/L during the Phase 2 passive period, and iodide concentrations at KAFB-106EX2 decreased from 2.7 mg/L at the end of recirculation to 0.3 mg/L during the Phase 2 passive period. While a decrease in iodide concentrations can result from iodide oxidation to iodate, the reducing conditions present at the site suggest this process should be limited. Rather the shifts in iodide concentrations at the outer boundaries of the treatment zone provide evidence that groundwater from outside the treatment zone is entering the treatment zone at KAFB-106EX2, and that groundwater with higher iodide concentrations from within the treatment zone are continuing to flow toward KAFB-106EX1. These data are consistent with a general west to east groundwater flow at the pilot site under ambient conditions at the time of the pilot test. A similar decrease in iodide concentrations was also observed at the intermediate monitoring well KAFB-106MW2-I, indicating that this well may also be located close to the upgradient edge of the treatment zone and influenced by groundwater from outside the treatment zone during passive periods.

Phase 3

During Phase 3 amendment and recirculation activities, no additional iodide was added to the aquifer as KI; however, iodide already present in the subsurface after Phase 2 was redistributed. As such, the presence of iodide still served as a conservative tracer to allow for distinction between recirculated waters (from either Phase 2 or 3) and background groundwater with low iodide concentrations. At the end of the Phase 3 recirculation period, iodide concentrations among the shallow groundwater monitoring wells ranged from 4.5 mg/L (KAFB-106MW2-S) to 6.2 mg/L (KAFB-106MW1-S). This tight range indicates that amendments continued to be distributed well in the treatment zone during Phase 3. Interestingly, iodide concentrations of the intermediate monitoring wells increased during Phase 3 recirculation, with concentrations increasing to 15 mg/L (KAFB-106MW1-I), 10 mg/L (KAFB-106MW2-I), and 5.2 mg/L (KAFB-106063). While some redistribution of iodide was apparent during Phase 2 passive periods, these increases in iodide concentrations at the intermediate monitoring wells indicate that transport to these locations generally took longer than the period of active recirculation with iodide amendments during

Phase 2 and continued to be redistributed to deeper locations during Phase 3 recirculation activities. This is logical considering the shallower screen intervals of both the injection well and extraction wells.

As during Phase 2, a passive period without recirculation, but with continued monitoring, commenced after recirculation ended. Iodide concentrations among the shallow groundwater monitoring wells nearest to the injection well varied little, with concentrations ranging from 6.3 mg/L (KAFB-106MW1-S) to 3.6 mg/L (KAFB-106MW2-S). These concentrations of iodide during the passive period indicated that the sampled groundwater remained heavily influenced by treatment activities. As before, iodide concentrations at KAFB-106EX1 increased from 4.6 mg/L at the end of recirculation to 6.2 mg/L during the Phase 3 passive period, and iodide concentrations at KAFB-106EX2 decreased from 4.6 mg/L at the end of recirculation to 0.5 mg/L during the Phase 3 passive period. These data remain consistent with a general west to east groundwater flow at the pilot site under ambient conditions. As during Phase 2, a similar decrease in iodide concentrations was also observed at the intermediate monitoring well KAFB-106MW2-I, again indicating that this well may be located close to the upgradient edge of the treatment zone and influenced by groundwater from outside the treatment zone during passive periods.

Phase 4

As described previously, Phase 4 of the pilot test did not include any groundwater recirculation efforts, or introduction of additional amendments to the subsurface. The presence of iodide served as a conservative tracer of groundwater that had previously been amended and recirculated. During Phase 4, iodide concentrations among the shallow monitoring wells ranged from 3.8 mg/L (KAFB-106064) to 6.3 mg/L (KAFB-106MW2-S); iodide concentrations at KAFB-106EX1 ranged from 6.8 mg/L (August 2020) to 10 mg/L (March 2020); iodide concentrations at KAFB-106EX2 ranged from non-detections to 0.35 (October 2020); and iodide concentrations at the injection well (KAFB-106IN1) ranged from 2.6 mg/L (October 2020) to 5.1 mg/L (August 2020). Detectable concentrations of iodide among the intermediate

groundwater monitoring wells ranged from 0.35 mg/L (KAFB-106MW2-I) to 13 mg/L (KAFB-106MW1-I) during Phase 4.

Iodide concentrations observed at shallower wells during Phase 4 passive period were consistent with those observed during Phase 3. This consistency indicates limited groundwater flux across the pilot test location over the approximately two-year period that passed since water was last recirculated. The sampled groundwater remained heavily influenced by treatment activities. During Phase 4, iodide concentrations at intermediate depth groundwater monitoring wells were more variable and a decrease in iodide concentrations was evident in at least two (KAFB-106MW1-I and KAFB-106MW2-I) of the three wells (Figure 14). Sulfate and methane concentrations at KAFB-106MW1-I and KAFB-106MW2-I during Phase 4 (see Section 4.4) indicate less reducing conditions at these wells, and the decrease in iodide at these wells may have resulted from possible oxidation of iodide to iodate, or influx of groundwater from outside the treatment zone.

4.2.3 Distribution of Fermentable Substrate

Recirculated groundwater during Phase 2 and Phase 3 was amended with WilClear Plus®, which served as a fermentable substrate to stimulate debrominating organisms in the subsurface during the pilot test. As noted in the discussion of tracers above, reinjected groundwater was distributed throughout the treatment zone of the pilot test. However, due to possible sorption and retardation of organic compounds, the distribution of this fermentable substrate may have been slower than that of the tracers and observations of substrate and its immediate transformation products (e.g., acetate and propionate) provide additional insight regarding substrate distribution. During the Phase 2 recirculation period, three samples of the injected groundwater were collected directly from the KAFB-106IN1 sample port while the chemical feed pump was operating. Lactate concentrations of the injectate ranged from 140 to 154 mg/L. Adjusting for the timing of amendment cycles, the average concentration of lactate in reinjected water was approximately 110 mg/L. While measurements of reinjected substrate concentrations at KAFB-106IN1

were not made during Phase 3 recirculation activities, the system was operated under similar conditions, and lactate concentrations likely averaged between 100 and 150 mg/L as observed during Phase 2 recirculation.

Figures 15, 16, and 17 show measured lactate, acetate, and propionate concentrations of samples collected at all the monitoring wells during the pilot test. All three compounds were observed in baseline samples, perhaps as a result of low-level fermentation of organics present in the aquifer. While lactate was introduced to the subsurface at concentrations between 100 and 150 mg/L, concentrations at monitoring wells never exceeded 4 mg/L. Biological transformation of lactate, however, results in the production of both acetate and propionate. While acetate and propionate were detected in the amended and reinjected groundwater at concentrations of less than 30 mg/L during Phase 2, significantly higher concentrations were observed at monitoring wells, presumably as a result of *in situ* transformation of the amended carbon substrate. All wells showed clear increases in acetate concentrations, ranging from a lowest maximum of 44 mg/L in KAFB-106EX2 to a highest maximum of 151 mg/L in KAFB-106MW2-S. Likewise, propionate concentrations increased after biostimulation amendments, with only KAFB-106063 having no detections. Propionate concentrations in the wells ranged from a lowest maximum of 6.8 mg/L in KAFB-106MW1-I to a highest maximum of 74.9 mg/L in KAFB-106064. The observed decrease in lactate concentrations, together with increases in acetate and propionate suggest that lactate fermentative conditions conducive to reductive debromination of EDB were present at most wells during the pilot test. As expected, concentrations of acetate and propionate decreased at many of the wells during passive periods.

4.3 Microbial Analysis

As described in Section 4.2.3, amendments were supplied in the treatment area during Phase 2 and 3 to stimulate biological activity capable of reductive debromination of EDB. Figures 18 to 24 show populations of total eubacteria (EBAC), sulfate reducing bacteria (APS), methanogens (MGN),

Dehalobacter spp. (DHBt), *Dehalobacter* DCM (DCM), *Dehalogenimonas* spp. (DHG), and *Desulfitobacterium* spp. (DSB) as determined by Microbial Insights' QuantArray-Chlor assay analysis. Generally, the results indicated that the groundwater contained large populations of microorganisms prior to pilot test activities, with EBAC counts ranging from around 10^6 cells per milliliter (cells/mL) to 10^7 cells/mL, APS counts ranging from 10^4 cells/mL to 10^5 cells/mL, and representative organisms likely capable of EDB debromination (i.e., DHBt and DSB) ranging from around 10^4 to 10^5 cells/mL in baseline samples. This is consistent with microbial analyses from at KAFB-106064 in 2015 and an order of magnitude (OOM) or greater than observed at a background well in 2015 (Kirtland AFB, 2016b). Given the large release of hydrocarbons at the site that can provide energy for diverse microbial communities, this high level of activity is not surprising. With one exception during Phase 4 (KAFB-106IN1), populations of *Dehalococcoides* spp. (DHC), a well-known dehalogenating species, were below 30 cells/mL throughout the pilot test and these DHC populations were not expected to contribute to EDB degradation during the pilot test without bioaugmentation. Fortunately, for the pilot test, the high number of other likely debrominating organisms suggested that biostimulation to increase their activity was possible.

During the various phases of the pilot test, the measured populations increased by as much as two OOM depending on the organism and monitoring well examined. Increased microbial populations were particularly apparent at the deeper wells (i.e., KAFB-106063, KAFB-106MW1-I and KAFB-106MW2-I), likely because conditions at these locations were more oligotrophic prior to recirculation. For populations of EBAC, much of the observed increase in population size occurred during Phase 1 recirculation activities. As with the deeper wells, this increase in EBAC after Phase 1 recirculation activity may be the result of organic carbon and nutrient redistribution in the treatment zone along with the increased groundwater flows due to recirculation. As with the high cell numbers prior to recirculation and amendments at the site, the large numbers of organisms likely capable of reductive debromination (10^5 to 10^6 cells/mL for DHBt, and around 10^5 cells/mL for DSB) observed after biostimulation indicated that the

microbial capacity for EDB debromination remained very prevalent during the pilot test. Unfortunately, the microbial analyses performed do not provide direct information regarding the biodegradation activity of the microbial community. Such activity must be inferred from other lines of evidence collected during the pilot test, such as changes in EDB concentrations, products of EDB degradation, and shifts in isotope composition of residual EDB.

Three microbial populations that increased by more than 2 OOM during pilot test activities are MGN, DHG, and DCM. Stimulation of methanogens was also evident from increases in methane within the treatment zone, as discussed below in Section 4.4. The increases in DHG and DCM occurred only after the addition of biostimulation amendments, but it is unclear whether these directly impacted EDB degradation. DHG are known to reductively dehalogenate 1,2-dichloroethane (Moe et al., 2009), the chlorinated analog of EDB, and DHG likely also dehalogenate EDB. DCM are particularly known for their ability to grow using dichloromethane (Justicia-Leon et al., 2012), but are also a species of Dehalobacter (DHBt) that may include the ability to reductively dehalogenate other compounds. The growth of DHG and DCM suggest that EDB debromination activity may have been stimulated during the study, but, as with the other microbial data, these data are not conclusive in isolation.

4.4 Geochemistry

DO, sulfate, iron, and methane were monitored during the pilot test as indicators of *in situ* redox conditions (Figures 25 to 28). DO was monitored during purging activities using a water quality meter (YSI™ ProDSS). Samples for sulfate, iron, and methane were collected from pilot test wells and submitted for laboratory analysis. All four parameters indicate that intended anaerobic conditions favoring reductive debromination of EDB occurred during the pilot test.

The pilot test was sited within a zone significantly impacted by hydrocarbons. DO concentrations at the shallow wells most impacted were low (less than 1 mg/L) under baseline conditions presumably due to

past aerobic degradation of some of these hydrocarbons. Intermediate wells were not as impacted by hydrocarbons and generally had greater DO concentrations ranging from 1.7 mg/L at KAFB-106MW2-I to 7.4 mg/L at KAFB-106MW1-I. During Phase 1 recirculation without biostimulation amendments, DO decreased to less than 0.5 mg/L in the wells, except for extraction well KAFB-106EX1 (2.1 mg/L) and intermediate wells KAFB-106MW1-I (8.4 mg/L) and 106063 (1.9 mg/L). Extraction well KAFB-106EX1 is located near the eastern edge of the hydrocarbon and EDB plume and pumping may have drawn in more oxygen rich and less impacted groundwater from greater depths or from further east. As indicated by tracer tests, intermediate wells KAFB-106MW1-I and KAFB-106063 were less impacted by recirculated water during the Phase 1 recirculation period. During and after Phase 2 and Phase 3 recirculation periods in which amendments were introduced to groundwater, DO concentrations were below 1 mg/L at all wells, with most concentrations below 0.5 mg/L. Occasional DO concentrations above 1 mg/L were observed at the extraction wells KAFB-106EX1 and KAFB-106EX2 during passive periods. The extraction well samples were collected by briefly turning on the recirculation pumps and the slightly elevated DO concentrations may have resulted from minor introductions of oxygen during this sampling process, or it may have resulted from collection of more oxygenated waters occurring *in situ*. During Phase 4, DO concentrations remained below 1 mg/L except at extraction wells KAFB-106EX1 and KAFB-106EX2 during the final sampling event (October 2020). The elevated DO at the two extraction wells is unexplained and other parameters and analytes at these wells generally appear consistent with previous observations. Overall, the low DO concentrations within the treatment zone reflect favorable conditions for reductive debromination of EDB.

With the exception of KAFB-106EX2 (25 mg/L), sulfate concentrations in shallow wells were low (<5 mg/L) under baseline conditions presumably due to past sulfate reduction to sulfide. Sulfate reduction is indicative of bulk reducing conditions in the aquifer that favor EDB debromination and, under site conditions, the resulting sulfide might interact with other subsurface elements (e.g., iron) to form sulfide minerals. Prior to Phase 4 of the pilot test, sulfate concentrations at KAFB-106EX2 always exceeded

10 mg/L with a maximum concentration of 39.7 mg/L (Phase 2 passive), perhaps as a result of extracting groundwater richer in sulfate from outside the treatment zone. Intermediate wells were not as impacted by hydrocarbons and generally had greater sulfate concentrations under baseline conditions ranging from 16.4 mg/L at KAFB-106063 to 23.8 mg/L at KAFB-106MW1-I. During Phase 1 recirculation without biostimulation amendments, there was an increase in sulfate concentrations among the shallow wells as sulfate was redistributed at the site with concentrations ranging from 13.8 mg/L at KAFB-106064 to 28.5 mg/L at KAFB-106EX1, and among the intermediate wells with concentrations ranging from 15.4 mg/L at KAFB-106MW2-I to 26 mg/L at KAFB-106063. During the subsequent Phase 1 passive period, sulfate generally decreased in the wells to less than 5 mg/L due to sulfate reduction, but concentrations exceeding 10 mg/L were still observed at the extraction wells and two of the three intermediate wells (KAFB-106063 and KAFB-106MW1-I). During and after Phase 2 and Phase 3 recirculation periods, sulfate concentrations were below 5 mg/L in the wells (except for KAFB-106EX2) and were often not detected. During the recirculation events themselves, both extraction wells had sulfate concentrations exceeding 5 mg/L, and it is likely that much of this observed sulfate was drawn to the extraction wells from outside the treatment zone. During Phase 4, after observation of NAPL in KAFB-106EX2 and KAFB-106EX1, its subsequent removal, and installation of new sampling pumps, lower sulfate concentrations of less than 1 mg/L were noted in KAFB-106EX2, consistent with more reducing conditions observed at other locations. During Phase 4, sulfate concentrations at intermediate wells KAFB-106MW1-I and KAFB-106MW2-I increased to more than 5 mg/L, perhaps indicating somewhat more oxidized conditions. Overall, the low sulfate concentrations (below 20 mg/L), and observed decreases in sulfate concentrations within the treatment zone reflected reducing conditions favorable for reductive debromination of EDB.

Due to the low solubility of ferric (Fe(III)) iron under circumneutral conditions as found at the site, dissolved iron concentrations are often considered indicative of more reduced ferrous (Fe(II)) iron. Minerals containing oxidized Fe(III) are fairly ubiquitous and elevated dissolved iron concentrations are usually indicative of iron reducing environments. Baseline measurements at the site indicated dissolved

iron concentrations ranging from 1 mg/L (KAFB-106MW1-S) to 12 mg/L (KAFB-106MW2-S) in shallow wells, but concentrations at deeper, less impacted wells were all less than 1 mg/L. During and after Phase 2 and Phase 3 recirculation periods, dissolved iron concentrations increased due to iron reduction and maximum concentrations at individual wells ranged from 4.2 mg/L in KAFB-106EX2 to 22.1 mg/L in KAFB-106MW2-I. During Phase 4, dissolved iron concentrations ranged from 0.885 mg/L in KAFB-106MW2-I to 15.2 mg/L in KAFB-106MW2-S. Generally, the elevated dissolved iron concentrations observed during the pilot test are consistent with bulk reducing conditions that facilitate reductive debromination of EDB.

High methane concentrations in the subsurface are frequently indicative of methanogenesis that occurs under anaerobic conditions. Methane was observed during baseline measurements among shallow wells with concentrations ranging from 2 µg/L at KAFB-106MW1-S to 179 µg/L at KAFB-106064. The higher concentrations support the interpretation that the treatment zone was anaerobic prior to pilot test activities. During the Phase 1 recirculation period, methane concentrations dropped to less than 10 µg/L suggesting mixing from less methanogenic regions, increased abiotic losses (e.g., due to degassing under flow conditions), or methane oxidation. During the Phase 1 passive period, methane concentrations rebounded with a maximum concentration of 350 µg/L at KAFB-106MW2-S. During the Phase 2 recirculation period when lactate amendments were introduced, methane concentrations generally fell again, but increased by many OOM at several wells during the following passive period, with concentrations exceeding 10,000 µg/L at the injection well and KAFB-106MW2-S. After the Phase 3 recirculation period where lactate amendments were introduced, methane concentrations increased further and all wells, except for KAFB-106MW1-I, exceeded 100 µg/L. Shallow wells KAFB-106MW2-S and KAFB-106064 exceeded 10,000 µg/L. During Phase 4, while elevated methane concentrations were noted throughout the pilot test area, the lowest methane concentrations were observed at KAFB-106MW1-I and KAFB-106MW2-I, and may indicate somewhat more oxidized conditions at these locations. Methane concentrations measured during Phase 4 were above 100 µg/L in all wells except KAFB-106MW1-I and

KAFB-106MW2-I; and exceeded 10,000 $\mu\text{g/L}$ in shallow monitoring wells KAFB-106MW2-S and KAFB-106064. It should be noted that the aqueous solubility of methane at 1 atmosphere is in the range of 20,000 $\mu\text{g/L}$, so it is feasible that minor pockets of gas-phase methane existed near wells with highest methane concentrations. These elevated methane concentrations are consistent with the increased populations of methanogens discussed in Section 4.3 and are indicative of reducing conditions favorable for EDB debromination.

4.5 Selected Contaminants of Interest

The primary objective of this pilot test was to evaluate the potential for enhanced anaerobic EDB biodegradation. Degradation of other contaminants co-located with EDB due to the nature of their common sources, including benzene and toluene, was not the objective of this pilot test. However, benzene and toluene were used to help evaluate the fate of EDB. Both benzene and toluene are slightly less water soluble and more volatile than EDB, and their behavior helps constrain expectations for some abiotic EDB loss mechanisms, such as volatilization. Additionally, benzene and toluene are generally less susceptible than EDB to degradation under anaerobic conditions. As such, it is helpful to discuss the behaviors of benzene and toluene prior to discussing EDB degradation observed during the pilot test. Figures 29 to 31 show concentrations of benzene, toluene, and EDB, respectively for all wells of the pilot test, and Table 17 shows the reduction of benzene, toluene, and EDB associated with each Phase of the pilot test, as well as from baseline evaluation to the most recent Phase 4 sampling.

4.5.1 Benzene and Toluene

Benzene concentrations in shallow monitoring wells during the baseline evaluation ranged from 586 $\mu\text{g/L}$ at KAFB-106MW2-S to 8,240 $\mu\text{g/L}$ at KAFB-106MW1-S; benzene was not detected in the intermediate wells during baseline measurements. The measured benzene baseline concentrations were somewhat higher than those measured prior to pilot test well installation and development activities (benzene concentrations were approximately 1,000 $\mu\text{g/L}$ at well KAFB-106064). This increase may have been the

result of different types of sample pumps (bladder pumps) placed at different depths, heterogenous distribution of benzene in the subsurface, or perhaps due to increased mass transfer from residual NAPL during well installation and development. It should be noted that the highest benzene concentration was observed at KAFB-106MW1-S where NAPL was present at the start of the pilot test (September 2017). During the Phase 1 recirculation period, benzene concentrations at shallow monitoring wells were more evenly distributed throughout the site and ranged from 2,730 µg/L (KAFB-106MW2-S) to 3,630 µg/L (KAFB-106MW1-S). With the exception of the injection well (KAFB-106IN1) and monitoring well KAFB-106MW1-S, benzene concentrations in shallow monitoring wells for the remainder of the pilot test ranged in concentration from 1,500 µg/L at KAFB-106MW2-S to 6,700 µg/L at KAFB-106EX2, indicating limited losses due to biodegradation or abiotic mechanisms (e.g., volatilization, dilution). Benzene concentrations as low as 590 µg/L were observed at the injection well during Phase 4 sampling. Interestingly, benzene increased during the passive periods at the shallow well KAFB-106MW1-S to concentrations as high as 9,800 µg/L. The higher concentration at KAFB-106MW1-S is similar to baseline conditions prior to recirculation and may be the result of increased mass transfer from residual NAPL phases, as NAPL had previous been observed at that location.

Relative to the shallower monitoring wells, benzene concentrations at the intermediate wells during the pilot test were more variable and interpreting changes in these benzene concentrations is more challenging. As noted earlier, benzene was not detected at the intermediate wells during baseline measurements, but benzene concentrations increased after recirculation activities mixed groundwater over a greater depth. During Phase 2 and Phase 3 recirculation periods, benzene concentrations ranged from 1,200 µg/L to 3,600 µg/L at the intermediate wells. However, these benzene concentrations decreased to approximately 50 µg/L during the Phase 2 passive period at KAFB-106MW1-I and 106MW2-I; and to 0.67 µg/L at KAFB-106MW2-I by the end of Phase 4 passive monitoring. No significant decrease in benzene concentrations was noted at KAFB-106063. The observed decreases in benzene concentrations may be due to sorption in the soils or degradation, but may also be attributed in part to the influx of

groundwater not impacted by benzene as decreases in the iodide tracer were also observed in KAFB-106MW2-I.

Toluene concentrations in shallow monitoring wells during the baseline evaluation ranged from 1,540 µg/L at KAFB-106MW2-S to 13,200 µg/L at KAFB-106MW1-S, and toluene concentrations were less than 10 µg/L in all three intermediate monitoring wells, significantly less than the EPA maximum contaminant level (MCL) of 1,000 µg/L (EPA, 2009). As with benzene, the highest toluene concentration was observed at KAFB-106MW1-S where NAPL was present at the start of the pilot test. During the Phase 1 recirculation period, toluene concentrations at shallow monitoring wells were more evenly distributed throughout the site and ranged from 4,740 µg/L (KAFB-106MW2-S) to 9,330 µg/L (KAFB-106MW1-S). Toluene concentrations in the shallow monitoring wells for the remainder of Phases 1 through 3 ranged in concentration from 3,300 µg/L at the injection well to 19,500 µg/L at KAFB-106064, indicating limited losses due to biodegradation or abiotic mechanisms during this time (e.g., volatilization, dilution). Interestingly, toluene concentrations decreased during Phase 4 passive monitoring at many shallow wells (see Figure 30). These decreases were far greater than for benzene and may indicate some anaerobic biodegradation of toluene.

As with benzene, toluene concentrations at the intermediate wells during the pilot test were more variable and interpreting changes in these toluene concentrations is challenging. Toluene impacts at the intermediate wells were limited during the baseline evaluation, but toluene concentrations increased after recirculation activities mixed groundwater over a greater depth. During Phase 2 and Phase 3 recirculation periods, toluene concentrations increased to concentrations as high as 19,000 µg/L at the intermediate wells, but as observed with benzene, toluene concentrations decreased during the following passive periods at wells KAFB-106MW1-I and KAFB-106MW2-I, decreasing to below detectable concentrations at KAFB-106MW2-I during Phase 4 passive monitoring. Toluene concentrations decreased during Phase 4 passive monitoring at KAFB-106063 to a concentration of 1,800 µg/L (from 19,000 µg/L during

Phase 3 passive period). As noted with benzene, the observed decreases in toluene concentrations at the intermediate wells may be due to sorption in the soils or degradation, but may also be attributed in part to the influx of groundwater not impacted by toluene as decreases in iodide tracer were also observed in KAFB-106MW2-I and KAFB-106MW1-I.

Overall, the trends among benzene and toluene concentrations suggest that losses during and after recirculation were limited at the shallower wells, but interpretation of trends at the intermediate wells is more challenging. With the exception of toluene decreases noted among shallow monitoring wells during Phase 4 monitoring, the reasonably constant benzene and toluene concentrations observed in the shallow zone throughout the pilot test provide a good point of comparison to help evaluate EDB degradation. Decreases in EDB concentrations much greater than observed for benzene and toluene provide evidence of EDB degradation, as other abiotic mechanisms leading to lower concentrations would likely be mirrored in benzene and toluene data.

4.5.2 EDB

EDB Concentrations

EDB was the contaminant targeted by these pilot test efforts. EDB concentrations in shallow monitoring wells during the baseline evaluation ranged from 20.1 µg/L at KAFB-106IN1 to 432 µg/L at KAFB-106MW1-S, and among the intermediate wells EDB was only detected at KAFB-106MW2-I with a concentration of approximately 0.1 µg/L. These baseline EDB concentrations were somewhat higher than that measured prior to pilot test well installation, when EDB concentrations at KAFB-106064 were 9.3 µg/L (Fourth Quarter 2016 Kirtland AFB, 2017c) and 17 µg/L (Second Quarter 2016; Kirtland AFB, 2016c). This increase may have been the result of different types of sample pumps (bladder pumps) placed at different depths, heterogenous distribution of EDB in the subsurface, or perhaps due to increased mass transfer from residual NAPL during well installation. As with benzene and toluene, the

highest EDB concentration during the baseline evaluation was observed at KAFB-106MW1-S where NAPL was present at the start of the pilot test.

EDB concentrations at shallow monitoring wells were more evenly distributed during the Phase 1 recirculation period and ranged from 50.4 µg/L (KAFB-106EX1) to 137 µg/L (KAFB-106EX2), with EDB concentrations at wells closer to the injection well ranging from 68 µg/L (KAFB-106MW2-S) to 104 µg/L (KAFB-106MW1-S). Compared to the EDB concentrations observed during Phase 1 recirculation, concentrations at the shallow monitoring wells decreased during the following Phase 1 passive period, with EDB reductions of approximately 75% observed at wells KAFB-106064 (20.3 µg/L), KAFB-106EX1 (12.9 µg/L), and KAFB-106MW2-S (15 µg/L) after the one-month passive period. This is slightly less than a one-log reduction (i.e., 90%), as indicated in Table 17. Decreases of similar magnitude were not observed for benzene and toluene, where losses were less than 25% and, in most cases, less than 10% with some increases in concentration. These observations are consistent with some ongoing EDB degradation that may have been further stimulated by groundwater recirculation and nutrient redistribution from other locations within the aquifer. Whether this apparent EDB degradation would have been sustained for longer periods was not assessed during this pilot test as Phase 2 recirculation and biostimulation activities commenced as planned after the approximately one-month passive period. Decreases in EDB concentrations were observed at the intermediate monitoring wells too, with losses up to 95%. However, these EDB reductions were mirrored in benzene and toluene data, and may be due to degradation or other processes, such as sorption in the soils or influx of unimpacted groundwater.

During the last sampling of the Phase 2 recirculation period, the range of EDB concentrations observed at shallow monitoring wells was less variable, ranging from 66.4 µg/L at KAFB-106MW1-S to a maximum of 90.9 µg/L at KAFB-106EX2. This indicated some redistribution of EDB within the treatment zone and provides a point of comparison for changes during the subsequent passive period. Except for KAFB-

106EX2, where no change in EDB concentration was observed, EDB concentrations decreased during the Phase 2 passive period by approximately 90% or more. As indicated in Table 17, this corresponds to one-log (90%) to three-log reduction (99.9%) relative to maximum concentrations measured during Phase 2 recirculation. Notably, EDB was not detected at the injection well (KAFB-106IN1) or KAFB-106MW2-S at the end of the passive period, with detection limits of approximately 0.02 µg/L. As mentioned earlier, no significant decreases of benzene and toluene were observed, providing evidence that abiotic losses (e.g. volatilization) were limited, and that anaerobic EDB degradation was stimulated during this passive period. As during the Phase 1 passive period, decreases in EDB concentrations were observed at the intermediate monitoring wells, but decreases in benzene and toluene were also observed, such that changes were not exclusive to EDB. In addition to EDB, benzene, and toluene degradation, other possible explanations leading to these decreases at intermediate wells include sorption in the soils or influx of unimpacted groundwater.

Due to the large decrease in EDB concentrations during Phase 2 and apparent *in situ* biodegradation activity of indigenous debrominating organisms, a decision was made to delay the planned bioaugmentation of the treatment zone with exogenous debrominating organisms (Kirtland AFB, 2018a). Instead, additional recirculation with more organic substrate and nutrients was performed during Phase 3 with the goal of expanding the biological treatment zone. In contrast to Phase 1 and Phase 2 recirculation activities and in contrast to other solutes (e.g., iodide, benzene, toluene), EDB concentrations observed during Phase 3 recirculation exhibited a new pattern. Measured EDB concentrations at the extraction wells were reasonably constant during this recirculation period, with concentrations at KAFB-106EX1 ranging from 11 µg/L to 20 µg/L, and concentrations at KAFB-106EX2 ranging from 47 µg/L to 97 µg/L. Based on flows through the treatment system from the extraction wells, EDB in the reinjected groundwater ranged from approximately 35 µg/L to 45 µg/L, yet concentrations at the monitoring wells were less, ranging from approximately 3 µg/L at KAFB-106064 to 11 µg/L at KAFB-106MW1-S. Notably, EDB concentrations also decreased at the shallow wells during this recirculation period with

time. Observing concentrations lower than injected concentrations and decreasing EDB concentrations during the recirculation period suggests that EDB degradation was stimulated and occurred between the injection well and the shallow monitoring wells during the Phase 3 recirculation period. Similar decreases in concentrations were not observed for benzene or toluene. Except for KAFB-106EX2 and KAFB-106MW1-S, where changes in EDB concentrations were less, EDB concentrations during the subsequent passive period decreased by 95% or more relative to maximums observed during the preceding recirculation period. As indicated in Table 17, these decreases corresponded to one-log (90%) to three-log reduction (99.9%) relative to maximum concentrations measured during Phase 3 recirculation, and EDB was detected at concentrations less than the EPA MCL of 0.05 µg/L (EPA, 2009) at the injection well (KAFB-106IN1) and wells KAFB-106MW2-S and KAFB-106064. As mentioned earlier, no significant losses of benzene and toluene were observed, providing evidence that abiotic losses (e.g. volatilization) were limited, and that anaerobic EDB degradation was stimulated during this passive period. Overall, the footprint of enhanced EDB degradation appeared larger after Phase 3 activities than during Phase 2. As during the Phase 1 and 2 passive periods, decreases in EDB concentrations were observed among the intermediate monitoring wells during Phase 3, but because similar decreases in benzene and toluene were also observed, such changes were not exclusive to EDB and could not be solely attributed to reductive debromination.

Phase 4 extended monitoring of the pilot test performance commenced after Phase 3, and five sampling rounds were performed, the first of which occurred approximately four months after Phase 3 recirculation activities were halted. There was no significant rebound in EDB concentrations during Phase 4. During Phase 4, EDB decreased to non-detectable concentrations at all wells except KAFB-106EX2 and KAFB-106MW2-S. Concentrations of EDB have decreased in KAFB-106EX2 from 55 µg/L (last Phase 3 passive sampling event) to 0.36 µg/L at the end of Phase 4. Concentrations of EDB have increased slightly in KAFB-106MW2-S from 0.019 µg/L (last Phase 3 passive sampling event) to 0.087 µg/L at the end of Phase 4. Figure 8 shows the EDB concentrations measured during baseline and Phase 4 sampling

events at all pilot test wells. Table 17 and Figure 32 show the overall extent of reduction in EDB, benzene, and toluene from baseline measurements (or the highest observed concentrations for intermediate wells) to the most recent Phase 4 sampling event (October 2020). EDB reductions were greater than 99% in all six shallow wells, with five of the wells exhibiting greater than three-log reductions (99.9%). Further, four of the shallow wells were below the EPA MCL of 0.05 µg/L (EPA, 2009) for EDB during their most recent sampling event (Figure 8). Reductions of benzene and toluene were more limited. The large and rapid reductions in EDB concentrations in an environment conducive to reductive debromination strongly suggests that *in situ* anaerobic biodegradation of EDB occurred.

EDB Degradation Products

Reductive debromination of EDB by various debrominating organisms often results in stoichiometric production of one mole of ethene and two moles of bromide for each mole of EDB reduced (Koster van Groos et al, 2018). Under reducing conditions, ethene can also be further transformed to ethane, and both gases as well as bromide are reasonably stable under anaerobic conditions. Elevated concentrations of these degradation products can provide additional evidence of reductive debromination of EDB under both baseline conditions and during pilot test efforts. During laboratory studies (Koster van Groos et al, 2018), a minor branching product of tentatively identified vinyl bromide was observed during slower EDB hydrolysis conditions, but vinyl bromide was not detected during anaerobic biodegradation studies. Sequential hydrogenolysis of EDB to bromoethane and then ethane is also possible (Henderson et al., 2008). Accurate measurement of trace concentrations of vinyl bromide or bromoethane products, as might be expected given relatively low parent EDB concentrations, is challenging and was not attempted during this pilot test.

Assuming stoichiometric conversion of EDB to ethene and ethane during reductive debromination and that contributions of ethene and ethane from sources other than EDB were negligible, quantities of EDB degraded by this mechanism were estimated using measured concentrations of ethene and ethane:

$$C_{EDB-degraded} = MW_{EDB} * \left(\frac{C_{ethene}}{MW_{ethene}} + \frac{C_{ethane}}{MW_{ethane}} \right)$$

where C indicates concentrations in units of mass per volume, and MW indicates the molecular weights of the respective compounds. Figures 33 and 34 show estimated quantities of EDB degraded through this mechanism based on the formation of ethene and ethane products observed at the shallow and intermediate wells, respectively. In shallow wells, estimates of EDB degraded to ethene and ethane during the baseline evaluation ranged from approximately 20 $\mu\text{g/L}$ at KAFB-106EX1 to over 130 $\mu\text{g/L}$ at both KAFB-106064 and KAFB-106MW2-S, indicating that there was likely EDB debromination occurring prior to any pilot test activities. During the Phase 1 recirculation period, these estimates of EDB degraded decreased and ranged from 5 $\mu\text{g/L}$ (KAFB-106MW2-S and KAFB-106EX2) to 24 $\mu\text{g/L}$ (KAFB-106064). Many geochemical measures (e.g., sulfate, iron, methane) indicated more oxidizing conditions during this recirculation period, which may be attributed to redistribution of the low concentrations of DO observed at KAFB-106EX1 throughout the treatment zone. The small quantities of DO introduced during this process may have helped facilitate some ethene and ethane consumption. During the Phase 1 passive period, increases in estimates of EDB degraded based on ethene and ethane were noted, which is consistent with the decreases in EDB concentrations during this period described earlier, providing further evidence of EDB degradation prior to biostimulation efforts.

During and after the Phase 2 recirculation period, estimates of EDB degraded based on ethene and ethane increased to magnitudes similar to initial EDB concentrations, suggesting substantial conversion. The highest such estimate of EDB degraded occurred at KAFB-106MW1-S after Phase 3 biostimulation efforts with an estimated concentration of approximately 270 $\mu\text{g/L}$. This is also the location where the

highest initial EDB concentrations were noted during the baseline evaluation with a concentration of over 400 µg/L. During Phase 4, the highest estimate of EDB degraded occurred at KAB-106EX2 with an estimated maximum concentration of approximately 309 µg/L. Extraction well KAFB-106EX2 also had a high initial EDB concentration of 143 µg/L measured during the baseline evaluation, and NAPL was observed in this well during Phase 4. Decreases in ethene and ethane occurred with time at several wells during passive periods, despite large EDB reductions at these locations. This decrease in ethene and ethane could indicate slowed production of these compounds due to the lower parent EDB concentrations, together with some ethene or ethane degradation or partitioning into gas-phase pockets that may be present due to methanogenesis. As described in Section 4.4, very high methane concentrations were observed at several wells that could reflect the presence of gas-phase methane.

Reductive debromination of EDB can result in the production of two moles of bromide for each mole of EDB degraded. Two challenges for examining bromide released during this process are the presence of bromide in background water and that expected bromide released from EDB could be quite small. For example, degradation of 100 µg/L of EDB results in release of just 0.085 mg/L of bromide, which may be challenging to measure. One method for distinguishing the release of bromide from background water is to examine the ratio of bromide to chloride as these anions are typically correlated due to their frequent common sources. Deviation from a constant ratio in favor of greater bromide might indicate a unique source of bromide, such as EDB debromination.

Figure 35 shows concentrations of bromide vs. chloride for all the wells of the pilot test, and Figures 36 and 37 show the bromide to chloride ratio with time for the shallow and intermediate wells, respectively. The dashed red line in each of these figures approximates the background ratio of 0.0079 based on previous studies (Kirtland AFB, 2016b). Examining these figures, very few samples were enriched in chloride relative to bromide compared to the background, but many samples were enriched in bromide. The largest apparent increase in bromide to chloride ratio occurred during and after the Phase 3

recirculation period. This coincided with use of a new certified analytical laboratory after the original analytical laboratory measuring bromide ceased operations. There was also a significant increase in bromide to chloride ratio in shallow wells KAFB-106EX1, KAFB-106MW2-S, and KAFB-106MW1-S towards the end of Phase 4. Several of the increases in bromide appear to be on the order of 1 mg/L, which corresponds to degradation of approximately 1,200 µg/L of EDB – much more than was observed in aqueous phase measurements during the pilot test. One explanation for this large excess of bromide could be stimulation of debrominating organisms within the treatment zone and continuing release and degradation of EDB from a separate phase source (e.g. NAPL), which would certainly be of interest.

Carbon Isotope Analysis of EDB

Examining the isotope composition of pollutants provides a novel measure of their degradation (Hunkeler et al., 2008, Wilson et al., 2008). As EDB degrades, its carbon (C) stable isotope composition can change as EDB with a heavy C isotope substitution (^{13}C) degrades slightly slower than EDB with only ^{12}C (Koster van Groos et al, 2018). Biological and abiotic degradation of EDB both result in changes in the isotope composition of EDB, and differences in reaction rates between the two EDB species are generally within 4% of each other. The isotope composition of EDB does not shift as a result of dilution and volatilization is expected to have negligible impact on isotope composition under site conditions. As such, a shift in EDB $\delta^{13}\text{C}$ from more negative values to more positive values (corresponding to an increase in relative ^{13}C abundance) provides additional evidence of EDB degradation. Figure 38 shows $\delta^{13}\text{C}$ values of EDB sampled at shallow monitoring wells during the pilot test, as well as of EDB extracted from the NAPL recovered at well KAFB-106MW1-S during baseline studies. Unfortunately, it was not possible to measure the isotope composition of each sample, as low EDB concentrations and high concentrations of other VOCs, such as benzene and toluene complicated the analyses.

The $\delta^{13}\text{C}$ values of EDB in the NAPL sample and at well KAFB-106EX2 were consistently the most negative with values of -16‰ or lower, which indicates they were the least degraded. This is consistent

with the other measures of EDB degradation discussed earlier and as shown in Table 17 and Figure 32. The baseline evaluation performed with samples collected prior to the pilot test included EDB $\delta^{13}\text{C}$ values as high as -5‰, significantly higher than the EDB of the NAPL and located at KAFB-106EX2, indicating significant isotope fractionation and providing further evidence of EDB degradation under ambient conditions at the site prior to the pilot test. $\delta^{13}\text{C}$ values of EDB during passive periods of the pilot test were typically more positive than preceding recirculation periods, providing further evidence of enhanced degradation during passive periods. $\delta^{13}\text{C}$ of EDB at KAFB-106064 and KAFB-106MW2-S increased between baseline measurements and the first passive period, suggesting EDB degradation after initial recirculation efforts prior to the introduction of biostimulation amendments, consistent with observed decreases in EDB concentration at these locations. The highest $\delta^{13}\text{C}$ value of EDB (+5‰) was from a sample collected at KAFB-106EX1 during the Phase 2 passive period and represents a large shift in isotope composition and significant EDB degradation. We suspect, however, that if isotope analyses were feasible with lower concentration samples, even higher $\delta^{13}\text{C}$ values would have been observed at several of the wells. Overall, the increases in $\delta^{13}\text{C}$ values of EDB observed provide strong supporting evidence that EDB degraded during the pilot test. Additionally, while isotope fractionation can result from both biological and abiotic degradation mechanisms, the relatively rapid shifts and other lines of evidence noted during the pilot test suggest that the shift in isotope composition was likely the result of biodegradation processes.

5. CONCLUSIONS

5.1 Conclusions

The primary objective of this pilot test was to demonstrate anaerobic ISB as a treatment technology targeting EDB in impacted groundwater at Kirtland AFB. Based on the pilot test data reviewed here, the following conclusions regarding the effectiveness of ISB for EDB treatment were made:

- Enhanced ISB of EDB was successfully demonstrated (see Figure 32 and Figure 8). EDB degradation was evident during the pilot test with a greater than two-log reduction (>99%) at all wells examined. While meeting the EPA MCL of 0.05 µg/L was not a specific objective of the pilot test, only two of the wells, KAFB-106MW2-S (0.087 µg/L) and KAFB-106EX2 (0.36 µg/L), exceeded this level during the October 2020 sampling event. EDB degradation was evident through comparison with benzene and toluene concentrations, and the production of EDB degradation products ethene, ethane, and bromide suggested that this degradation occurred by reductive debromination. Higher EDB $\delta^{13}\text{C}$ values (observed to be as high as +5‰ at KAFB-106EX1) provided additional isotopic evidence of EDB degradation.
- Baseline measurements indicated that EDB was likely degrading prior to the pilot test. QuantArray-Chlor analyses indicated that microorganisms likely capable of degrading EDB were present during the baseline assessment and throughout the pilot test. During the baseline assessment, degradation products of reductive debromination (e.g., ethene, ethane, bromide) were present in the groundwater and EDB was observed to have more positive $\delta^{13}\text{C}$ values (up to -5‰). These all indicate EDB degradation prior to ISB treatment.
- Tracer and biostimulation amendments were distributed throughout the treatment zone, with highest concentrations of iodide and propionate observed at wells KAFB-106MW1-S, KAFB-106MW2-S, and KAFB-106064 (see Figure 13 and 17). The continued presence and

consistency among iodide concentrations through Phase 4 indicates that groundwater influx at the site has been limited.

- Measurements of DO, sulfate, iron, and methane indicate that reducing conditions favorable for reductive debromination of EDB were achieved throughout the site.
- During the pilot test, the performance of one extraction well (KAFB-106EX2) and the injection well (KAFB-106IN1) deteriorated, but the performance of these wells remained sufficient to finish the pilot test. Well maintenance such as mechanical and/or chemical rehabilitation may be required for long-term viability.
- Continued quarterly monitoring at all nine pilot test wells for the parameters specified in the Work Plan (Kirtland AFB, 2016a) may be unnecessary, and it is recommended that future monitoring proceed only at wells KAFB-106063 and KAFB-106064 in accordance with the most recently approved groundwater monitoring work plan. Based on recent groundwater results and in accordance with the Work Plan (Kirtland AFB, 2016a), sampling at seven wells associated with the pilot test should be complete (KAFB-106MW1-S, KAFB-106MW1-I, KAFB-106MW2-S, KAFB-106MW2-I, KAFB-106EX1, KAFB-106EX2, and KAFB-106IN1). Significant rebound of EDB was not observed during Phase 4 passive monitoring and sampling a subset of pilot test groundwater monitoring wells consistent with site-wide monitoring efforts can provide representative information regarding long-term pilot test performance.
- The pilot test is complete and it is recommended that aboveground components of the groundwater recirculation system and other infrastructure be removed from the site. No final remedy has been selected at this time for the BFF site and this equipment is currently not required. All groundwater monitoring, extraction, and injection wells associated with the pilot test will remain in place.

6. REFERENCES

- Air Force Center for Environmental Excellences (AFCEE, Naval Facilities Engineering Service enter (NFESC) and the Environmental Security Technology Certification Program (ESTCP). 2004 Principles and Practices of Enhances Anaerobic Bioremediation of Chlorinated Solvents. Prepared by the Parsons Corporation, Denver, Colorado. August (available at https://frtr.gov/costperformance/pdf/remediation/principles_and_practices_bioremediation.pdf).
- CH2M HILL. 2001. *Stage 1 Abatement Plan Report for the Bulk Fuels Facility (ST-106)*. Kirtland Air Force Base, New Mexico. May 21.
- EPA. 2009. *National Primary Drinking Water Regulations*, EPA 816-F 09-004, U.S. Environmental Protection Agency, Washington, D.C.
- Hunkeler, D., Meckenstock, R. U., Sherwood Lollar, B., Schmidt, T. C., & Wilson, J. T. 2008. A Guide for Assessing Biodegradation and Source Identification of Organic Ground Water Contaminants using Compound Specific Isotope Analysis (CSIA), EPA 600/R-08/148. *USEPA Publication*, (December), 1–82. <https://doi.org/EPA/600/R-08/148>.
- Justicia-Leon, S. D., Ritalahti, K. M., Mack, E. E., & Löffler, F. E. 2012. Dichloromethane fermentation by a Dehalobacter sp. in an enrichment culture derived from pristine river sediment. *Applied and Environmental Microbiology*, 78(4), 1288–1291. <https://doi.org/10.1128/AEM.07325-11>.
- Koster Van Groos, P. G., Hatzinger, P. B., Streger, S. H., Vainberg, S., Philp, R. P., & Kuder, T. 2018. Carbon Isotope Fractionation of 1,2-Dibromoethane by Biological and Abiotic Processes. *Environmental Science and Technology*, 52(6). <https://doi.org/10.1021/acs.est.7b05224>.
- Kuder, T., Wilson J.T., Philip, P., He, Y.T. 2012. Carbon Isotope Fractionation in Reactions of 1,2-Dibromoethane with FeS and Hydrogen Sulfide. *Environ. Sci. Technol.* 46, 7495-7502.
- Moe, W. M., Yan, J., Nobre, M. F., da Costa, M. S., & Rainey, F. A. 2009. Dehalogenimonas lykanthroporepellens gen. nov., sp. nov., a reductively dehalogenating bacterium isolated from chlorinated solvent-contaminated groundwater. *International Journal of Systematic and Evolutionary Microbiology*, 59(11), 2692–2697. <https://doi.org/10.1099/ij.s.0.011502-0>.
- NMED. 2019. February 25, 2019 correspondence from Mr. John Kieling, Bureau Chief to Colonel Richard W. Gibbs, Base Commander, 377 AB/CC, Kirtland AFB, NM and Mr. Chris Segura, Chief, Installation Support Section, AFCEC/CZOW, Kirtland AFB, NM, re: *Bulk Fuels Facility Spill, Solid Waste Management Unit ST-106/SS-11, Kirtland Air Force Base, EPA ID# NM9570024423*,

HWB-KAFB-19-MISC.

NMED. 2018. August 7, 2018 correspondence from Mr. Juan Carlos Borrego, Deputy Secretary, Environment Department, to Colonel Richard W. Gibbs, Base Commander, 377 AB/CC, Kirtland AFB, NM and Mr. Chris Segura, Chief, Installation Support Section, AFCEC/CZOW, Kirtland AFB, NM, *re: Phase 3 Ethylene Dibromide In Situ Biodegradation Pilot Test, Notification letter, Bulk Fuels Facility, Solid Waste Management Unit ST-106/SS-11, Kirtland Air Force Base, EPA ID# NM9570024423, HWB-KAFB-13-MISC.*

NMED. 2017. Correspondence email from Diane Agnew, NMED HWB to Adria A. Bodour, AFCEC/CZRX, RE: Requesting NMED Approval for Development Postpone of Monitoring, Extraction, and Injection Wells for EDB Bioremediation Pilot Test Work Plan, January 30.

NMED. 2010. Hazardous Waste Treatment Facility Operating Permit, EPA ID No. NM9570024423, Issued to U.S. Air Force for the Open Detonation Unit Located at Kirtland Air Force Base, Bernalillo County, New Mexico, by the NMED Hazardous Waste Bureau. July.

Kirtland AFB. 2018a. *Phase 3 Ethylene Dibromide In Situ Biodegradation Pilot Test, Notification letter, Bulk Fuels Facility, Kirtland Air Force Base, New Mexico.* Prepared by Aptim Federal Services, LLC for Kirtland AFB under USACE Contract No. W9128F-12-D-0003, Task Order 0025. July.

Kirtland AFB, 2018b. Quarterly Report – April-June 2018, Bulk Fuels Facility, Solid Waste Management Unit ST-106/SS-111, Kirtland Air Force Base, New Mexico. Prepared by EA Engineering, Science, and Technology, Inc., PBC for Kirtland AFB under USACE Contract No. W912DR-12-D-0006, Delivery Order DM01. September.

Kirtland AFB. 2017a. *Borehole Abandonment Activities Report, Performed as part of the construction effort for the Ethylene Dibromide In Situ Biodegradation Pilot Test, Bulk Fuels Facility, Kirtland Air Force Base, New Mexico.* Prepared by Aptim Federal Services, LLC for Kirtland AFB under USACE Contract No. W9128F-12-D-0003, Task Order 0025. March.

Kirtland AFB. 2017b. *Corrective Action Report fo Accidental Soil Release, Kirtland Air Force Base, New Mexico.* Prepared by Aptim Federal Services, LLC for Kirtland AFB under USACE Contract No. W9128F-12-D-0003, Task Order 0025. February.

Kirtland AFB. 2017c. Quarterly Monitoring Report April-June 2016, Bulk Fuels Facility, Solid Waste Management Unit ST-106/SS-111. Prepared by EA Engineering, Science, and Technology, Inc.,

- PBC for Kirtland AFB under USACE Contract No. W912DR-12-D-0006, Delivery Order DM01. March.
- Kirtland AFB. 2016a. *Ethylene Dibromide In Situ Biodegradation Pilot Test Work Plan, Bulk Fuels Facility, Kirtland Air Force Base, New Mexico*. Prepared by CB&I Federal Services, LLC. for Kirtland AFB under USACE Contract No. W9128F-12-D-0003, Task Order 0025. December.
- Kirtland AFB. 2016b. Quarterly Pre-Remedy Monitoring and Site Investigation Report for October – December 2015 and Annual Report for 2015, Bulk Fuels Facility, Solid Waste Management Unit ST-106/SS-111. Prepared by CB&I Federal Services, LLC. Kirtland AFB under USACE Contract No. W912DY-10-D-0014, Delivery Order 0002. April.
- Kirtland AFB. 2016c. Quarterly Monitoring Report, October-December 2016 and Annual Report for 2016, Bulk Fuels Facility, Solid Waste Management Unit ST-106/SS-111. Prepared by EA Engineering, Science, and Technology, Inc., PBC for Kirtland AFB under USACE Contract No. W912DR-12-D-0006, Delivery Order DM01. September.
- Kirtland AFB. 2011a. *Interim Measures Work Plan, Bulk Fuels Facility (BFF) Spill, Solid Waste Management Units ST-106 and SS-111, Kirtland Air Force Base, Albuquerque, New Mexico*. Prepared by Shaw Environmental & Infrastructure, Inc. for Kirtland AFB under USACE Contract No. W912DY-10-D-0014, Delivery Order 0002. March.
- Kirtland AFB. 2011b. *Groundwater Investigation Work Plan, Bulk Fuels Facility (BFF) Spill, Solid Waste Management Units ST-106 and SS-111, Kirtland Air Force Base, Albuquerque, New Mexico*. Prepared by Shaw Environmental & Infrastructure, Inc. for Kirtland AFB under USACE Contract No. W912DY-10-D-0014, Delivery Order 0002. March.
- USGS. 2016. *Definition of Land Survey Objective / Measuring Points and Land Survey Campaign among the Kirtland Air Force Base Monitoring Well Network*. Prepared by the USGS for Kirtland AFB.
- Wilson, J. T., Banks, K., Earle, R., He, Y., Kuder, T., & Adair, C. (2008). Natural attenuation of the lead scavengers 1,2-dibromoethane (EDB) and 1,2-dichloroethane (1,2-DCA) at motor fuel release sites and implications for risk management. *EPA Report 600/R-08/107*. U.S. EPA, Office of Research and Development, National Risk Management Research Laboratory, Ada, OK., (September), 1–74. Retrieved from <http://purl.access.gpo.gov/GPO/LPS77736>.

FIGURES

TABLES

APPENDICES
(ALL APPENDICES PROVIDED SEPARATELY ON CD)

**APPENDIX A
NMED NOTICE OF DISAPPROVAL, RESPONSE TO COMMENTS
TABLE, AND REDLINED REVISED FINAL REPORT**

**APPENDIX B
SITE PHOTOGRAPHS**

**APPENDIX C
APPROVED PERMITS**

**APPENDIX D
WELL INSTALLATION FORMS**

**APPENDIX E
BOREHOLE ABANDONMENT AND DEVIATION TEST
DOCUMENTATION**

**APPENDIX F
FINAL PILOT TEST SYSTEM DESIGN DRAWINGS AND
SPECIFICATION SHEETS**

F-1. Final Design Drawings

F-2. Specification Sheets

**APPENDIX G
SAFETY DATA SHEETS**

APPENDIX H FIELD SAMPLING RECORDS

H-1. Groundwater Purge Logs

H-2. Sample Collection Logs

APPENDIX I DATA QUALITY EVALUATION REPORT AND DATA PACKAGES

I-1. Data Quality Evaluation Report (June 2017 – January 2019)

I-2. Data Quality Evaluation Report (March 2020 – October 2020)

I-3. Data Packages

**APPENDIX J
WASTE DISPOSAL DOCUMENTATION**

J-1. Soil IDW Disposal Letters and Approvals

J-2. Corrective Action Report

J-3. Non-Hazardous Waste Manifests

J-4. Hazardous Waste Manifests

J-5. Waste Profiles

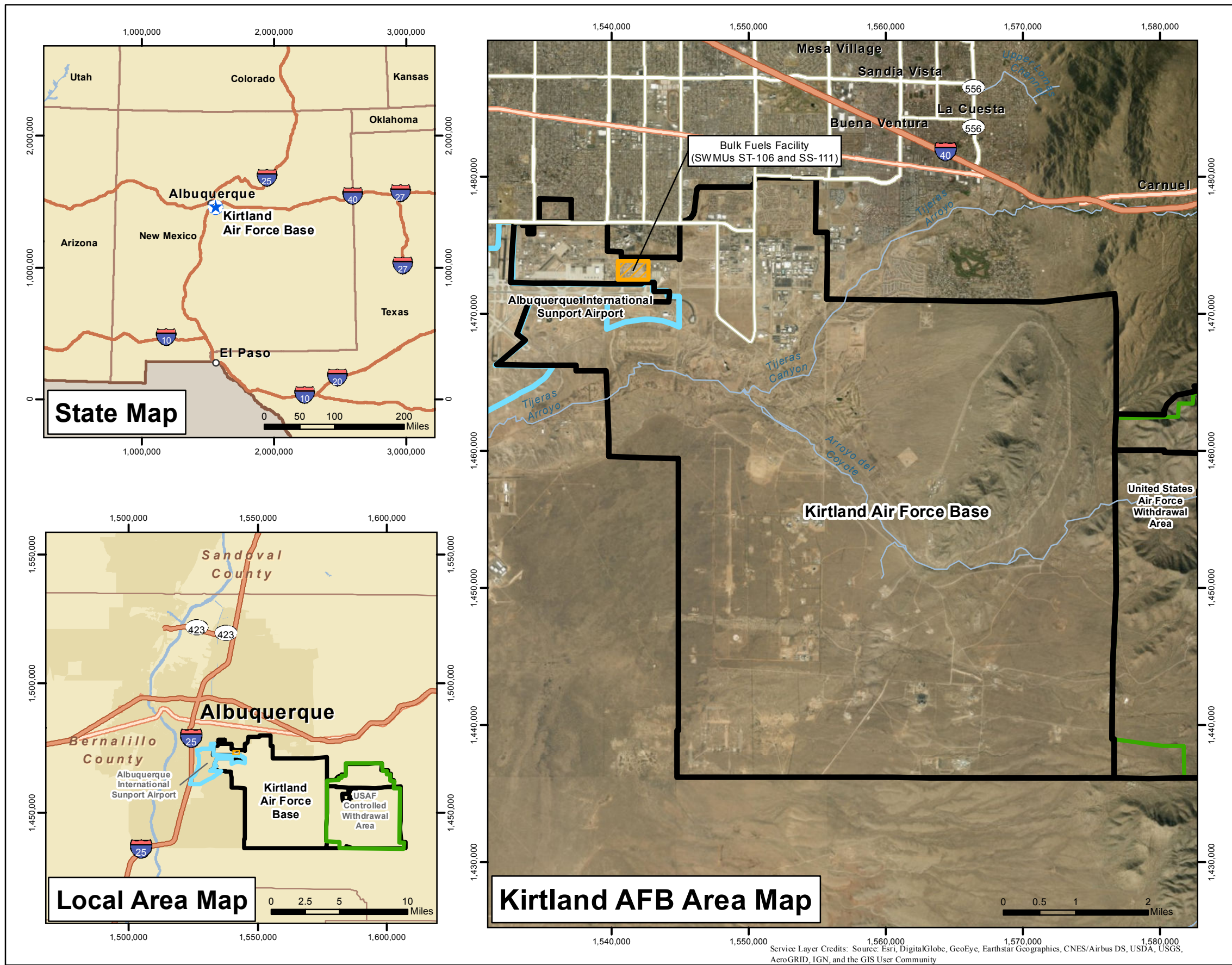

Legend

- Installation Location
- Kirtland Air Force Base
- Installation Boundary
- Bulk Fuels Facility (SWMUs ST-106 and SS-111)
- Albuquerque International Sunport Airport
- United States Air Force Withdrawal Area
- Major Highways
- Highways
- Major Roads
- Rivers
- Urban Areas
- Counties
- States

SWMUs = Solid Waste Management Unit
 AFB = Air Force Base
 USAF = United States Air Force

N Revision Date: 02/20/19

Projection : NAD83 State Plane New Mexico Central FIPS3002 Feet

ETHYLENE DIBROMIDE IN SITU BIODEGRADATION
 PILOT TEST REPORT
 KIRTLAND AIR FORCE BASE, NEW MEXICO

FIGURE 1

AREA LOCATION MAP



- Legend**
- Continuous Core Location
 - Existing Monitoring Well
 - Pilot Test Injection/Extraction Well
 - Pilot Test Monitoring Well
 - Fence Line
 - Natural Gas Line
 - Wastewater Line
 - Water Line
 - Electrical Cable Line
 - Construction Fence
 - Truck Exit Route
 - Pilot Test Trench Location for Water Pipe and Subsurface Electrical
 - Pilot Test System Location
 - Pilot Test Existing Electrical Tie-in
 - Electrical Service Line
 - Storage Shed
- KAFB = Kirtland Air Force Base

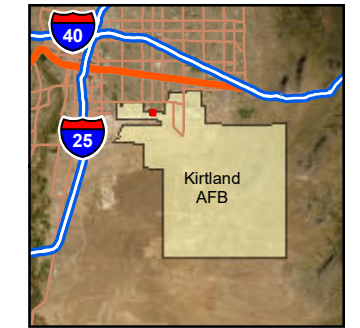

SITE LOCATION

Source: Esri, DigitalGlobe, GeoEye, Earthstar Geographics, CNES/Airbus DS, USDA, USGS, AeroGRID, IGN, and the GIS User Community

Revision Date:

0 15 30 60
Feet
1 inch = 60 feet

ETHYLENE DIBROMIDE IN SITU BIODEGRADATION
PILOT TEST REPORT
KIRTLAND AIR FORCE BASE, NEW MEXICO

FIGURE 2

SITE LOCATION MAP

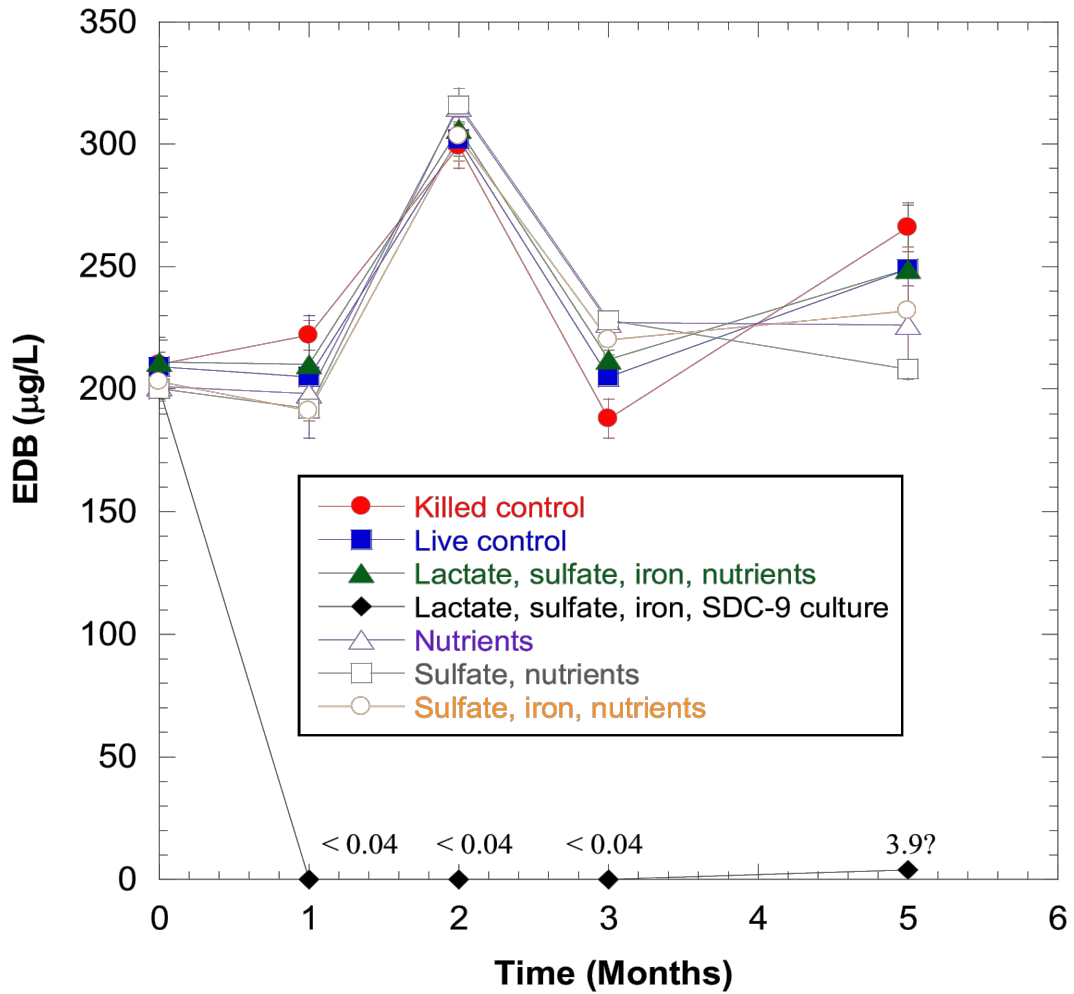

Note: the treatments that were amended with the dehalogenating culture SDC-9 showed increased degradation of EDB.

 APTIM	APTIM 17 Princess Road Lawrenceville, New Jersey 08648
	ETHYLENE DIBROMIDE IN-SITU BIODEGRADATION PILOT TEST REPORT KIRTLAND AIR FORCE BASE, NEW MEXICO
FIGURE 3 CONCENTRATIONS OF EDB IN ANAEROBIC MICROCOSMS PREPARED WITH AQUIFER SAMPLES COLLECTED FROM THE BFF SOURCE AREA	

File: O:\project\LANTDIV\Kirtland AFB\501397\501397-A1.dwg
 Plot Date/Time: Feb 23, 2021 - 12:38pm
 Xref: APTIM Logo Standard Color.jpg
 Plotted By: bernadette.oconnor

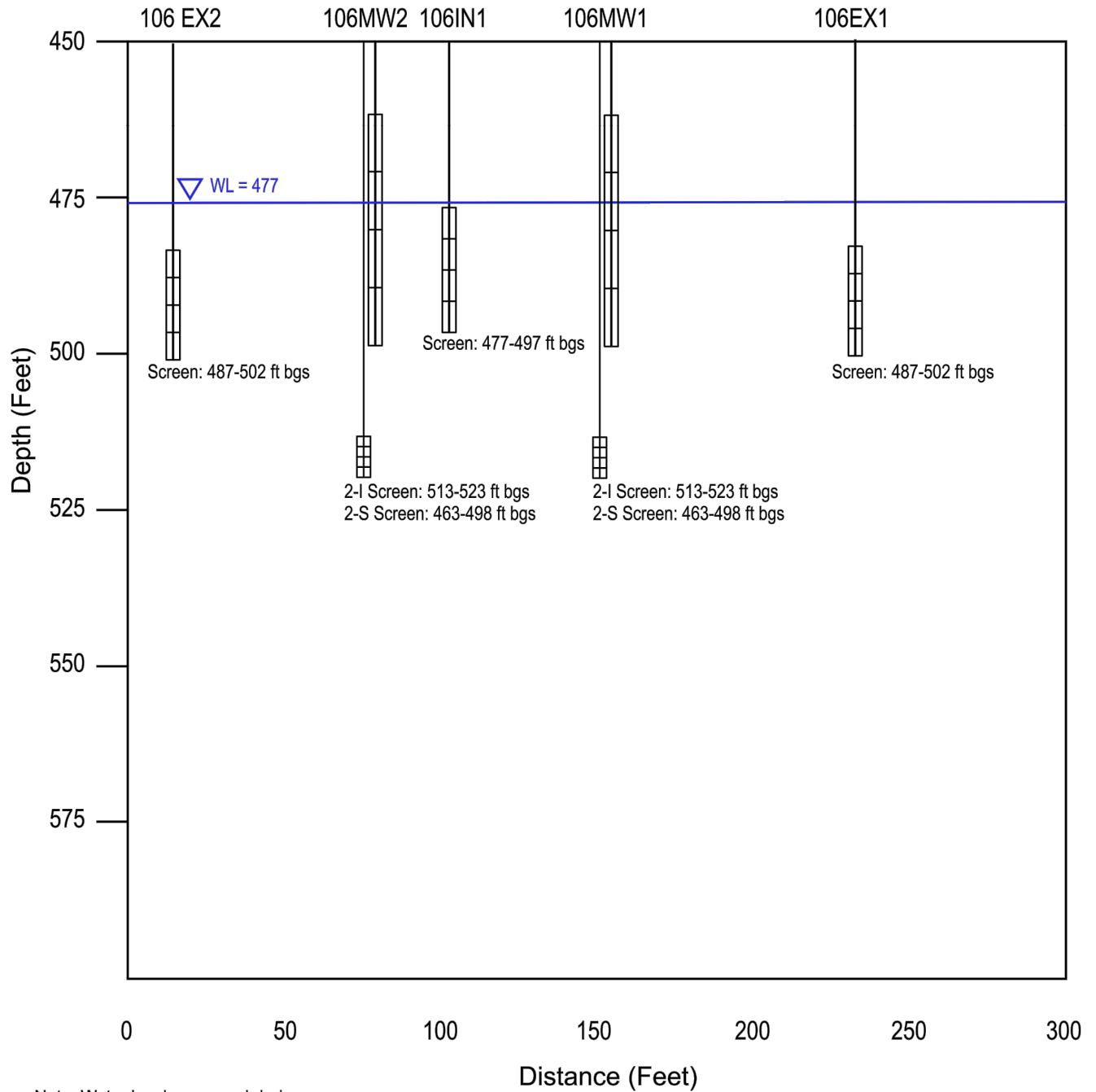

Note: Water level measured during drilling and well installation activities

LEGEND:

 106MW1-S	SCREEN INTERVAL
EX = Extraction Well IN = Injection Well MW = Monitoring Well ft bgs = feet below ground surface	

 APTIM	APTIM 17 Princess Road Lawrenceville, New Jersey 08648
ETHYLENE DIBROMIDE IN-SITU BIODEGRADATION PILOT TEST REPORT KIRTLAND AIR FORCE BASE, NEW MEXICO	
FIGURE 4 PILOT TEST WELL LAYOUT	

FILE: R:\PROJECTS\500433 - RAPID Kirtland EDB\Design\500433-D1.dwg
 Plot Date/Time: Feb 27, 2019 - 10:05am
 Plotted By: Graig Lavorgna

OFFICE: Lawrenceville, NJ
 DESIGNED BY: G.Lavorgna
 DRAWN BY: G.Lavorgna
 CHECKED BY: S.Sheedy
 APPROVED BY: P.KostervanGroos
 DRAWING NUMBER: 500433-D1

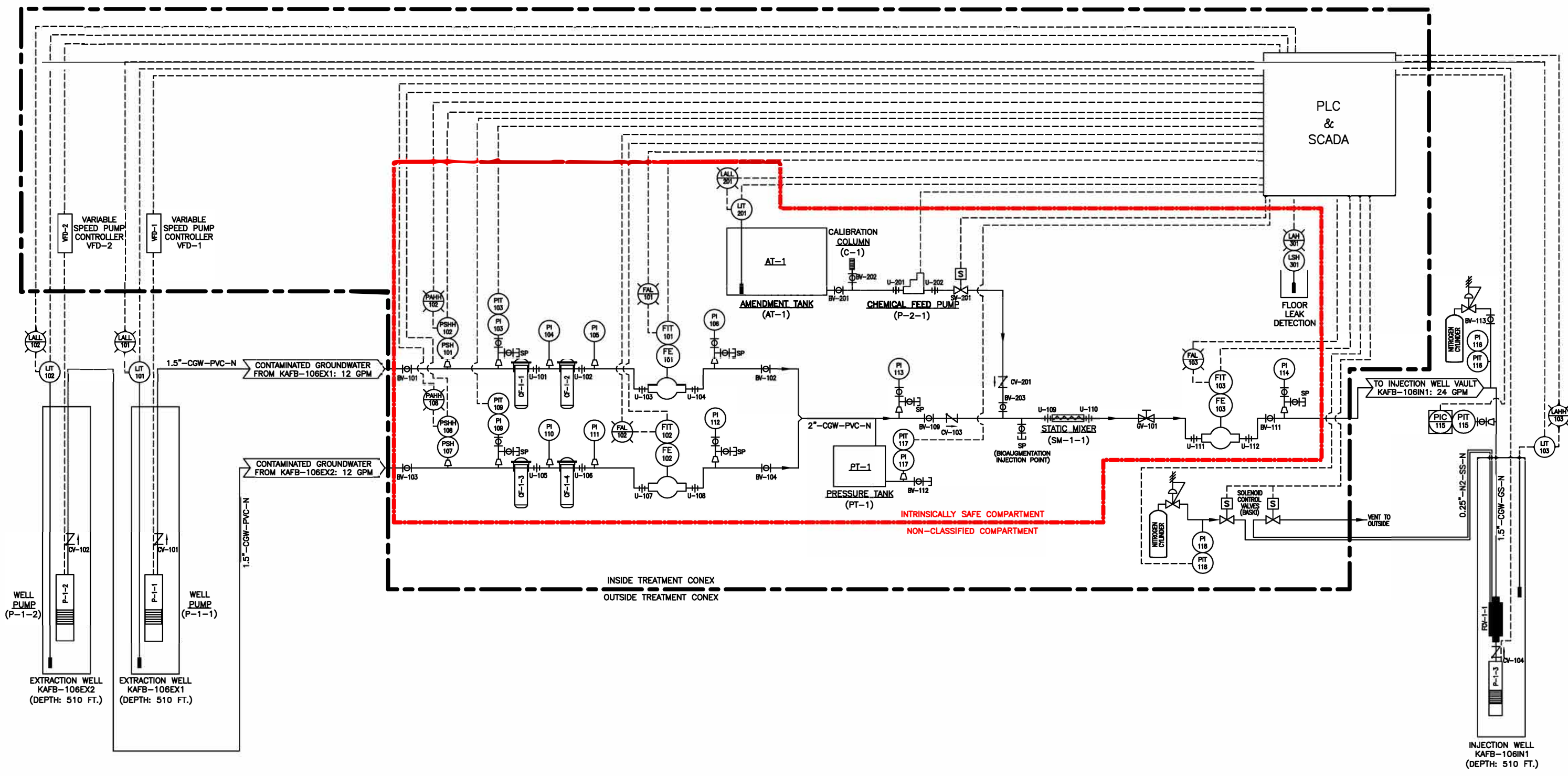



P-1-1, P-1-2 EXTRACTION WELL PUMP TYPE: SUBMERSIBLE FLOW: 15GPM@575' MOTOR: FRANKLIN, 5HP, 460V, 3PH MODEL: 25SS0-26 (Teflon) MFR: GRUNDFOS	VFD-1, VFD-2 PUMP CONTROLLER TYPE: 60HZ FREQ CONVERTER ENCLOSURE: IP55, A5 ELECTRIC: 3X440-500V MODEL: CUE (part#91136938) MFR: GRUNDFOS	FIQ-101, FIQ-102, FIQ-103 FLOW METER TYPE: MAGNETIC FLOW SENSOR PIPE RANGE: 1/2"-4" MODEL: 2551 MAGMETER PART#: 3-2551-PO-42 MFR: GF SIGNET	PT-1 PRESSURE TANK TYPE: DIAPHRAGM TANK VOLUME: 31.8 GAL PRE-CHARGE: 12 PSI INLET: 1" NPTF MODEL: V100 MFR: GOULDS	AT-1 AMENDMENT TANK TYPE: VERTICAL POLY TANK DIMENSIONS: 52"x66", 550GAL OUTLET: 2" BULKHEAD MODEL: NTO (VT0550-52) MFR: ACE ROTO-MOLD	P-2-1 CHEMICAL FEED PUMP TYPE: ELECTRONIC METERING CAPACITY: 2.5 GPH, 150 PSI VOLTAGE: 120 VAC MODEL: E71 MFR: LMI	PIT-111 PRESSURE TRANSMITTER TYPE: INTRINSICALLY SAFE RANGE: 1-30 PSI SETPOINT: 5-10 PSI MODEL: 2088 MFR: ROSEMOUNT	FCV-1-1 FLOW CONTROL VALVE TYPE: PNEUMATIC SIZE: 4" OD MODEL: INFLEX FCV MFR: BASKI INCLUDES CONTROL PANEL WITH NITROGEN REGULATOR	P-1-3 INJECTION WELL PUMP TYPE: SUBMERSIBLE FLOW: 3GPM@550' MOTOR: 1HP, 230V, 8.1A MODEL: 5SQE10-410 (Teflon) MFR: GRUNDFOS
---	--	---	---	--	--	---	---	---

APTIM
 Aptim Federal Services
 17 Princess Road
 Lawrenceville, New Jersey 08648

U.S. ARMY CORPS OF ENGINEERS
 OMAHA DISTRICT
 OMAHA, NEBRASKA

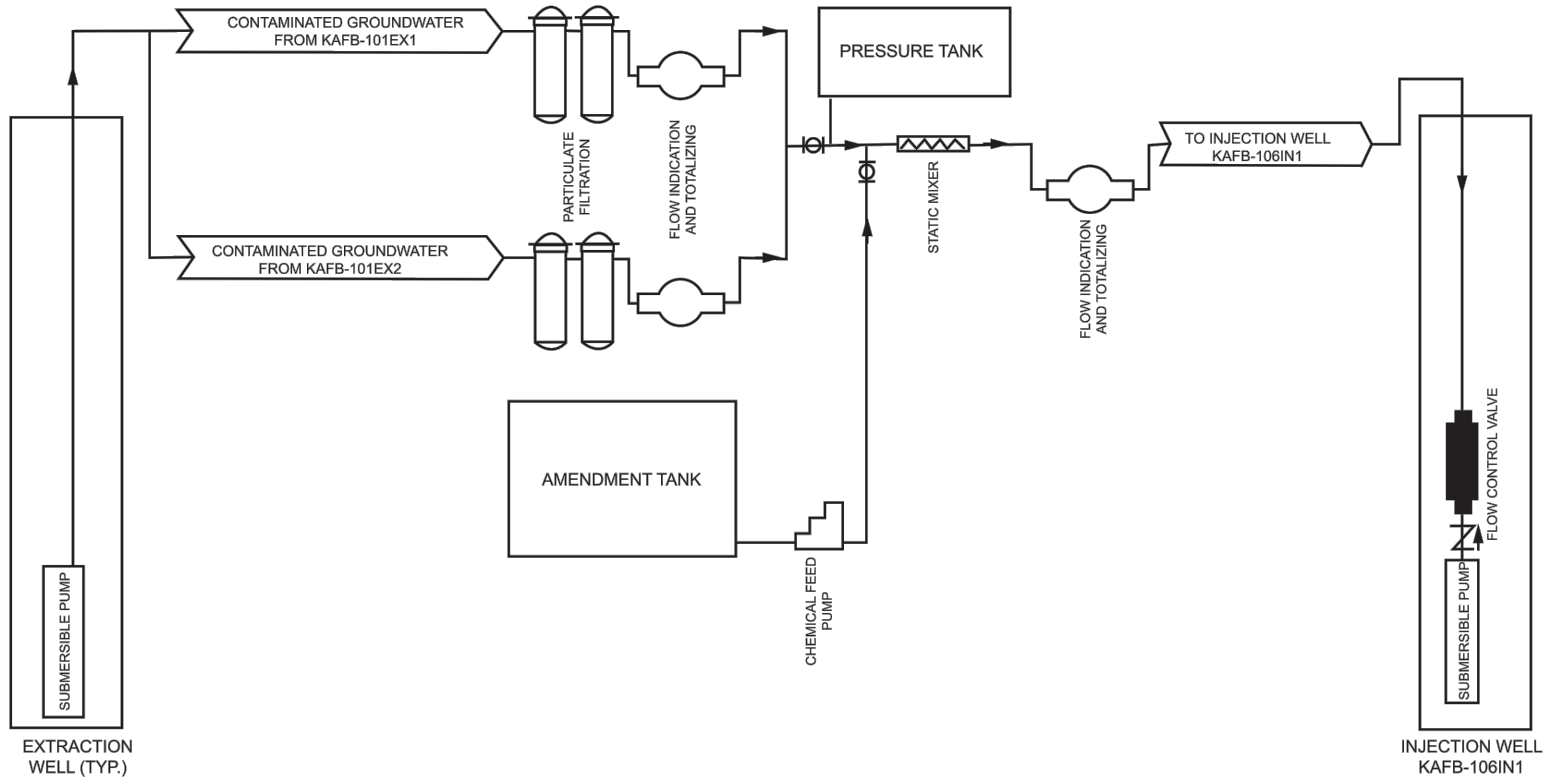
FIGURE 5
 RECIRCULATION AND AMENDMENT SYSTEM
 PIPING AND INSTRUMENTATION DIAGRAM
 EDB IN SITU BIODEGRADATION PILOT TEST
 REPORT, KIRTLAND AFB, NEW MEXICO



	APTIM 17 Princess Road Lawrenceville, New Jersey 08648
ETHYLENE DIBROMIDE IN-SITU BIODEGRADATION PILOT TEST REPORT KIRTLAND AIR FORCE BASE, NEW MEXICO	
FIGURE 6 PROCESS FLOW DIAGRAM	

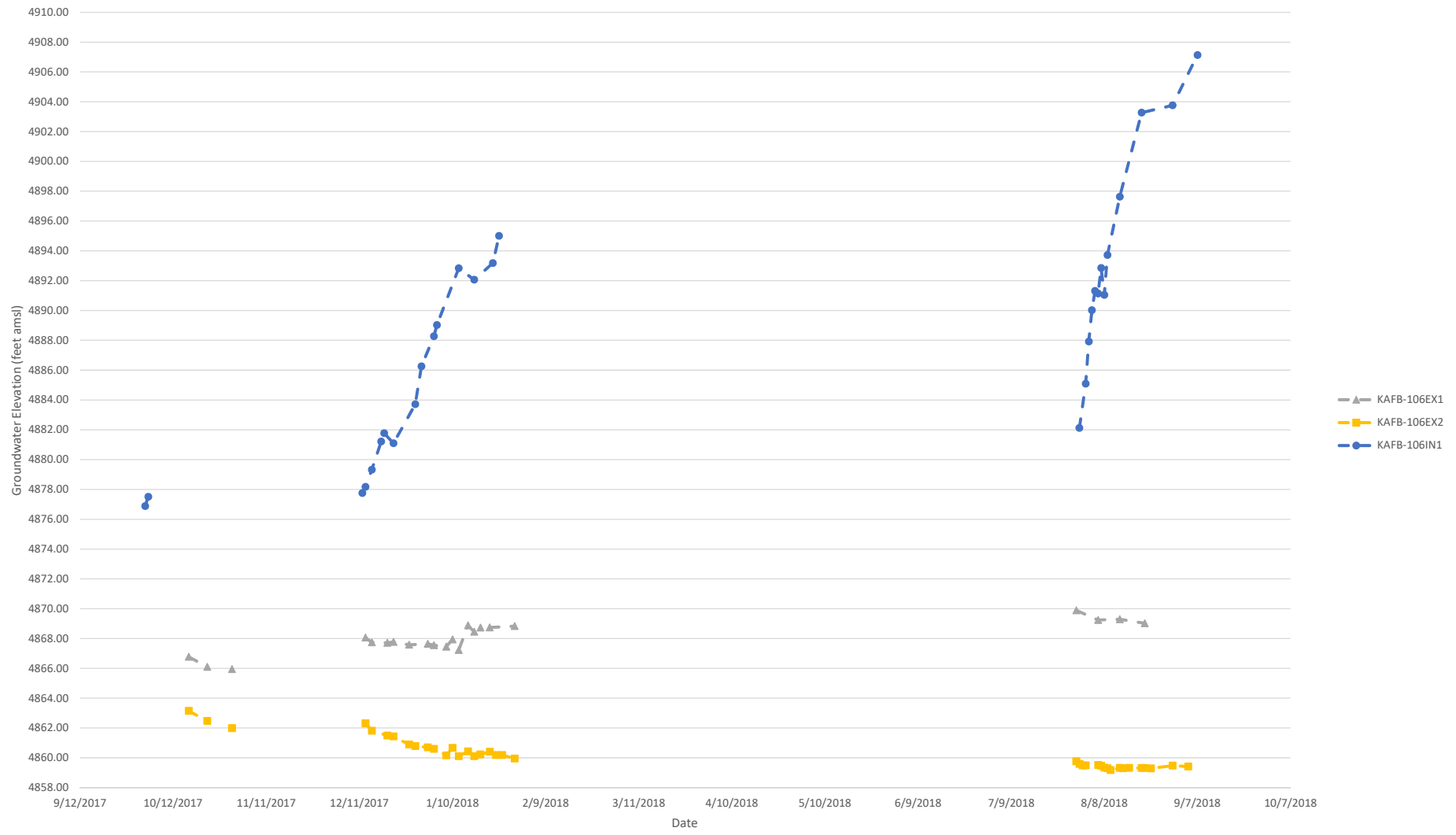

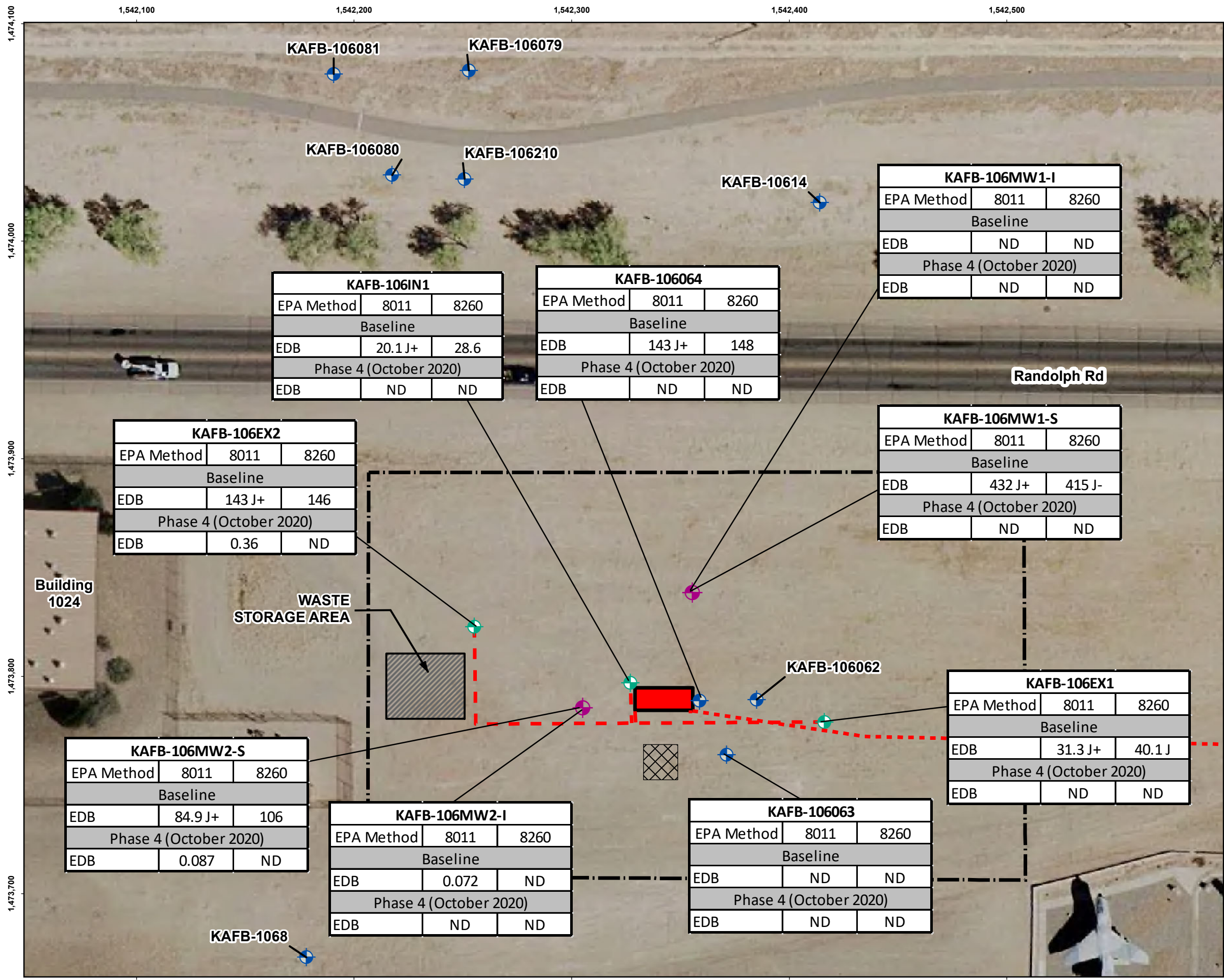

Legend

- Existing Monitoring Well
 - Pilot Test Injection/Extraction Well
 - Pilot Test Monitoring Well
 - Construction Fence
 - Pilot Test Trench Location for Water Pipe and Subsurface Electrical
 - Pilot Test System Location
 - Electrical Service Line
 - Storage Shed
- EPA = United States Environmental Protection Agency
 KAFB = Kirtland Air Force Base
 ND = Not Detected
- Units are in micrograms per liter.

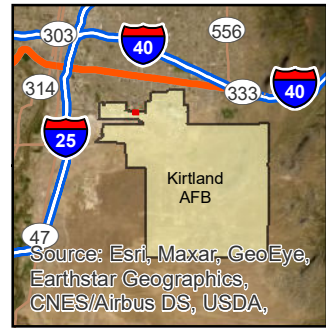

SITE LOCATION

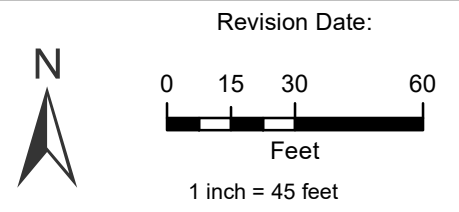

ETHYLENE DIBROMIDE IN SITU BIODEGRADATION
 PILOT TEST REPORT
 KIRTLAND AIR FORCE BASE, NEW MEXICO

FIGURE 8

EDB CONCENTRATIONS FOR BASELINE AND
 PHASE 4 SAMPLING EVENTS

KAFB-106IN1		
EPA Method	8011	8260
Baseline		
EDB	20.1 J+	28.6
Phase 4 (October 2020)		
EDB	ND	ND

KAFB-106064		
EPA Method	8011	8260
Baseline		
EDB	143 J+	148
Phase 4 (October 2020)		
EDB	ND	ND

KAFB-106MW1-I		
EPA Method	8011	8260
Baseline		
EDB	ND	ND
Phase 4 (October 2020)		
EDB	ND	ND

KAFB-106EX2		
EPA Method	8011	8260
Baseline		
EDB	143 J+	146
Phase 4 (October 2020)		
EDB	0.36	ND

KAFB-106MW1-S		
EPA Method	8011	8260
Baseline		
EDB	432 J+	415 J-
Phase 4 (October 2020)		
EDB	ND	ND

KAFB-106MW2-S		
EPA Method	8011	8260
Baseline		
EDB	84.9 J+	106
Phase 4 (October 2020)		
EDB	0.087	ND

KAFB-106MW2-I		
EPA Method	8011	8260
Baseline		
EDB	0.072	ND
Phase 4 (October 2020)		
EDB	ND	ND

KAFB-106063		
EPA Method	8011	8260
Baseline		
EDB	ND	ND
Phase 4 (October 2020)		
EDB	ND	ND

KAFB-106EX1		
EPA Method	8011	8260
Baseline		
EDB	31.3 J+	40.1 J
Phase 4 (October 2020)		
EDB	ND	ND

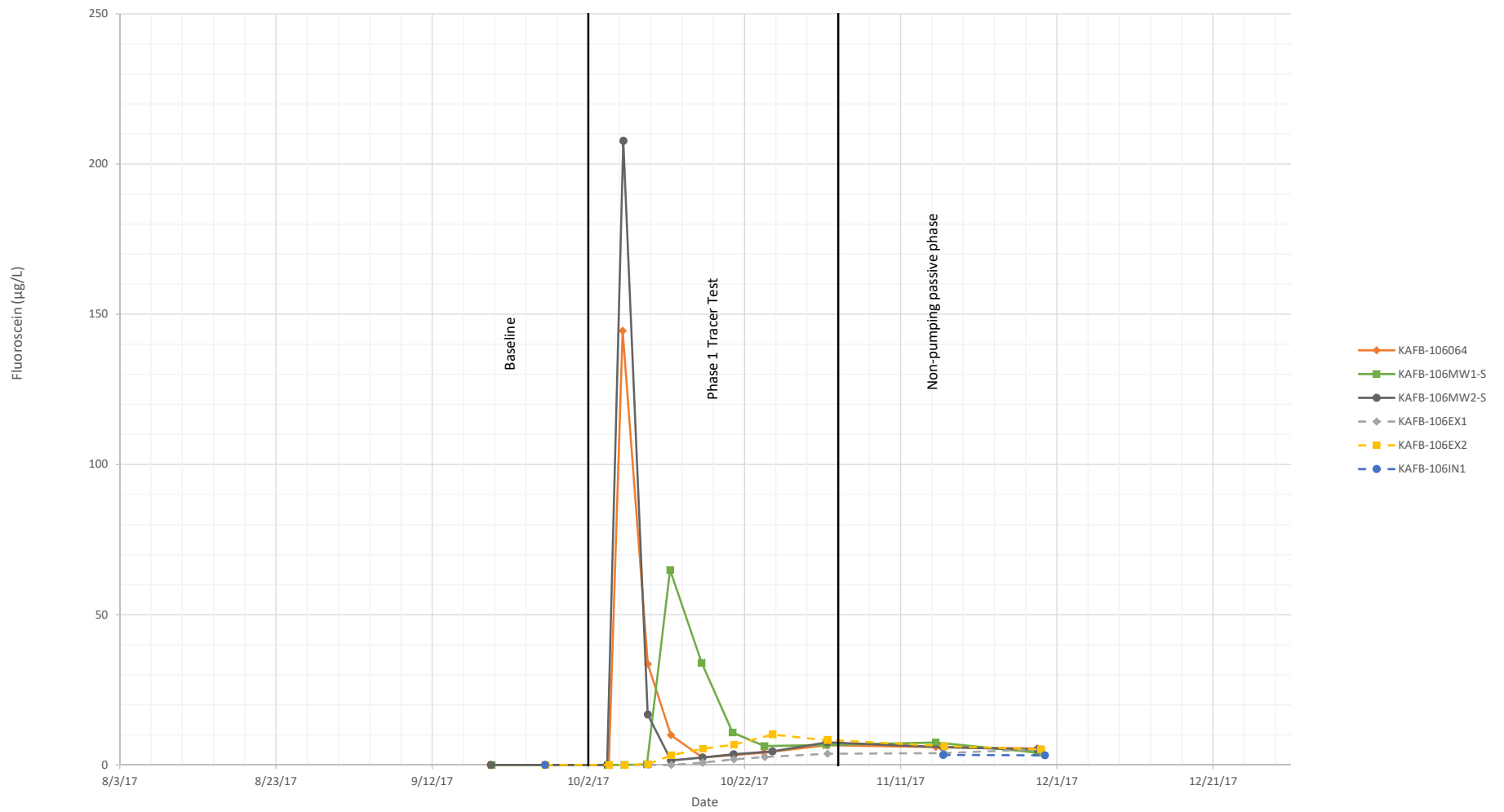

 APTIM Aptim Federal Services, LLC	FIGURE 9
	FLUOROSCEIN CONCENTRATIONS – SHALLOW WELLS

KIRTLAND AIR FORCE BASE
NEW MEXICO

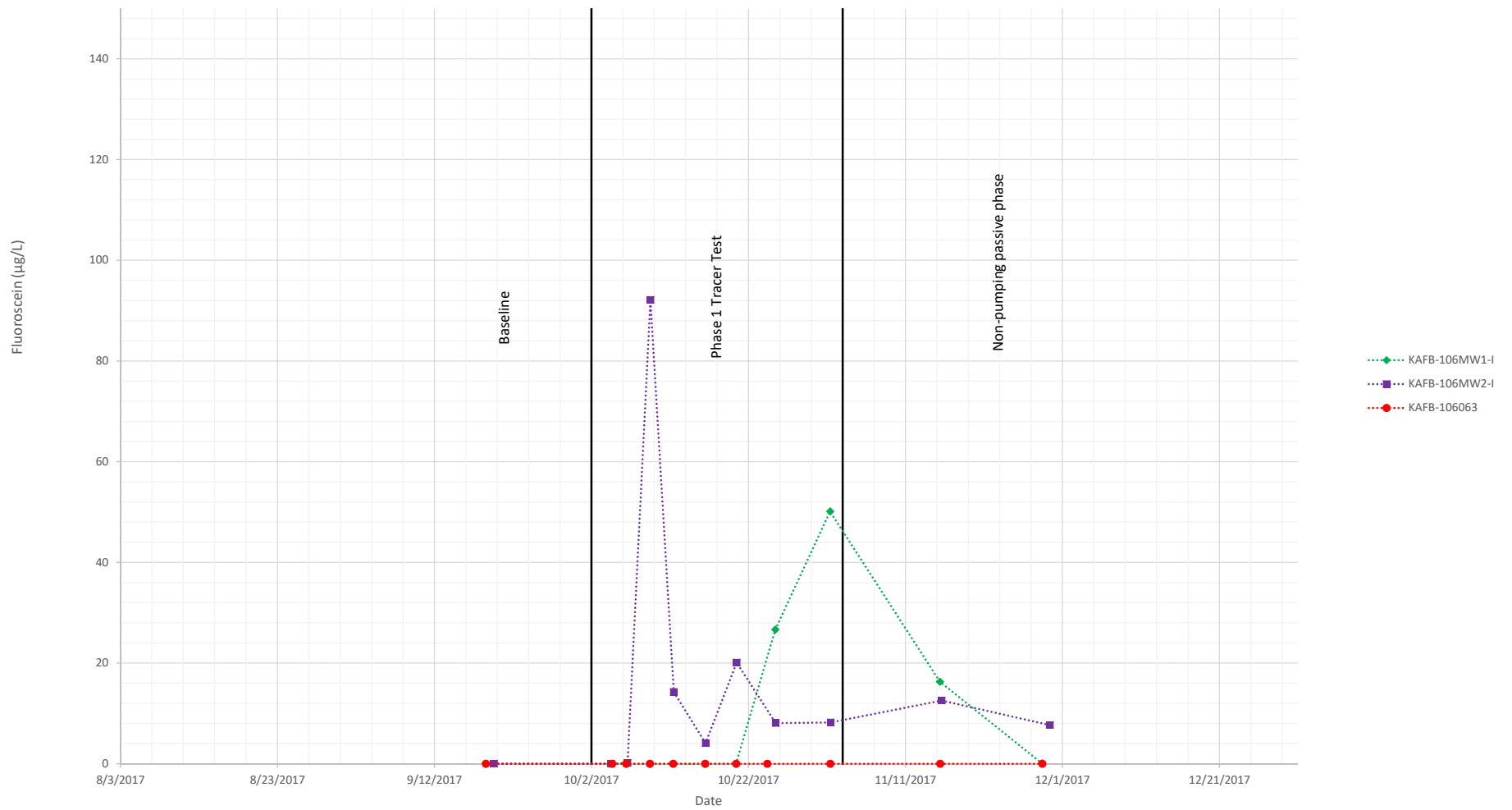

 APTIM Aptim Federal Services, LLC	FIGURE 10
	FLUOROSCEIN CONCENTRATIONS – INTERMEDIATE WELLS

KIRTLAND AIR FORCE BASE
NEW MEXICO

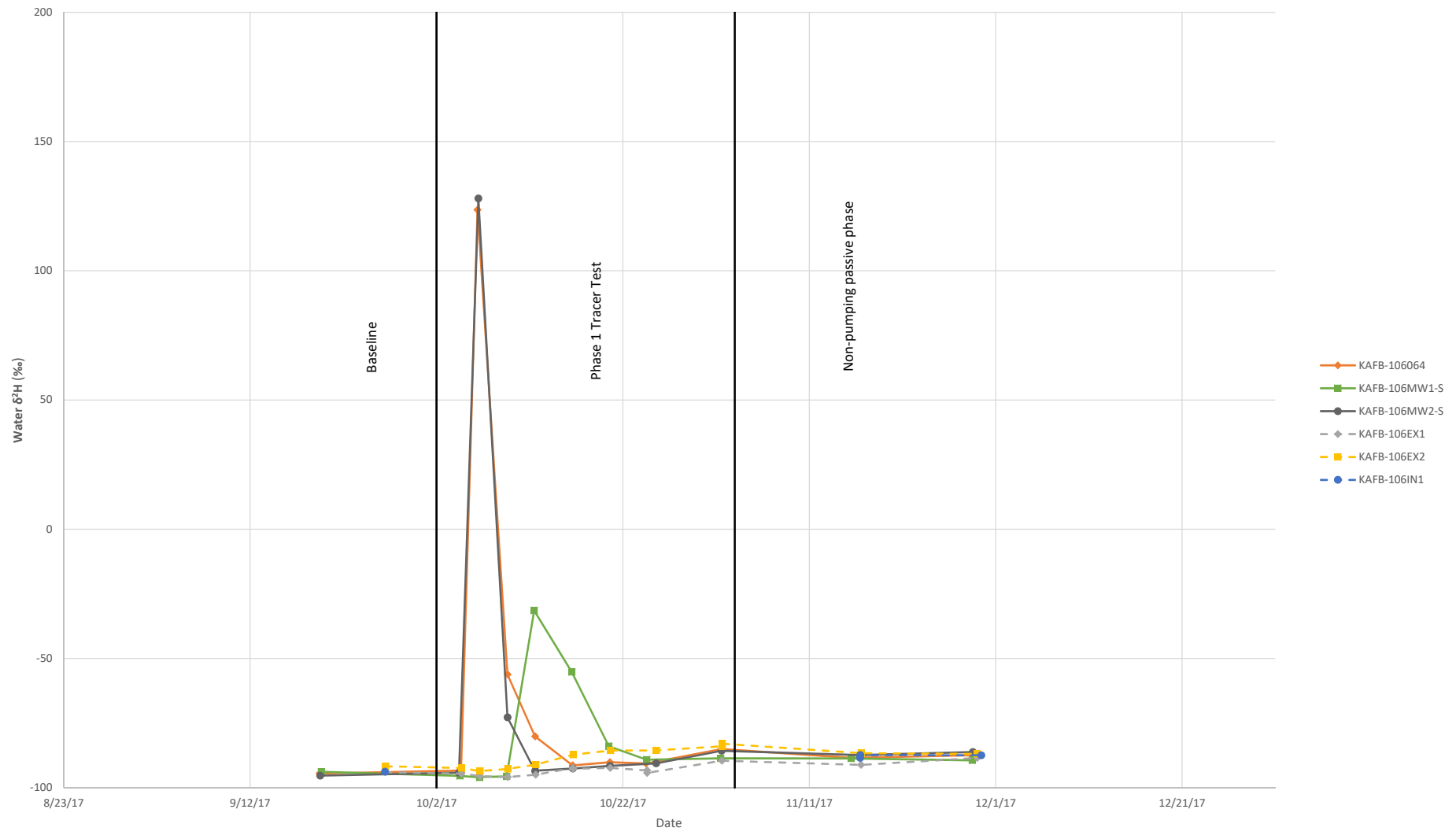

 Aptim Federal Services, LLC	FIGURE 11
	WATER Δ²H - SHALLOW WELLS

KIRTLAND AIR FORCE BASE
NEW MEXICO

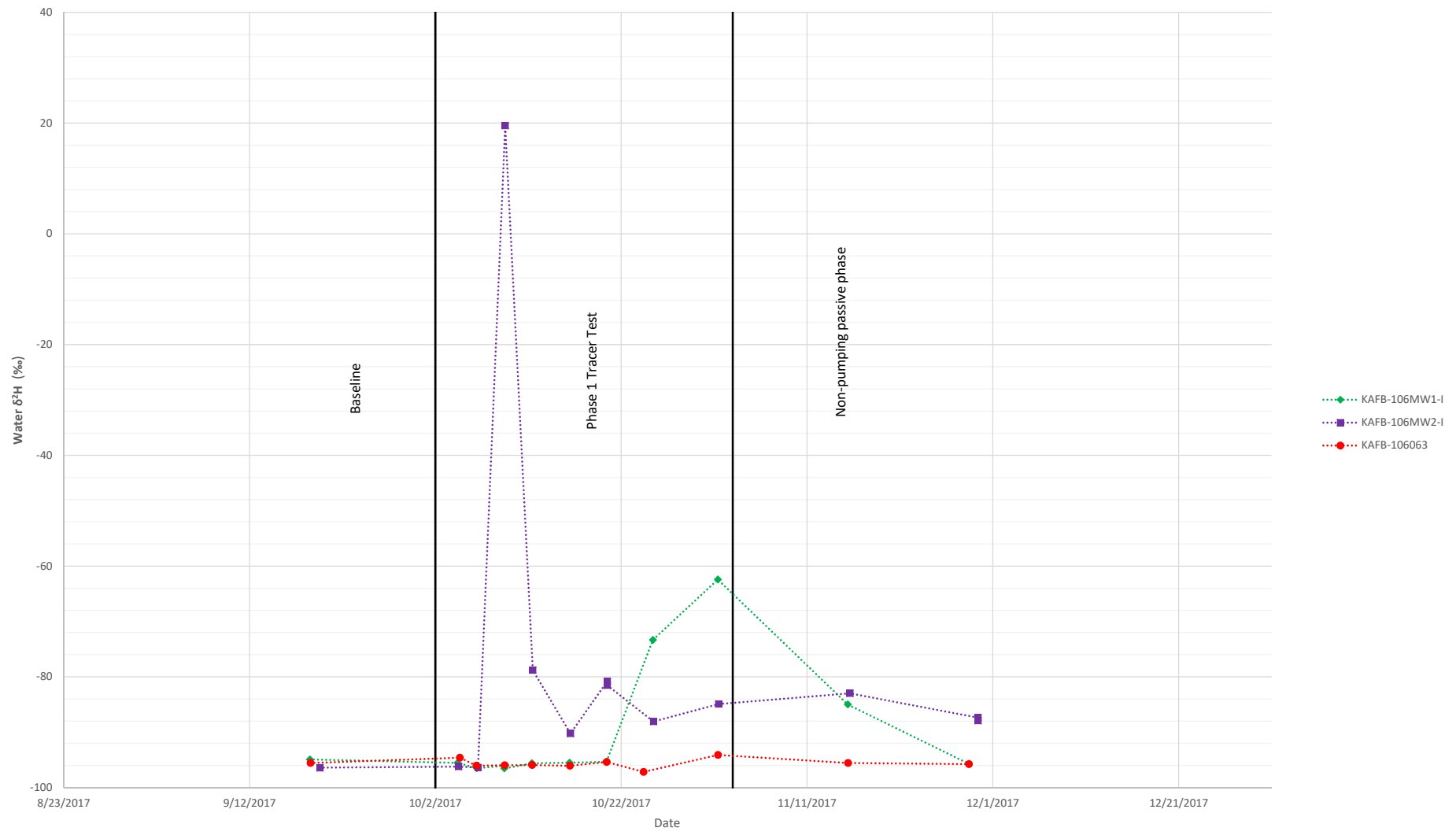

 Aptim Federal Services, LLC	FIGURE 12
	WATER Δ²H – INTERMEDIATE WELLS

KIRTLAND AIR FORCE BASE
NEW MEXICO

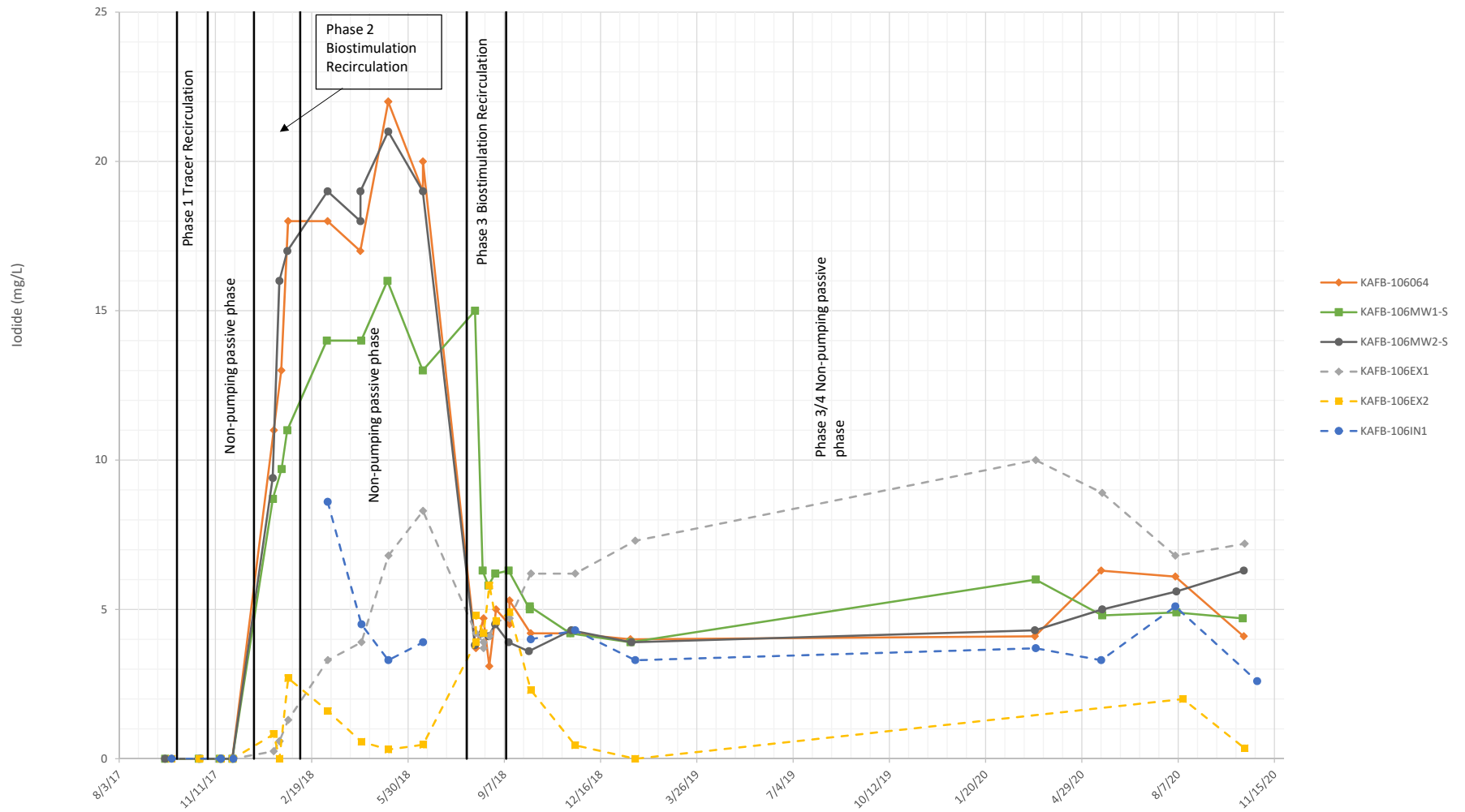

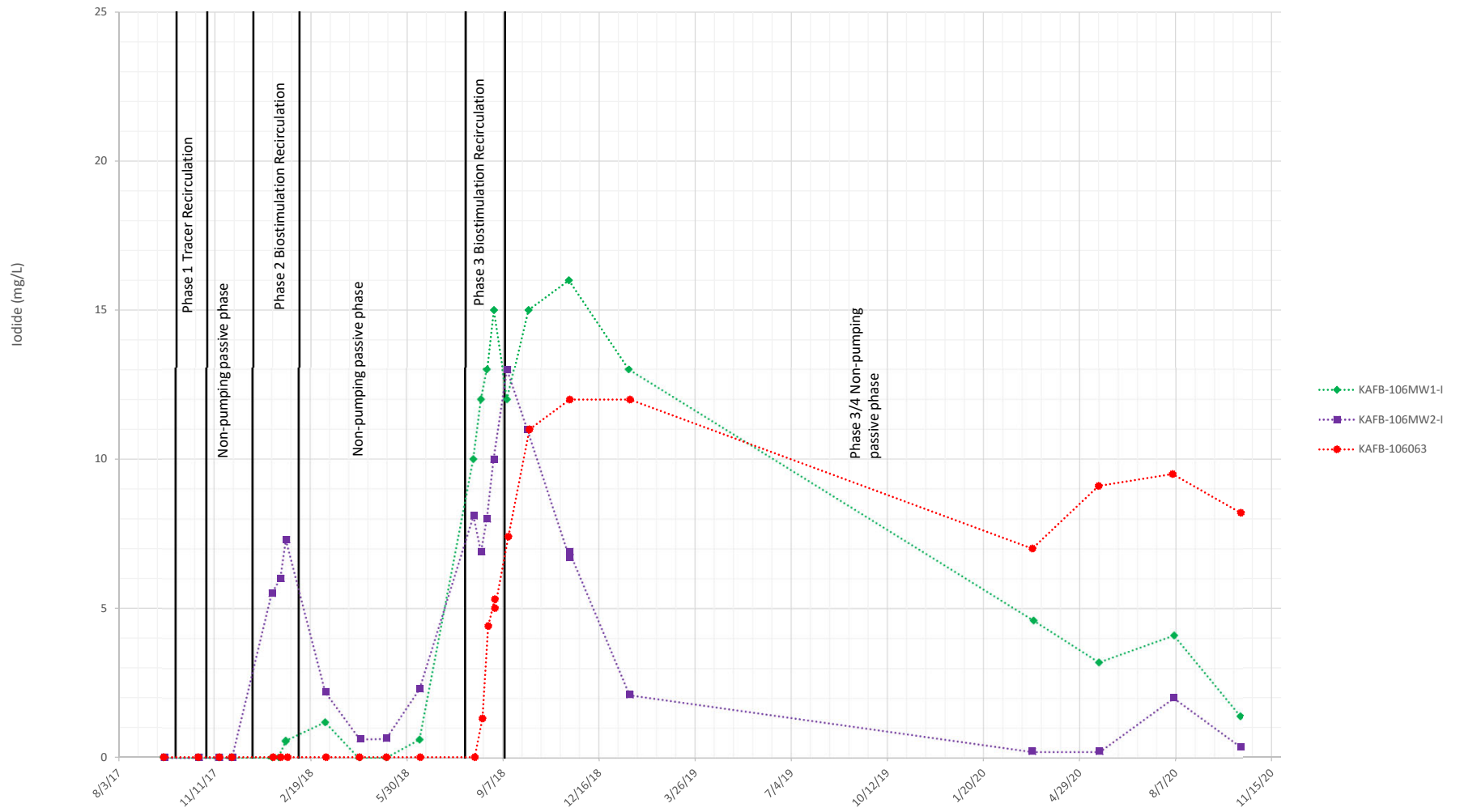

 APTIM Aptim Federal Services, LLC	FIGURE 13
	IODIDE CONCENTRATIONS - SHALLOW WELLS

KIRTLAND AIR FORCE BASE
NEW MEXICO



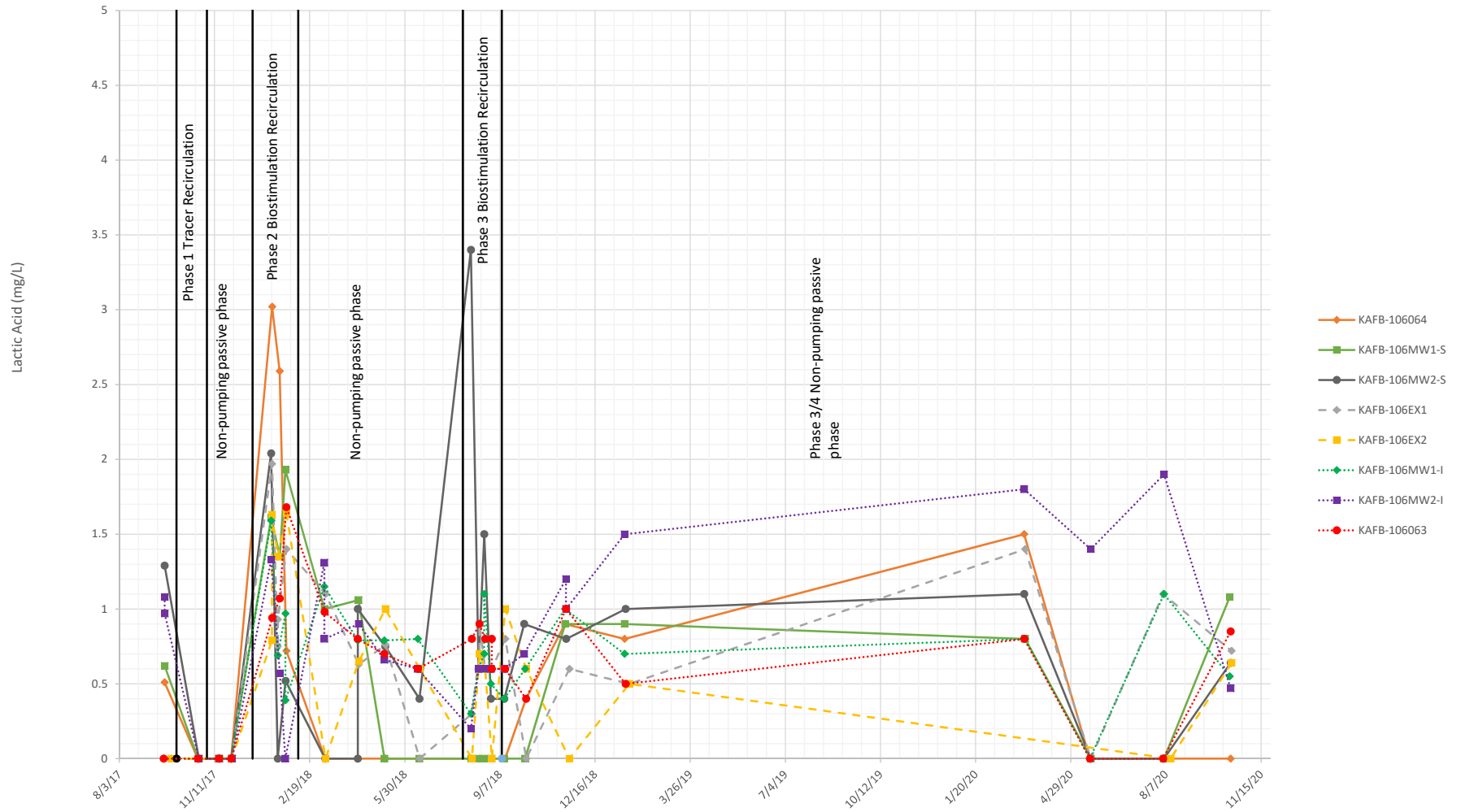

 Aptim Federal Services, LLC KIRTLAND AIR FORCE BASE NEW MEXICO	FIGURE 14
	IODIDE CONCENTRATIONS - INTERMEDIATE WELLS



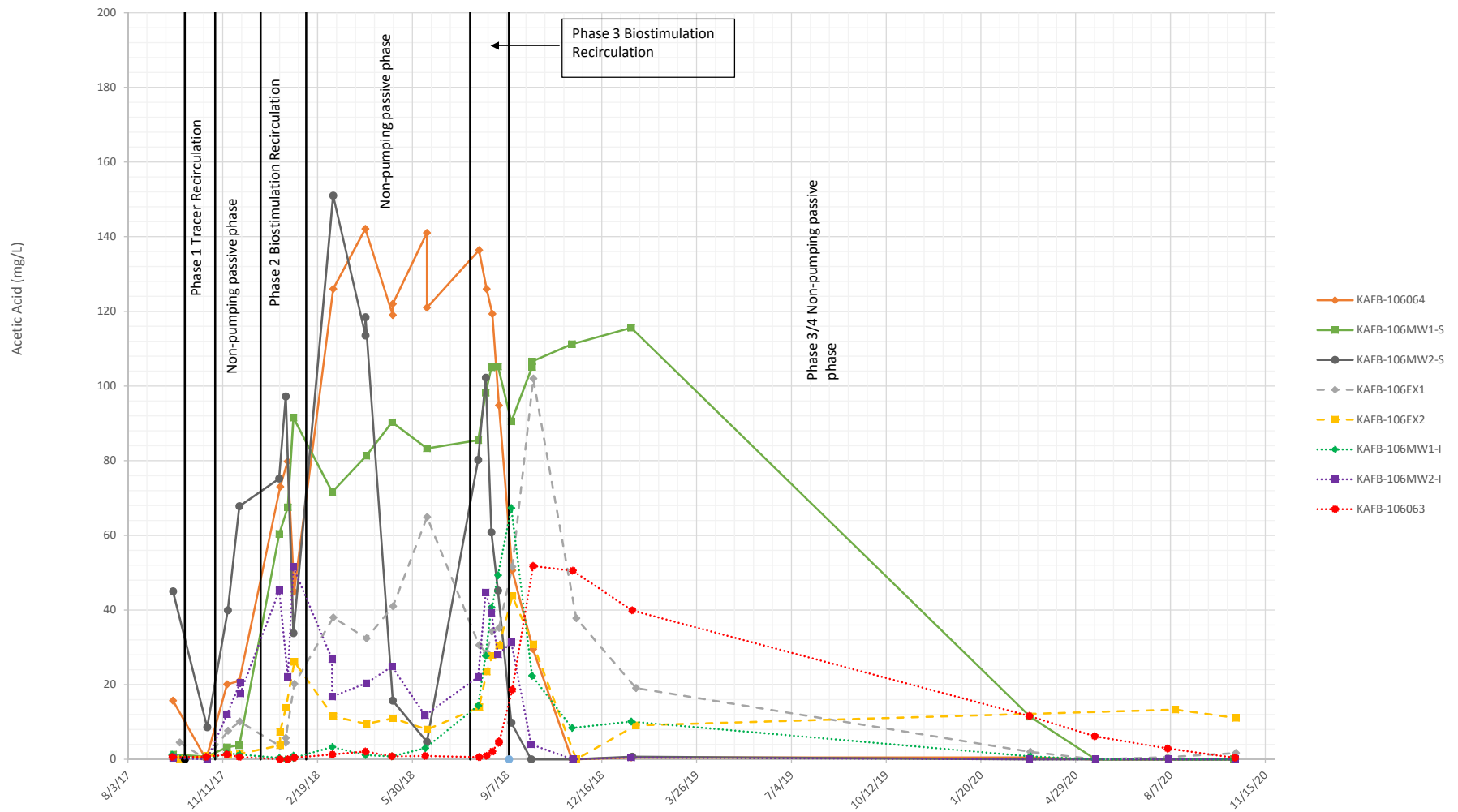

 APTIM Aptim Federal Services, LLC	FIGURE 15
	LACTIC ACID CONCENTRATIONS - ALL WELLS (EXCEPT 106IN1)

KIRTLAND AIR FORCE BASE
NEW MEXICO



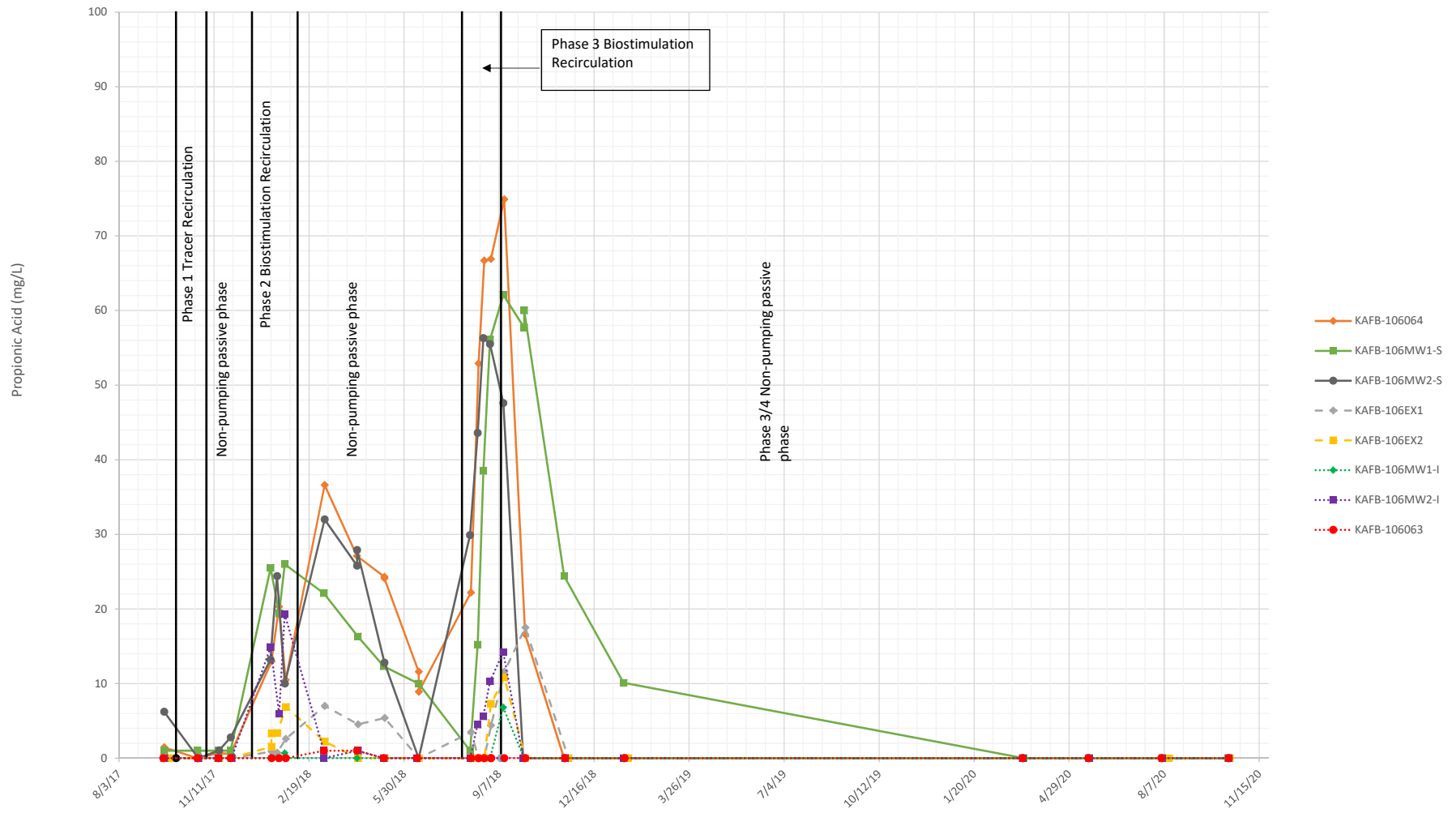

 Aptim Federal Services, LLC KIRTLAND AIR FORCE BASE NEW MEXICO	FIGURE 16
	ACETIC ACID CONCENTRATIONS - ALL WELLS (EXCEPT 106IN1)

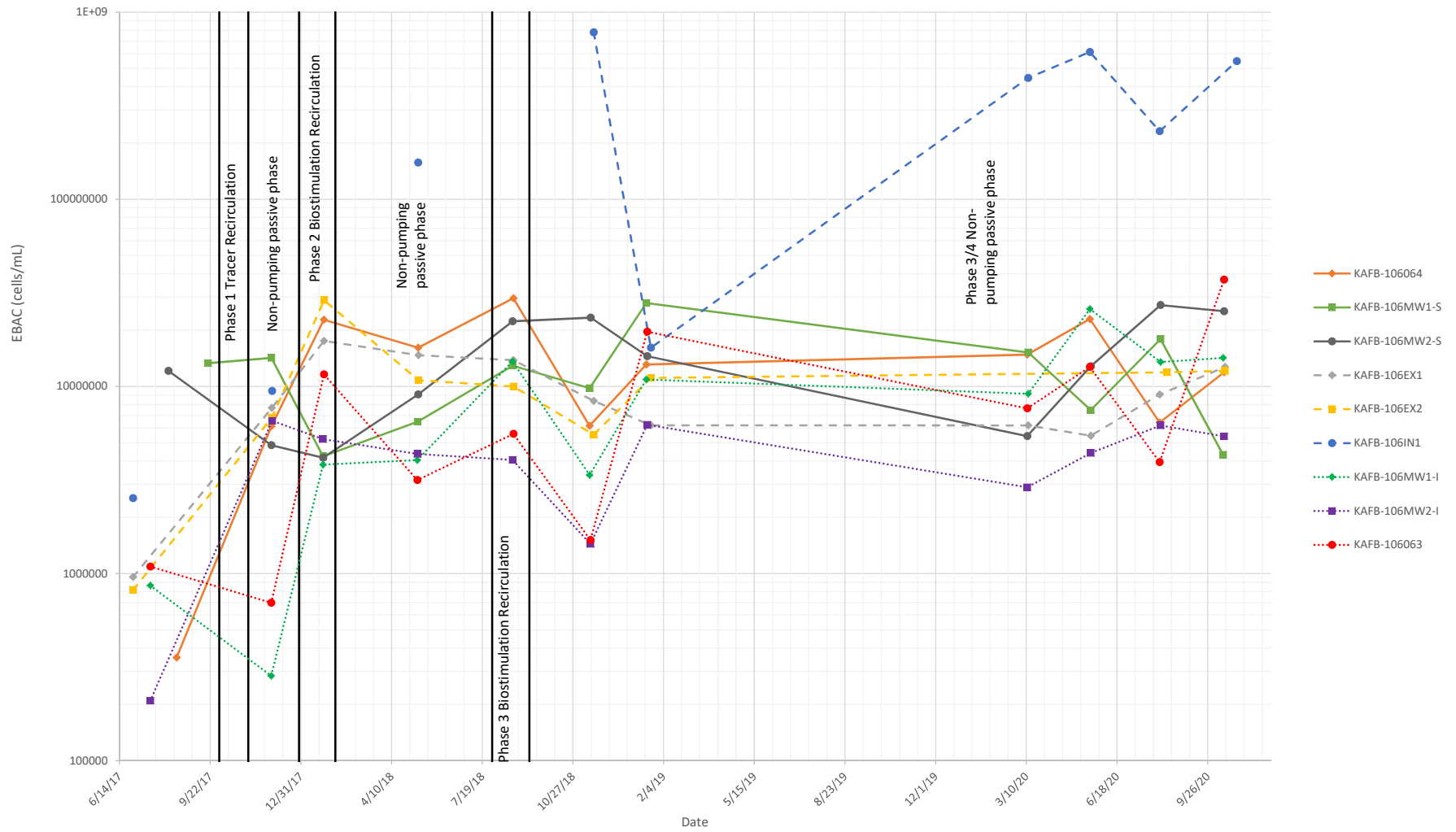

 APTIM Aptim Federal Services, LLC	FIGURE 17
	PROPIONIC ACID CONCENTRATIONS - ALL WELLS (EXCEPT 106IN1)

KIRTLAND AIR FORCE BASE
NEW MEXICO



 APTIM Aptim Federal Services, LLC	FIGURE 18
	EBAC CONCENTRATIONS - ALL WELLS

KIRTLAND AIR FORCE BASE
NEW MEXICO

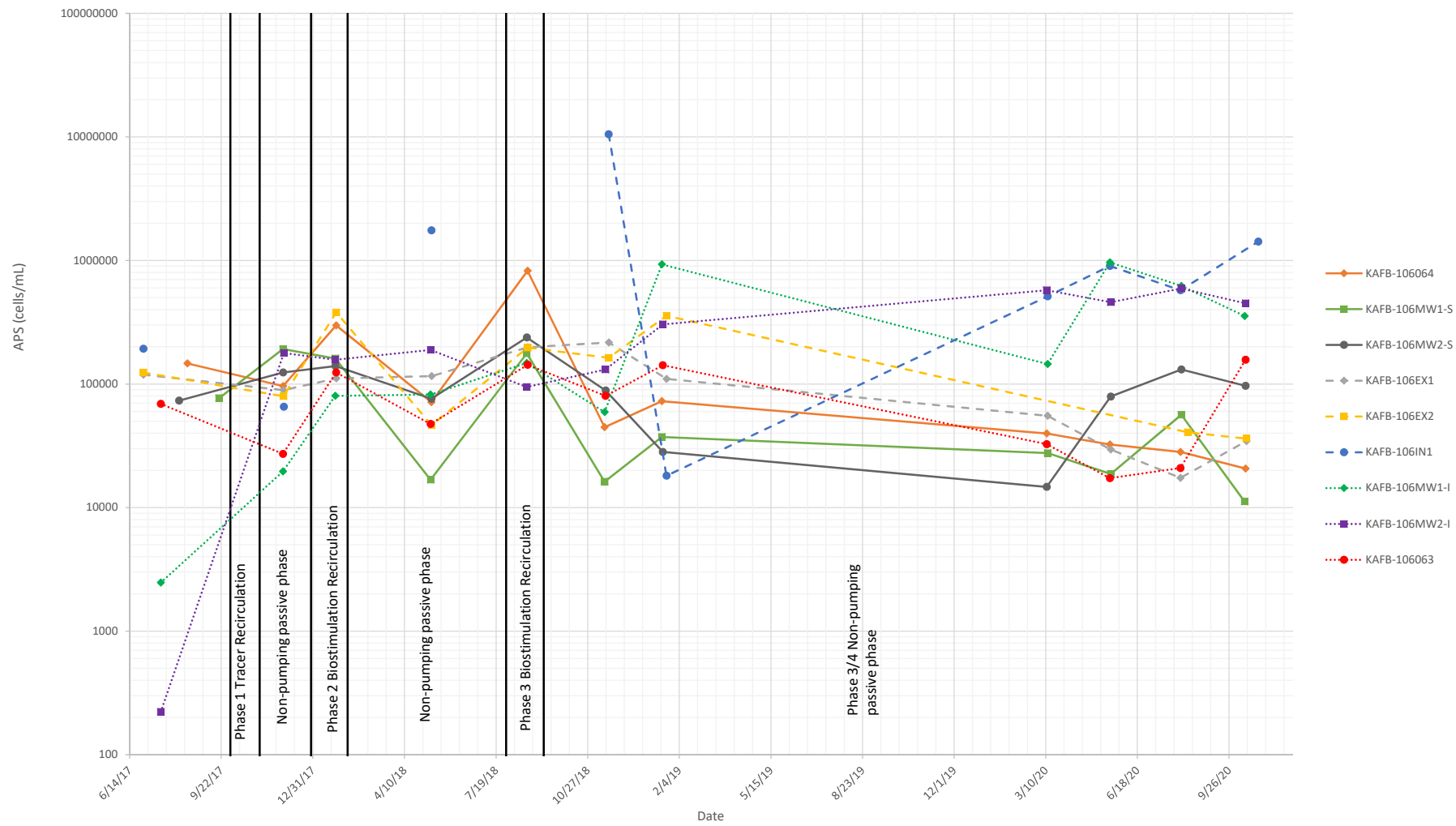

 Aptim Federal Services, LLC	FIGURE 19
	APS CONCENTRATIONS - ALL WELLS

KIRTLAND AIR FORCE BASE
NEW MEXICO

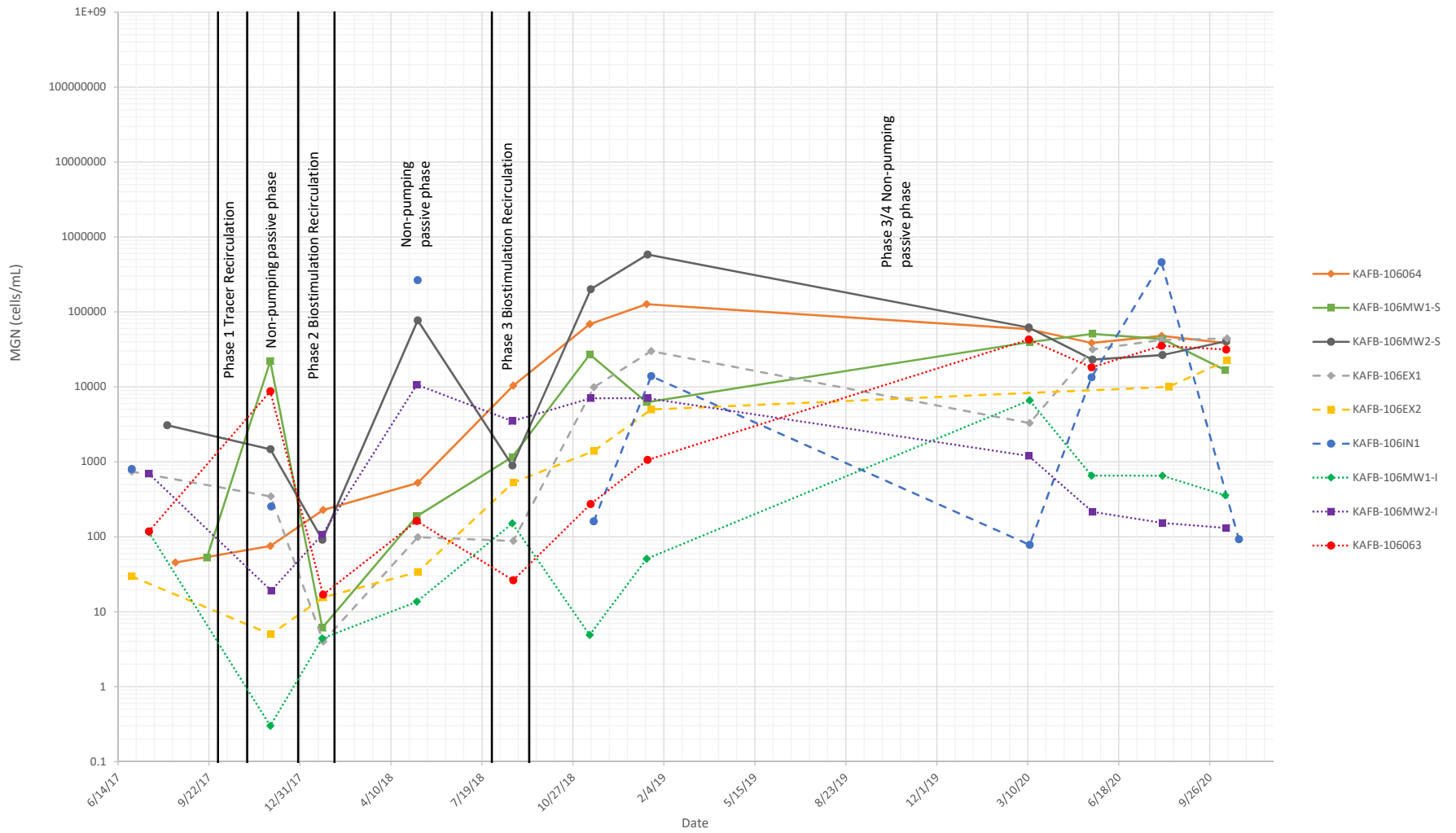

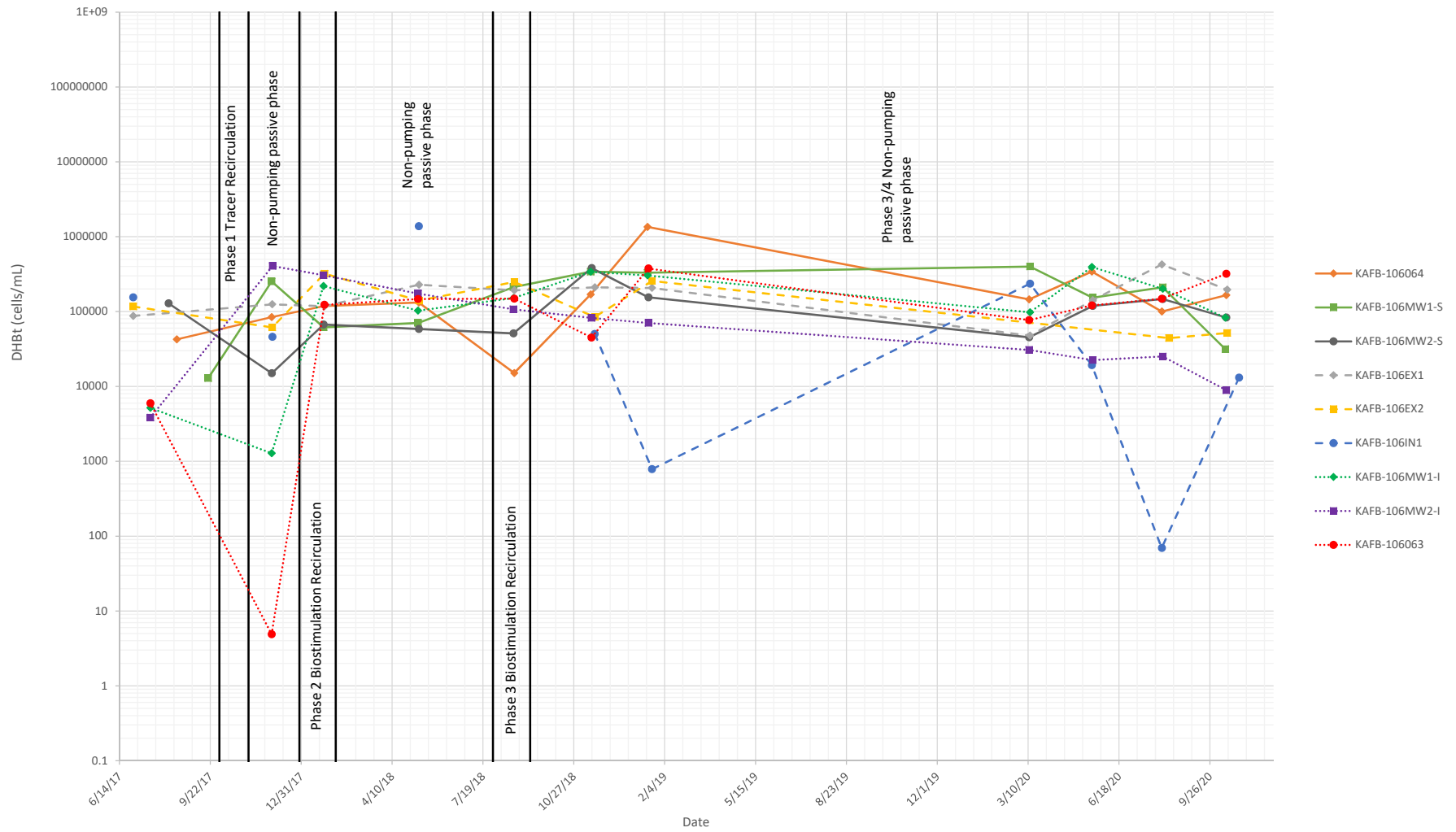

 Aptim Federal Services, LLC	FIGURE 21
	DHBt CONCENTRATIONS - ALL WELLS

KIRTLAND AIR FORCE BASE
NEW MEXICO

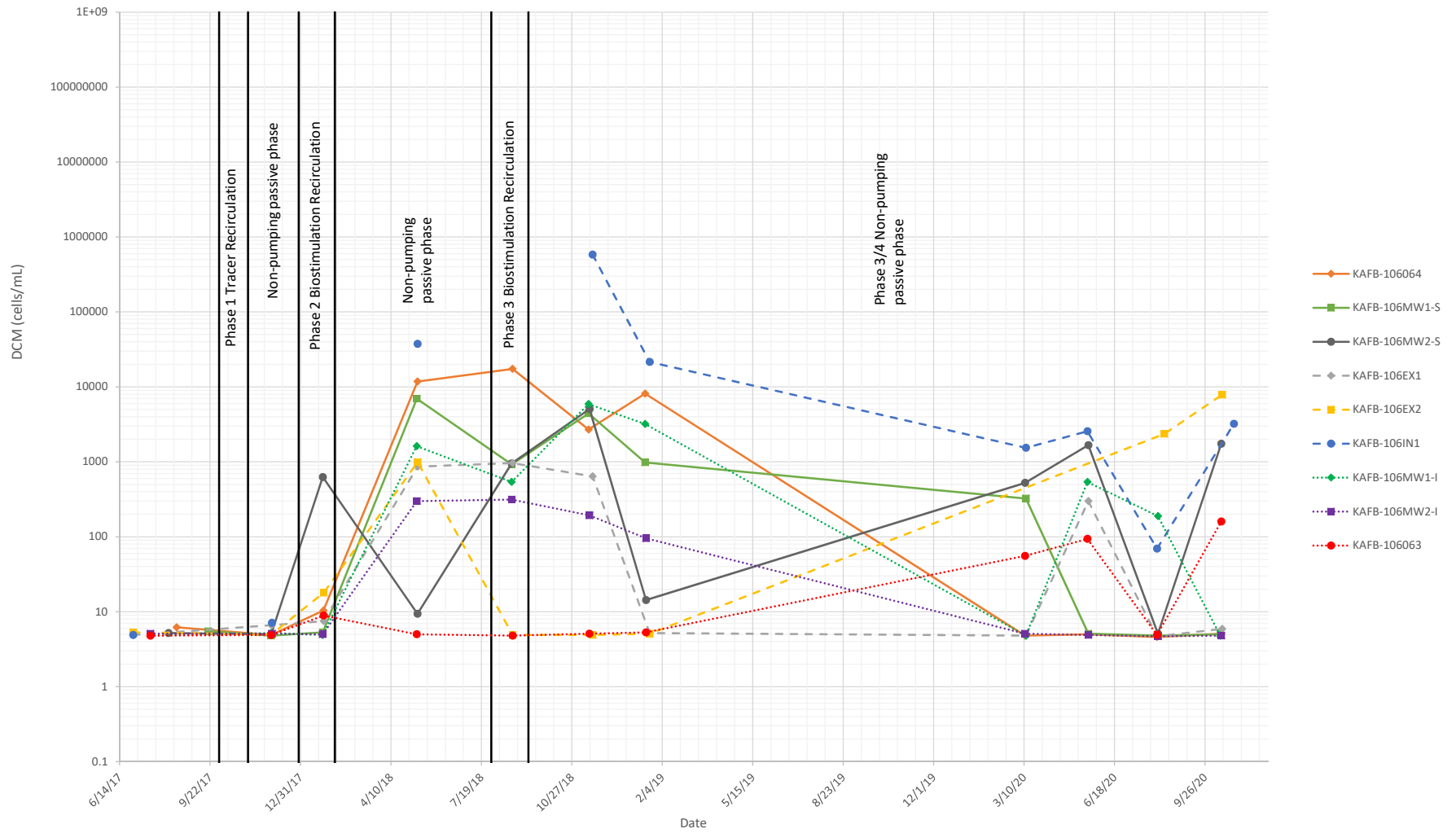

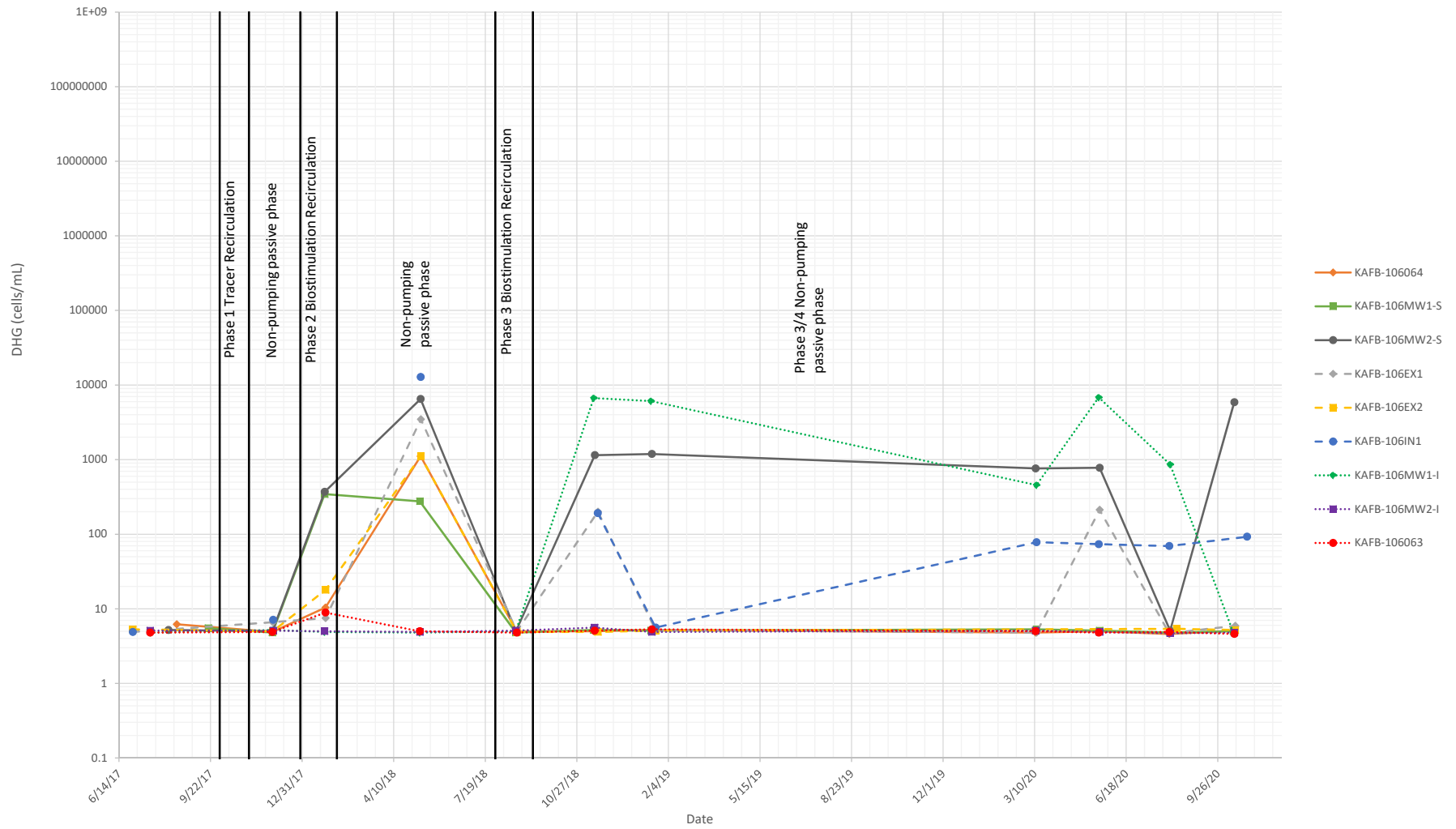

 APTIM Aptim Federal Services, LLC	FIGURE 22
	DCM CONCENTRATIONS - ALL WELLS

KIRTLAND AIR FORCE BASE
NEW MEXICO

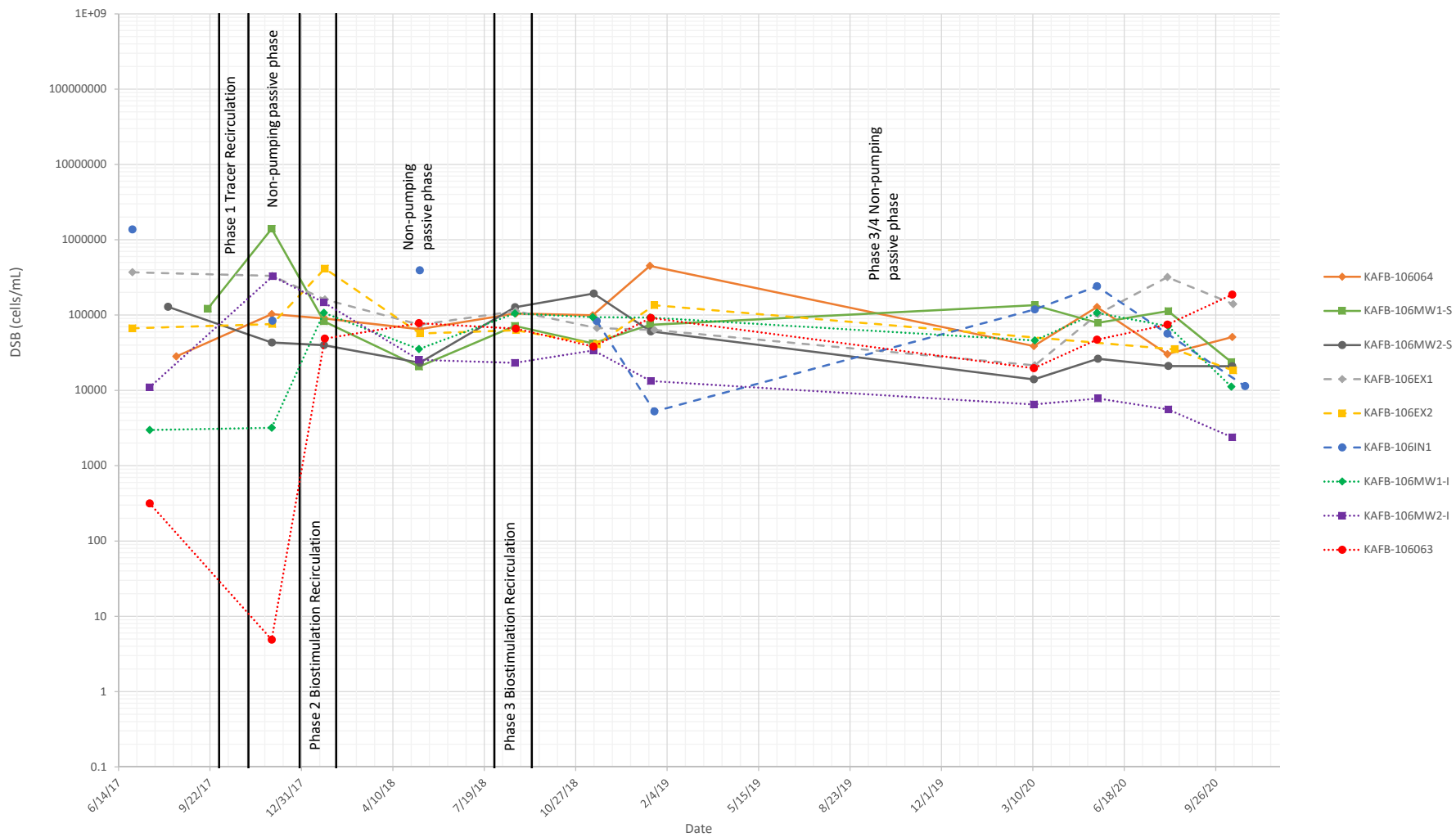

 Aptim Federal Services, LLC KIRTLAND AIR FORCE BASE NEW MEXICO	FIGURE 23
	DHG CONCENTRATIONS - ALL WELLS



 Aptim Federal Services, LLC KIRTLAND AIR FORCE BASE NEW MEXICO	FIGURE 24
	DSB CONCENTRATIONS - ALL WELLS

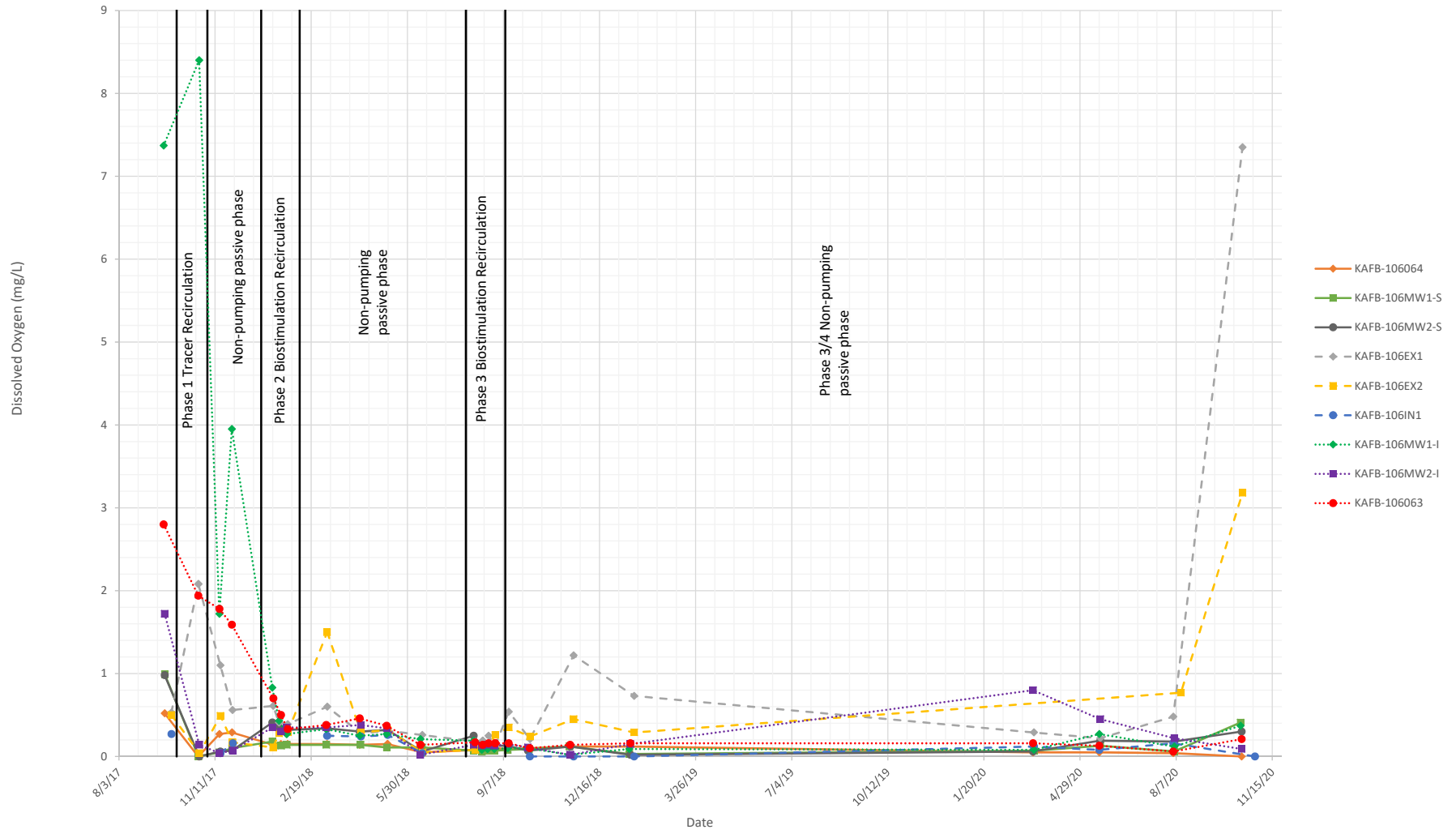

 APTIM Aptim Federal Services, LLC	FIGURE 25
	DISSOLVED OXYGEN - ALL WELLS

KIRTLAND AIR FORCE BASE
NEW MEXICO

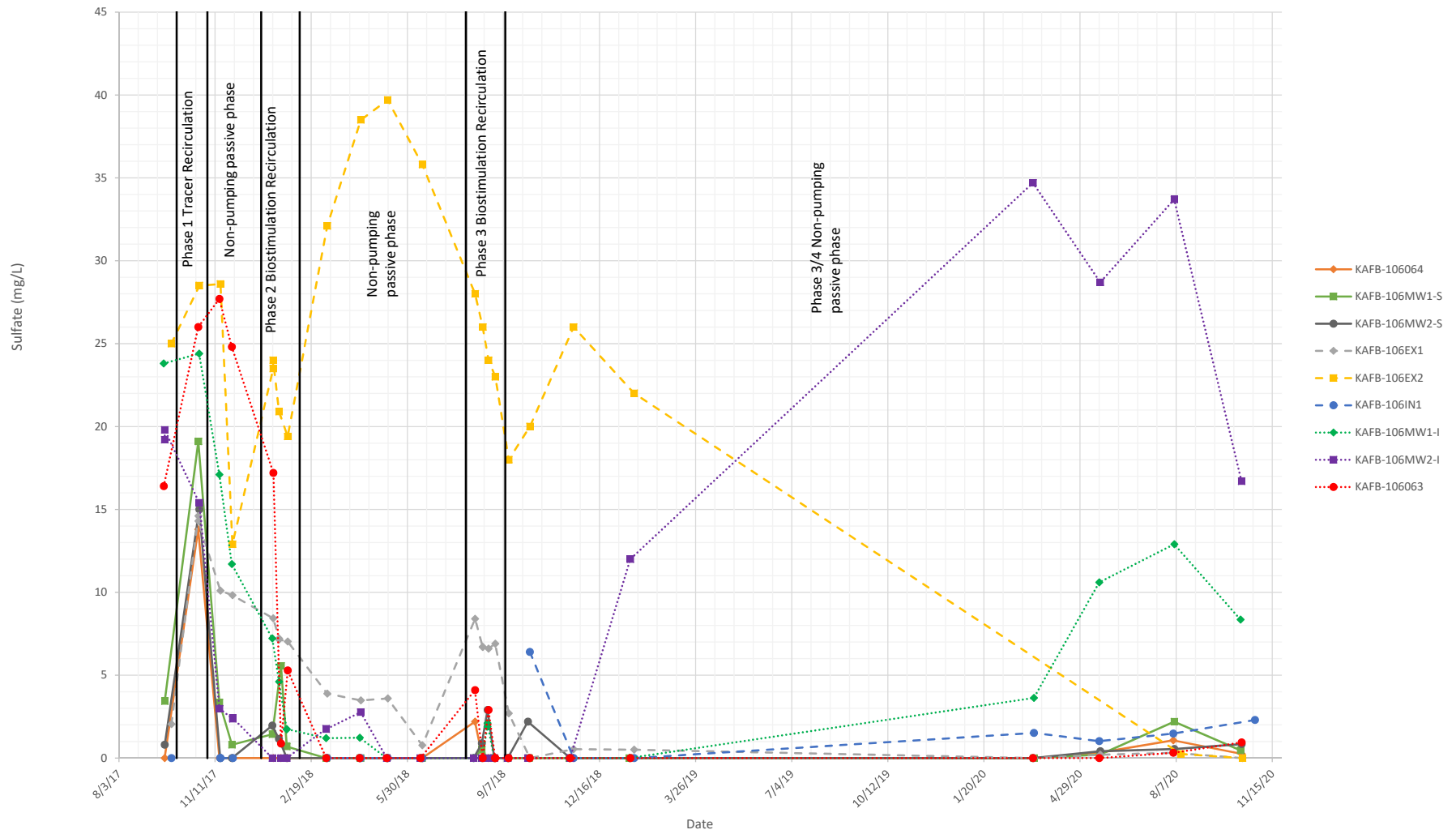

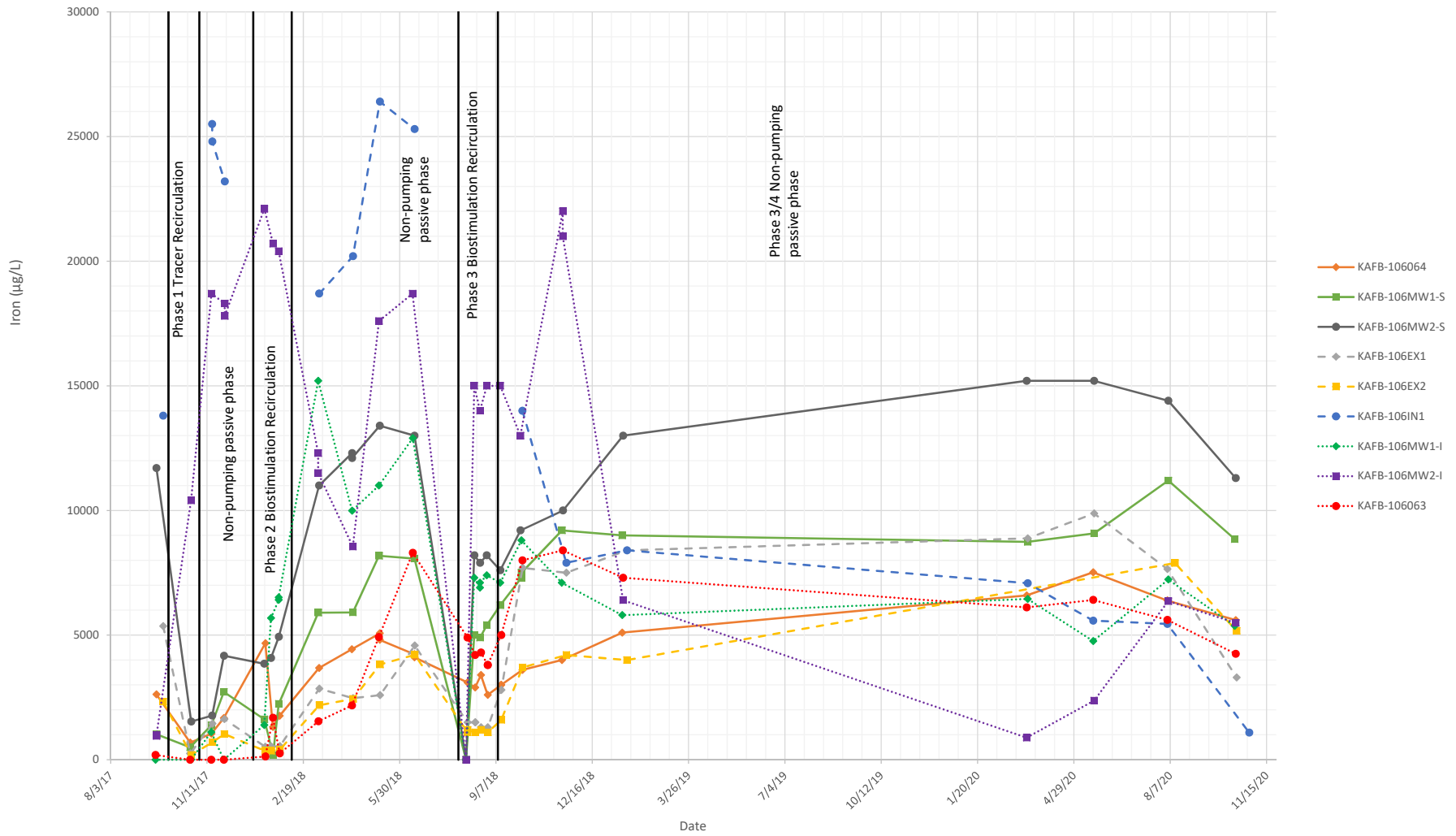

 APTIM Aptim Federal Services, LLC	FIGURE 27
	IRON (DISSOLVED) CONCENTRATIONS - ALL WELLS

KIRTLAND AIR FORCE BASE
NEW MEXICO

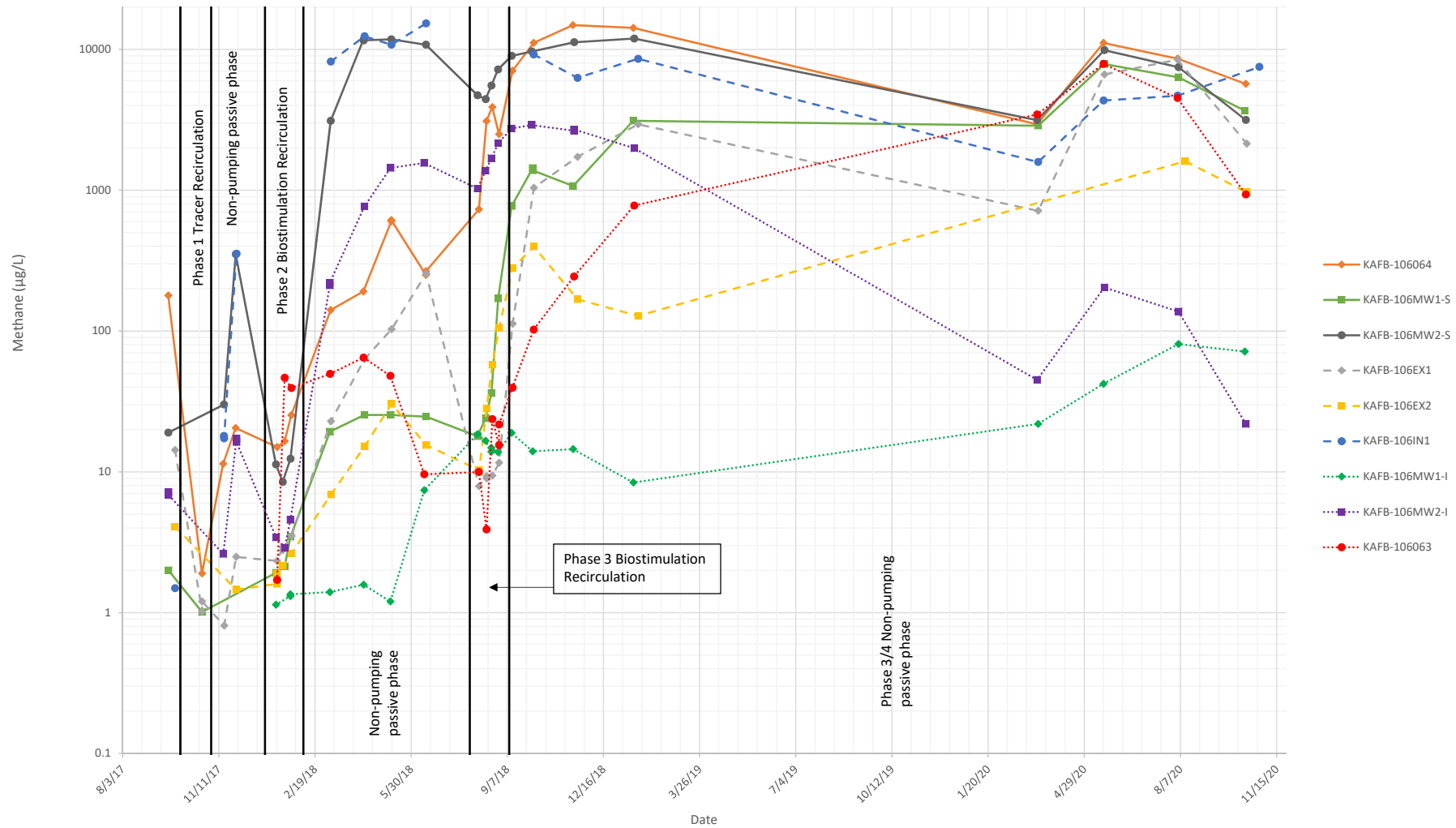

 APTIM Aptim Federal Services, LLC	FIGURE 28
	METHANE CONCENTRATIONS - ALL WELLS

KIRTLAND AIR FORCE BASE
NEW MEXICO

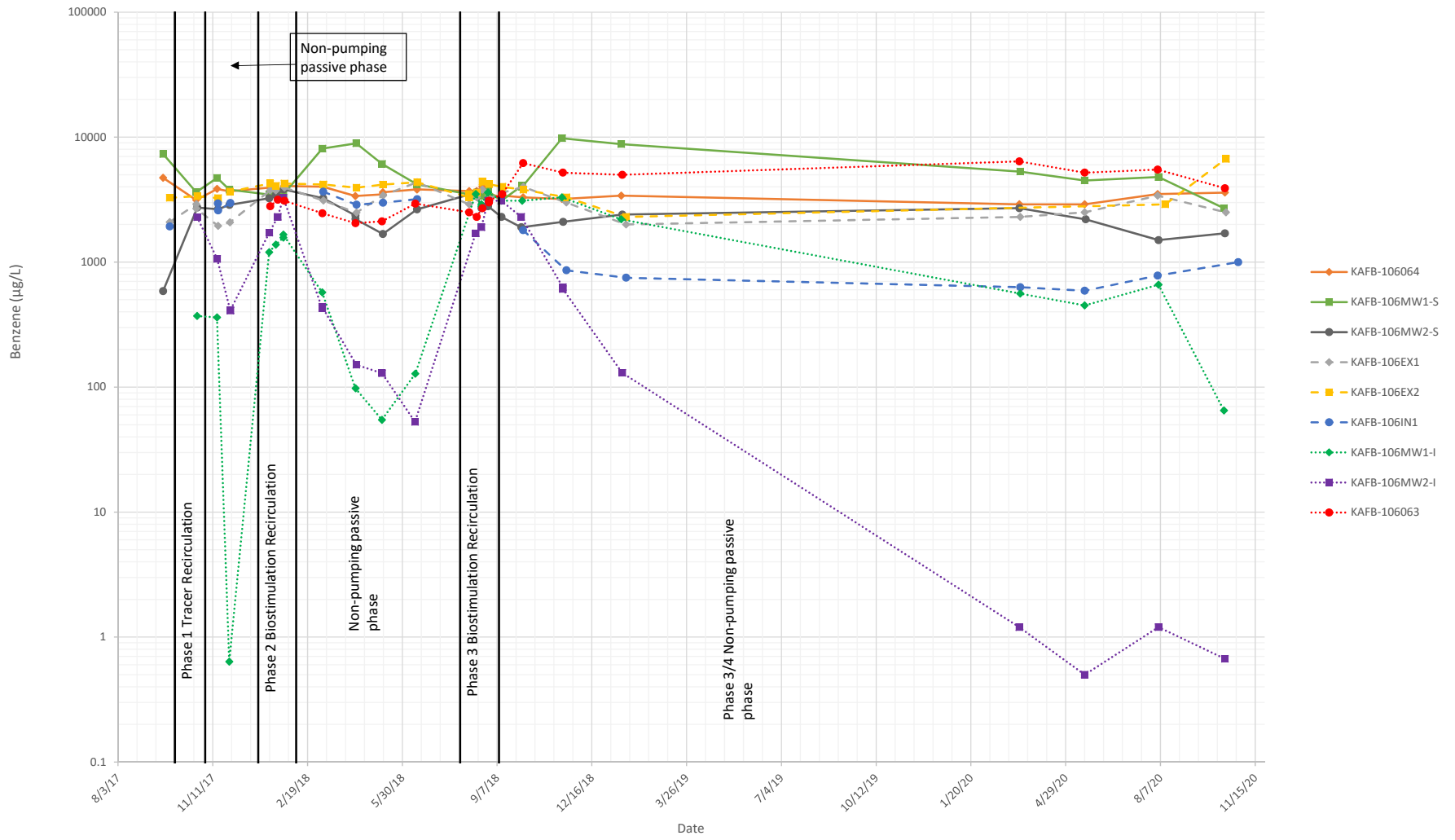

 APTIM Aptim Federal Services, LLC	FIGURE 29
	BENZENE CONCENTRATIONS - ALL WELLS

KIRTLAND AIR FORCE BASE
NEW MEXICO

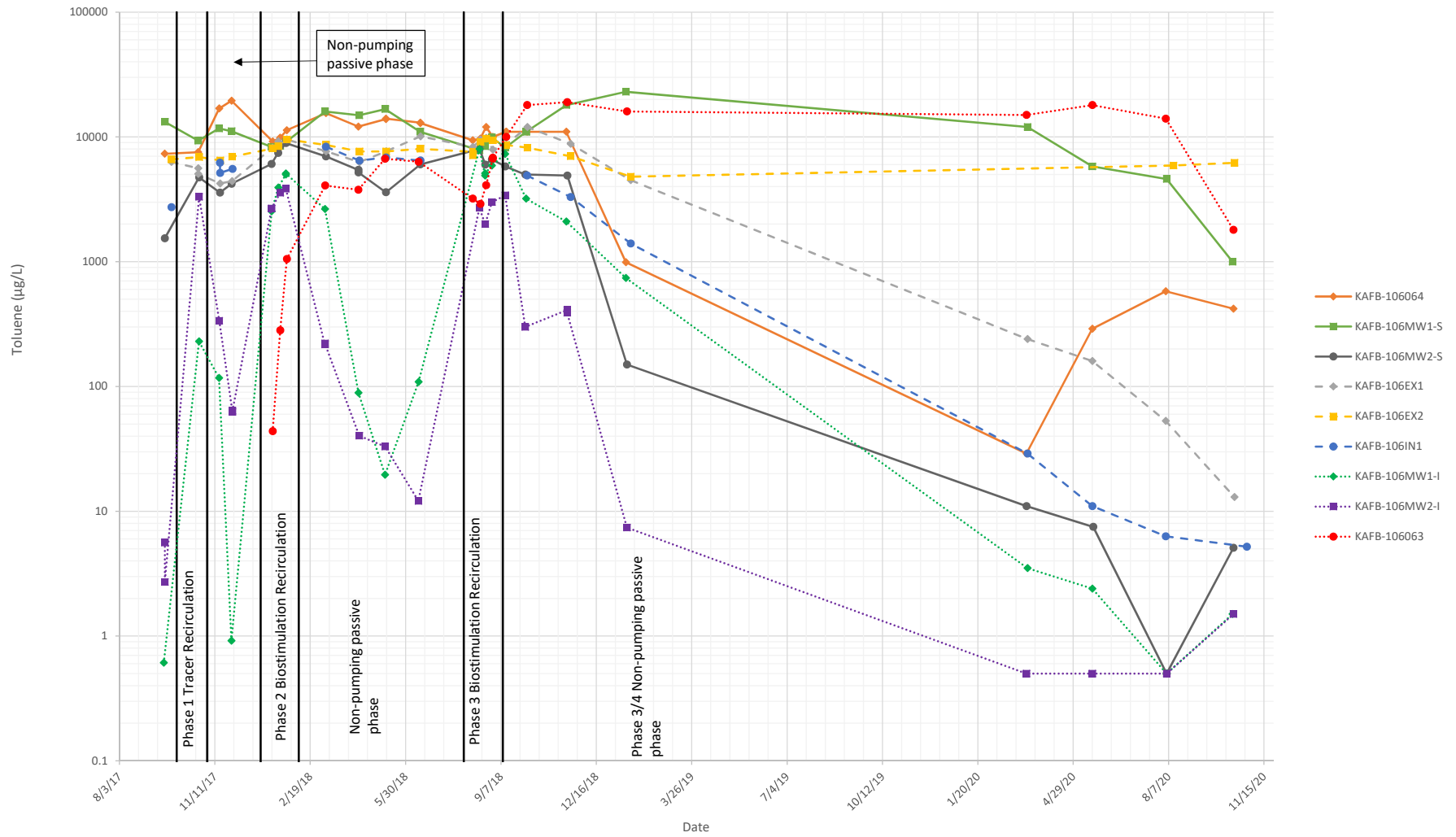

 APTIM Aptim Federal Services, LLC	FIGURE 30
	TOLUENE CONCENTRATIONS - ALL WELLS

KIRTLAND AIR FORCE BASE
NEW MEXICO

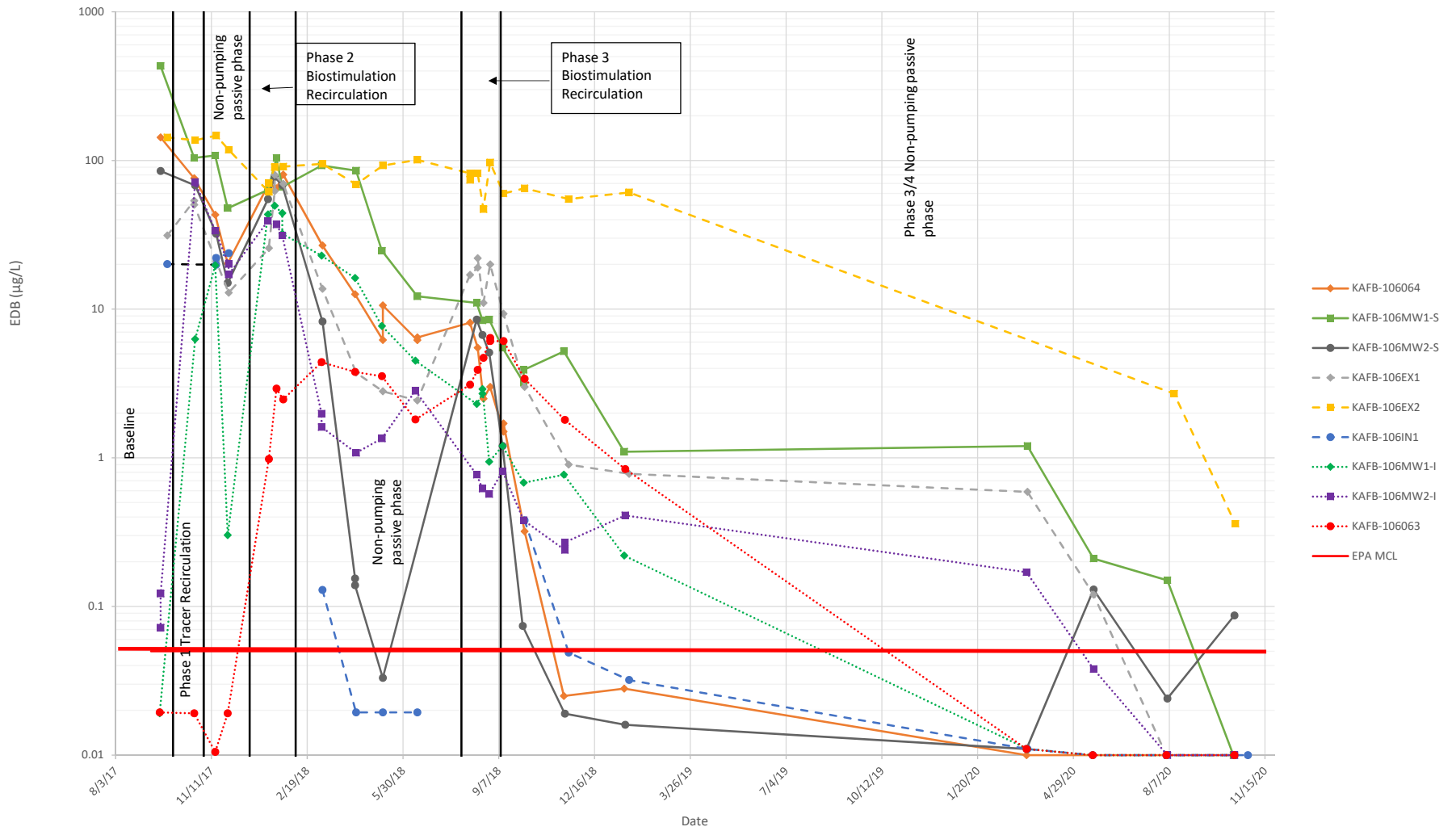

 APTIM Aptim Federal Services, LLC	FIGURE 31
	EDB CONCENTRATIONS - ALL WELLS

KIRTLAND AIR FORCE BASE
NEW MEXICO

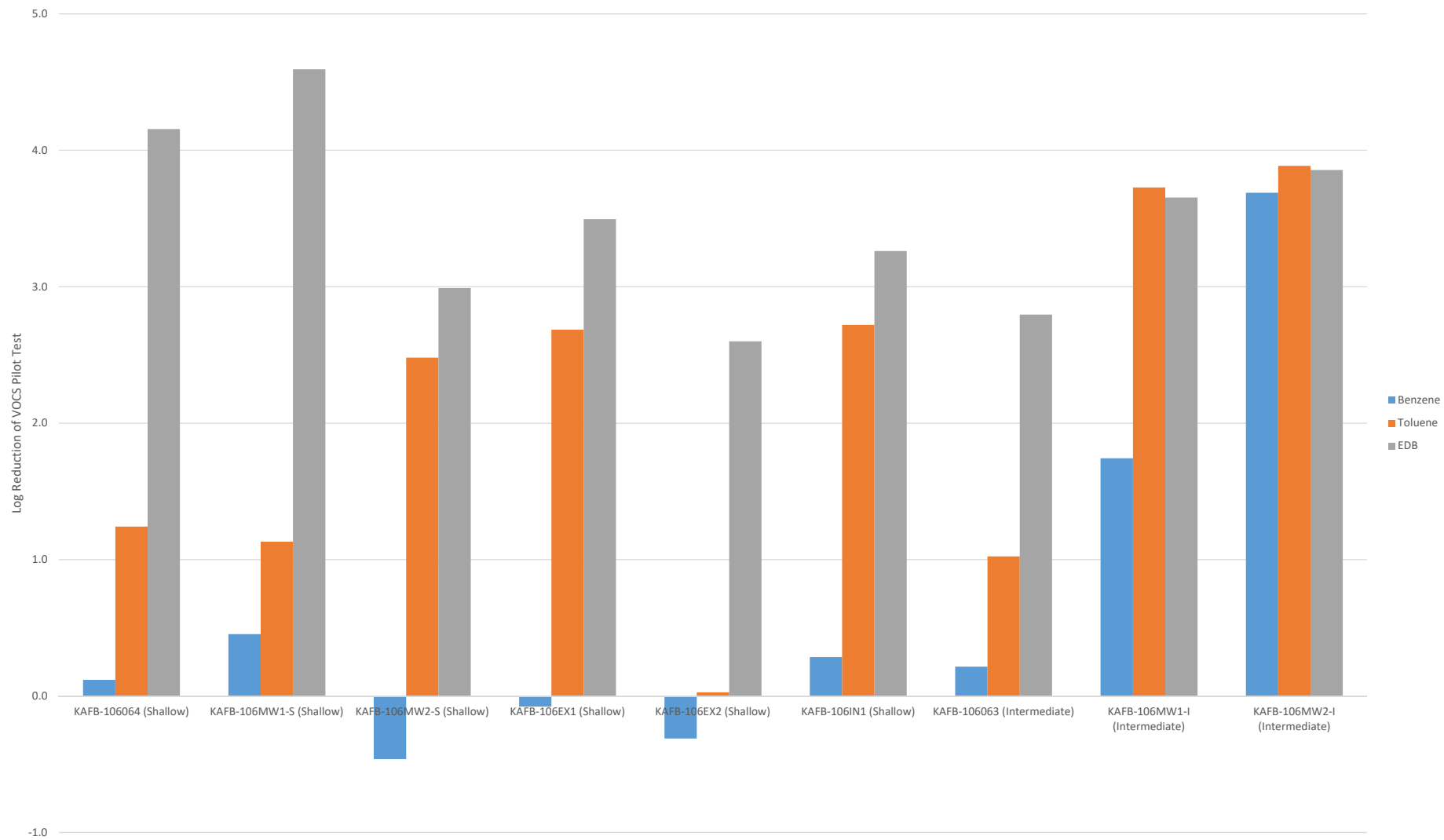

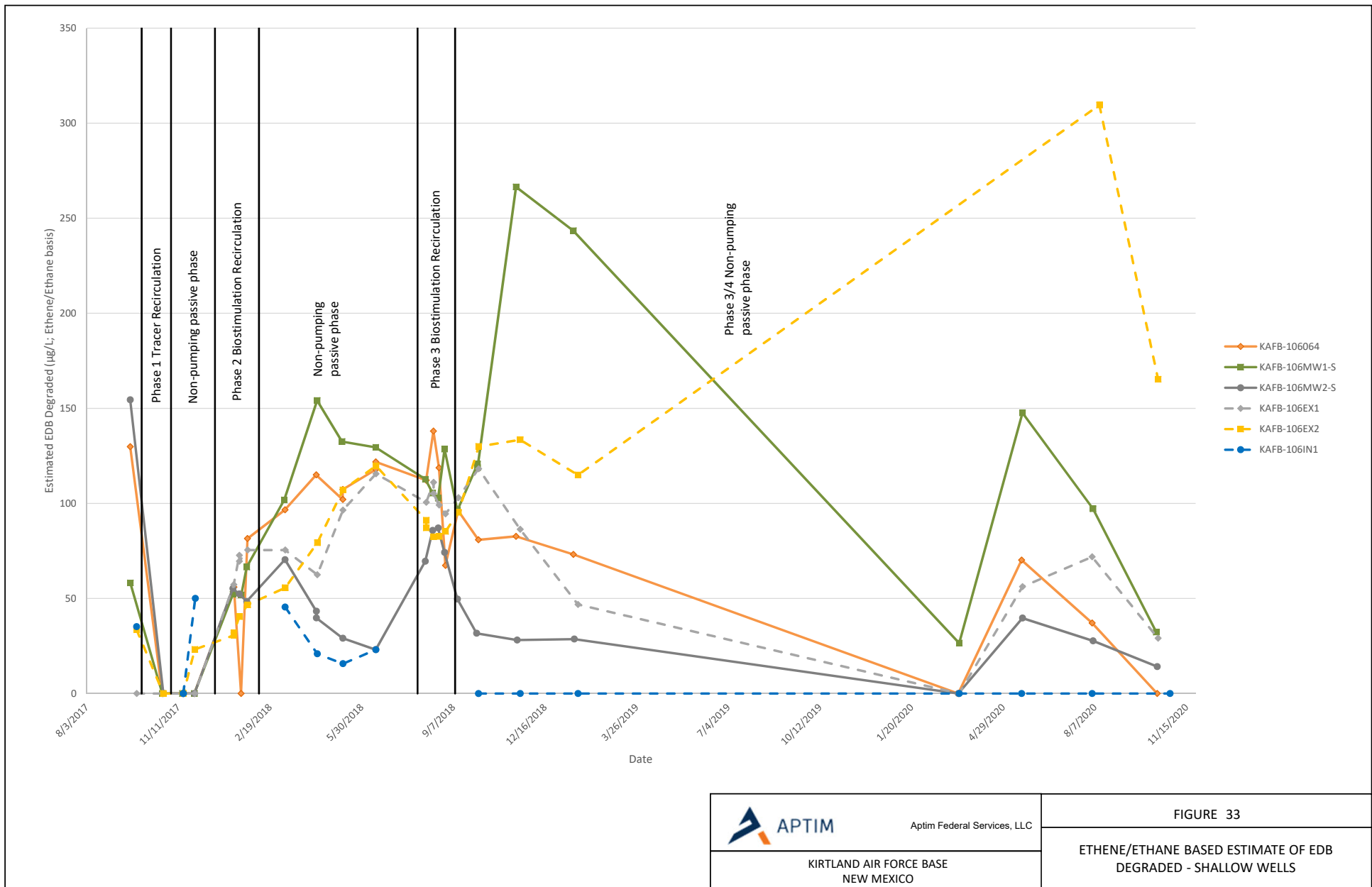

 APTIM Aptim Federal Services, LLC	FIGURE 32
	VOC REDUCTION - ALL WELLS

KIRTLAND AIR FORCE BASE
NEW MEXICO

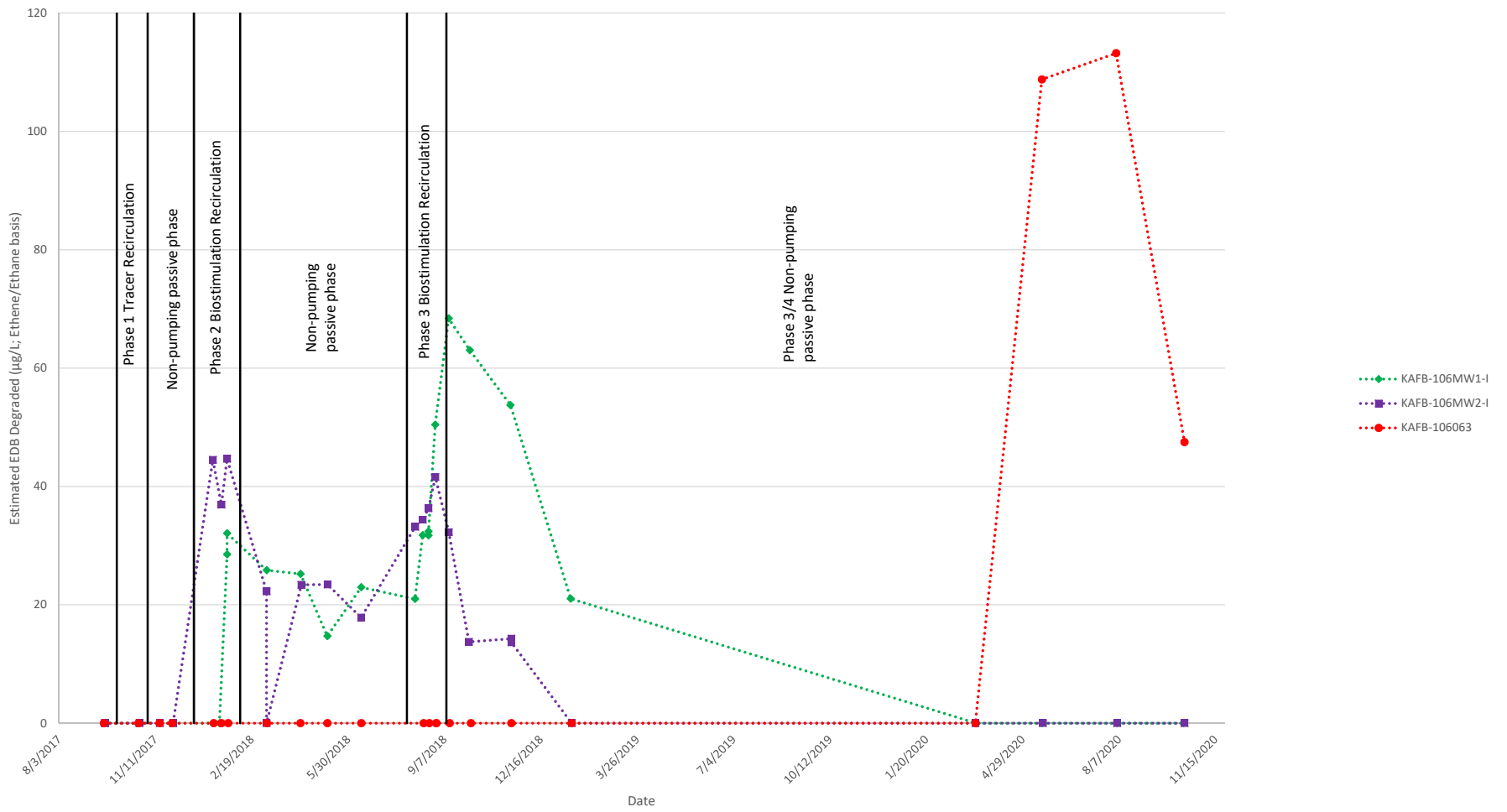

 APTIM Aptim Federal Services, LLC KIRTLAND AIR FORCE BASE NEW MEXICO	FIGURE 33
	ETHENE/ETHANE BASED ESTIMATE OF EDB DEGRADED - SHALLOW WELLS



 APTIM Aptim Federal Services, LLC KIRTLAND AIR FORCE BASE NEW MEXICO	FIGURE 34
	ETHENE/ETHANE BASED ESTIMATE OF EDB DEGRADED - INTERMEDIATE WELLS

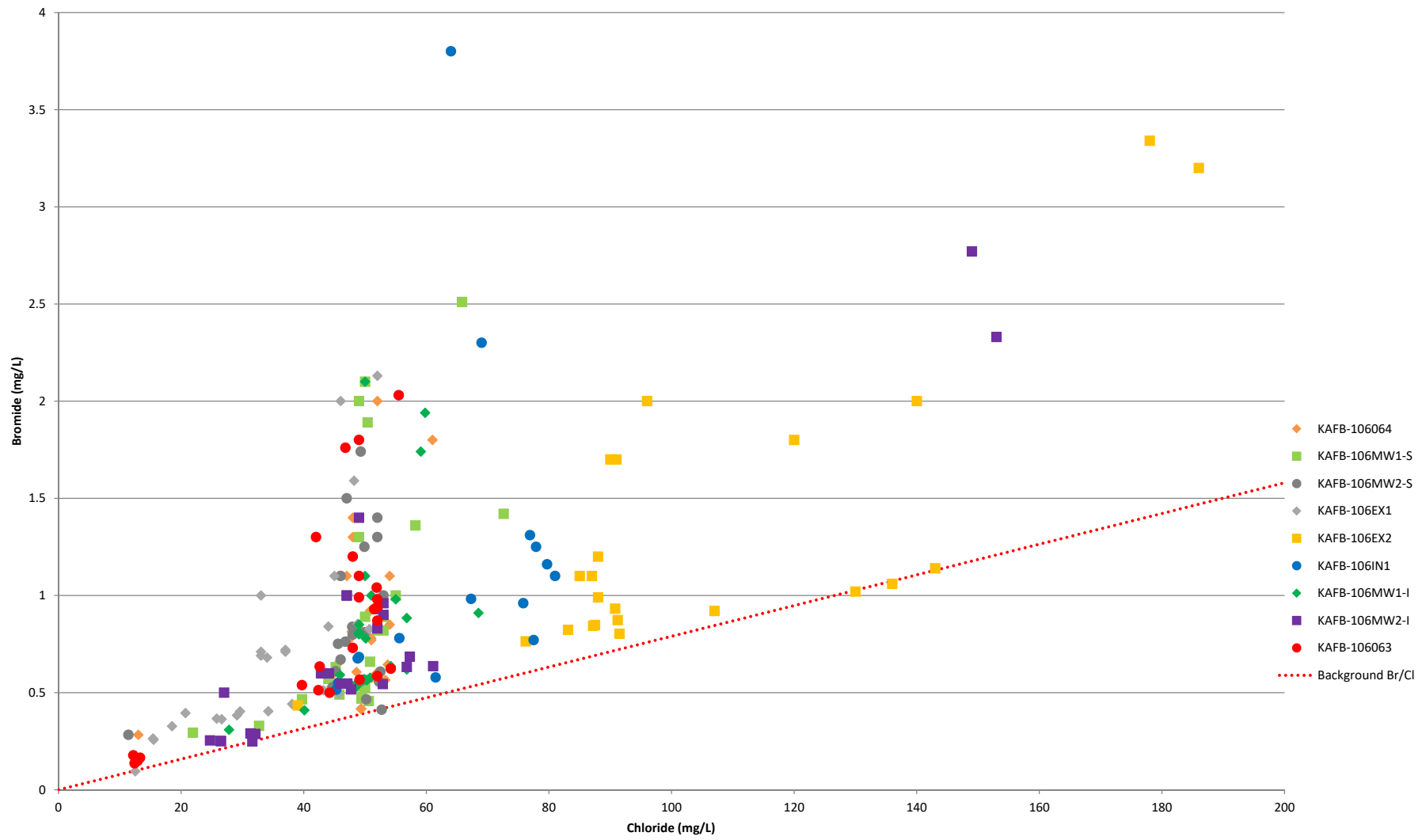

 Aptim Federal Services, LLC	FIGURE 35
	BROMIDE VS. CHLORIDE - ALL WELLS

KIRTLAND AIR FORCE BASE
NEW MEXICO

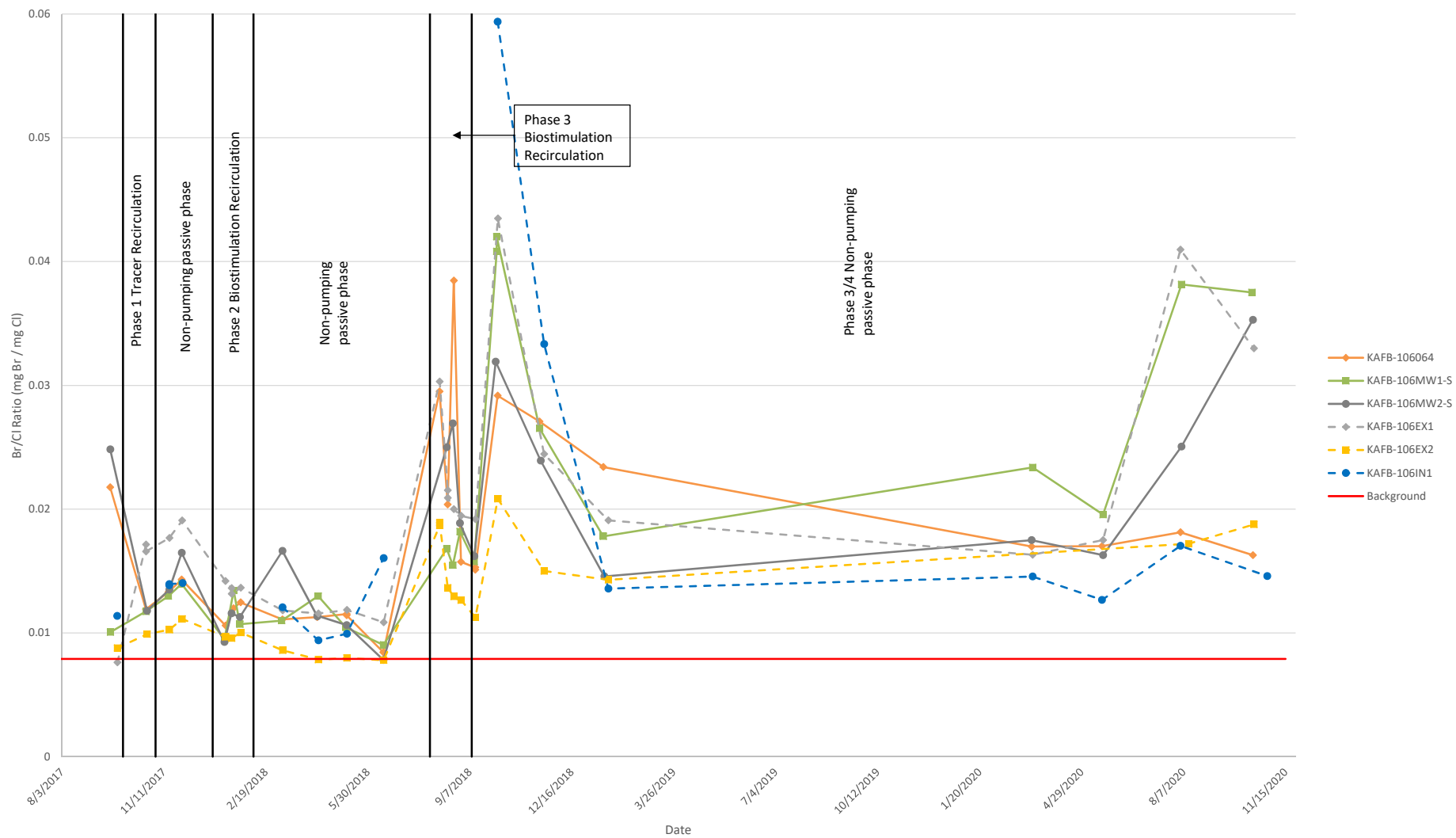

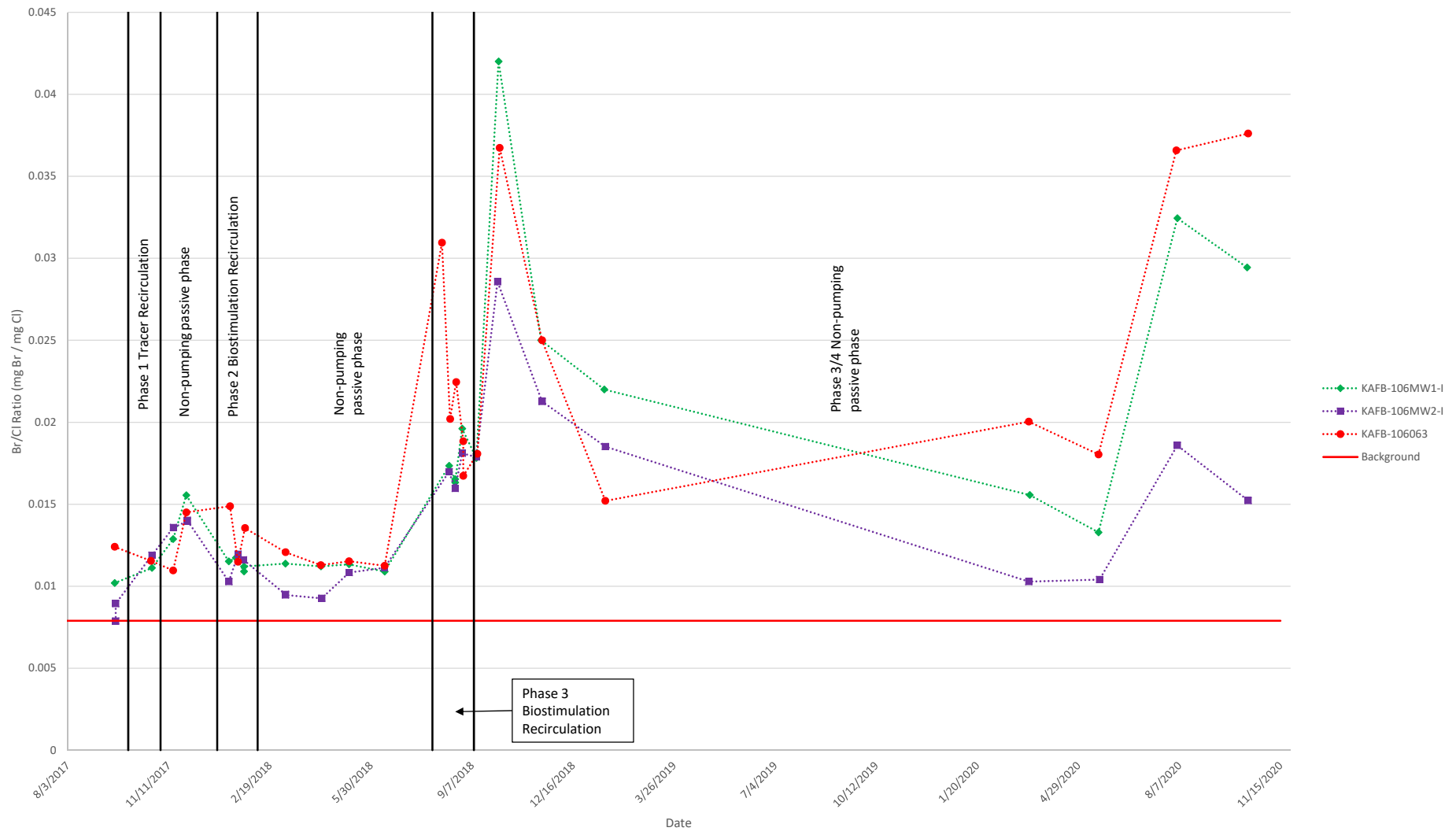

 APTIM Aptim Federal Services, LLC KIRTLAND AIR FORCE BASE NEW MEXICO	FIGURE 37
	BR/CL RATIO - INTERMEDIATE WELLS

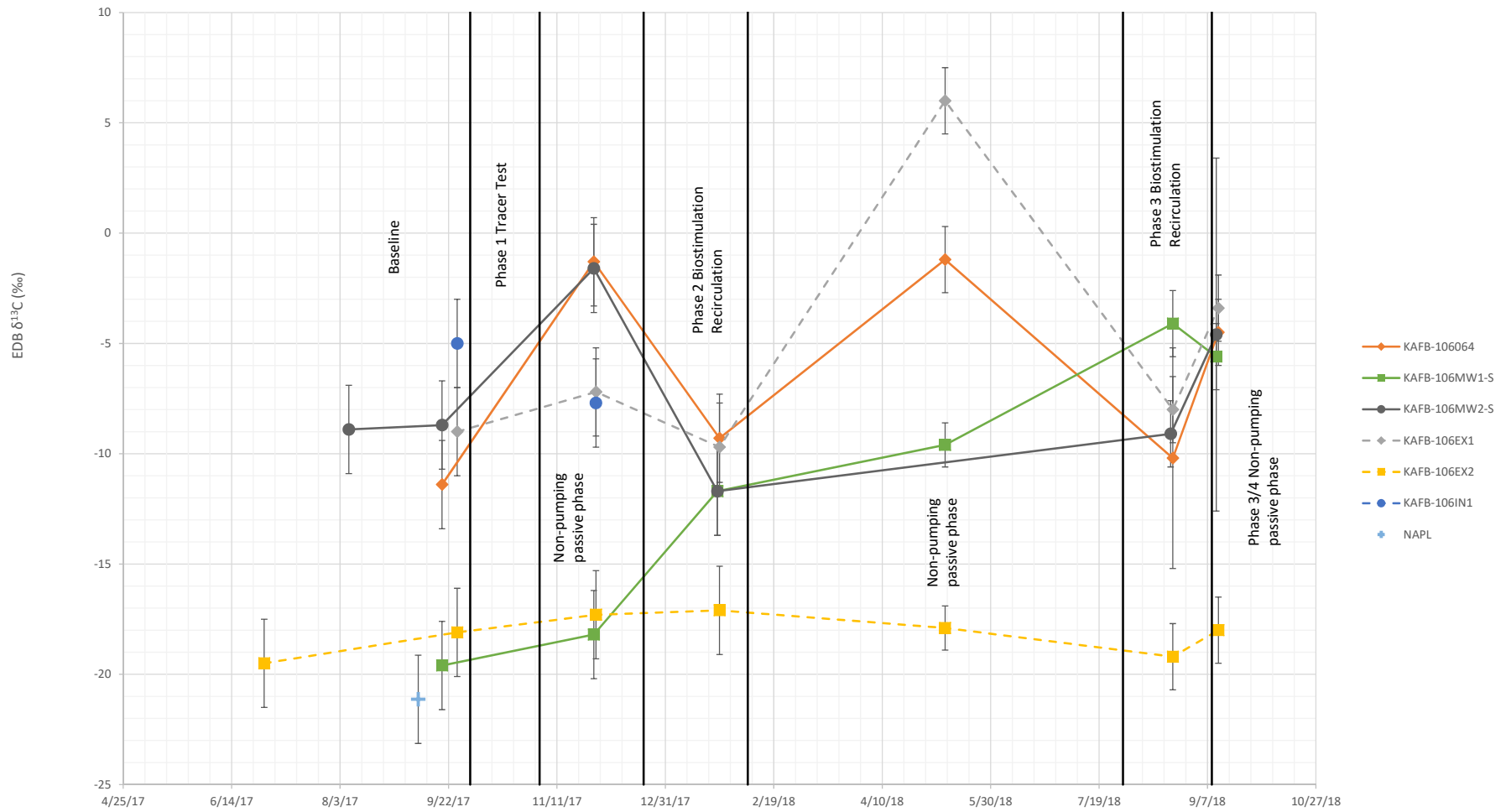

 APTIM Aptim Federal Services, LLC	FIGURE 38
	EDB $\Delta^{13}C$ - SHALLOW WELLS

KIRTLAND AIR FORCE BASE
NEW MEXICO

**Table 1
Well Completion and Survey Data**

Well ID	Well Type	Date Completed	Survey Date	Easting ^a	Northing ^a	Ground Elevation ^b	Top of Well Vault/Protective Casing Elevation ^b	Top of PVC Elevation ^b	Water Level (feet bgs) ^c	Screened Interval (feet bgs) ^d	Well Depth ^d (feet bgs)	Pump Intake (feet bgs) ^d	Casing Diameter (inches)	Casing Type
Newly Installed Wells														
KAFB-106EX1	Extraction	3/12/2017	9/28/2017	1542416.04	1473778.98	5349.35	5349.35	5345.82	477.00	487 - 502	507	491	6.00	SDR 17 PVC/SS Screen
KAFB-106EX2	Extraction	2/26/2017	9/28/2017	1542255.24	1473822.85	5346.84	5346.84	5343.50	477.00	487 - 502	507	491	6.00	SDR 17 PVC/SS Screen
KAFB-106IN1	Injection	3/20/2017	9/28/2017	1542327.02	1473797.07	5348.37	5348.37	5345.07	477.00	477 - 497	502	492	6.00	SDR 17 PVC/SS Screen
KAFB-106MW1-S	GWMW	1/12/2017	9/28/2017	1542355.49	1473838.55	5347.45	5347.53	5347.03	478.00	463 - 498	500.5	488	4.00	Schedule 80 PVC/Screen
KAFB-106MW1-I	GWMW							5347.07	478.00	513 - 523	528	518	3.00	Schedule 80 PVC/Screen
KAFB-106MW2-S	GWMW	2/16/2017	9/28/2017	1542305.04	1473785.32	5347.97	5348.06	5347.55	478.00	463 - 498	500.5	488	4.00	Schedule 80 PVC/Screen
KAFB-106MW2-I	GWMW							5347.57	478.00	513 - 523	528	518	3.00	Schedule 80 PVC/Screen
Existing Wells														
KAFB-106064	GWMW	4/8/2011	4/15/2011	1542358.76	1473788.79	5347.90	5351.10	5350.50	491.00	488 - 508	513	495	5.00	Schedule 80 PVC/Screen
KAFB-106063	GWMW	4/8/2011	4/15/2011	1542371.25	1473763.99	5348.50	5351.90	5351.20	491.40	508 - 523	528	511	5.00	Schedule 80 PVC/Screen

Notes:

^aHorizontal Coordinate System: NM_NAD83_ST_PL_Central_FIPS_3002_Feet. Measuring point is from the top of protective casing (GWMWs), or vault top (extraction and injection wells).

^bElevation above mean sea level. Ground elevation at GWMWs were measured at the northside of the concrete well pad. Ground Elevation at the extraction and injection wells was measured at the top of the well vault.

^cAverage water level measured during well completion, prior to well development.

^dScreened interval, well depth, and pump intake for existing wells KAFB-106064 and KAFB-106063 is measured from top of casing (approximately 3 feet above ground surface).

bgs - Below ground surface.

GWMW - Groundwater Monitoring Well.

ID - Identification.

KAFB - Kirtland Air Force Base.

NAD83 - North American Datum of 1983.

PVC - Polyvinyl chloride.

SS - Stainless steel.

**Table 2
Timeline of Pilot Test Activities**

Month	Year	Phase	Event	
January - March	2017	N/A	Drilling and construction of two nested groundwater monitoring wells, two extraction wells, and one injection well.	
March - May			Surface completion on wells and well development.	
March - May			Installation of system pipeline and utilities.	
April			Recirculation system delivered to site.	
May			Extraction and Injection well down-hole assembly installation; Geotech bladder pump installation.	
May			Recirculation system shakedown testing with Calcon.	
May - August			Troubleshoot Geotech bladder pump issues.	
June - August			Baseline samples collected from all wells except KAFB-106MW1-S due to pump failure.	
September			Installation of QED bladder pumps. NAPL detected in KAFB-106MW1-S.	
			Recollect baseline samples with new pumps.	
			Start system in preparation for Phase 1 on September 26, 2017.	
October - November			1	Phase 1 Recirculation (Tracer Test). Fluorescein and deuterated water were injected over a 24 hour period on October 2 through October 3.
November - December				Phase 1 Passive period.
December	2	Start system in preparation for Phase 2 on December 11, 2017.		
		Begin injecting amendments on December 22, 2017. Notice that chemical feed pump is leaking; crystallization is observed within check ball housing; turn off system on 12/23/17 to troubleshoot.		
		Remix amendment tank to include lower ratios of DAP and lactate. Resume injecting on 12/29/17.		
February	2	Finishing injecting amendments and groundwater for Phase 2 on 2/7/18. Total additions for Phase 2: 150 kg DAP, 290 gallons WilClear Plus®, and 71 kg KI.		
February - July		Phase 2 Passive period.		
July - August		Data from Phase 2 indicates biostimulation has effectively reduced concentrations of EDB within the pilot test area. Suggested that bioaugmentation be deferred for Phase 3 and additional biostimulation be performed. NMED concurs and approves the Phase 3 Notification Letter in a letter dated August 7, 2018.		
July - September	3	Start system for Phase 3 on July 30, 2018. Total additions for Phase 3: 143 kg DAP and 340 gallons WilClear plus. No tracer was used.		
September		Phase 3 Passive period began on September 9, 2018.		
September		During the first Phase 3 Passive sampling event (9/12/18), the Grundfos pump installed in the injection well failed to lift water after 40 minutes. Excessive drawdown was observed at injection well with transducer, and the pump was shutoff. Tripping out the transducer indicates fine sand, silt, and grey biological growth on the transducer. KAFB-106IN1 is not sampled.		
October - November		Samples from the injection well are collected by bailing the sound tube using a stainless steel bailer.		
November	4	Phase 4, long-term rebound monitoring began on November 19, 2018.		
January		Collect first Phase 4 sample on January 16, 17, and 21, 2019. System continues to remain off.		
March - October		Conduct first groundwater sampling event since January 2019 on March 11 and 12, 2020. Sample on a quarterly frequency.		

Notes:

DAP - Diammonium phosphate.

IN - Injection well.

KAFB - Kirtland Air Force Base.

kg - Kilograms.

KI - Potassium iodide.

MW - Monitoring well.

NAPL - Non-aqueous phase liquid.

NMED - New Mexico Environment Department.

**Table 3
Field Water Quality Measurements**

Location Name	Sample No.	Date	Time	Gallons Removed	Depth to Groundwater (feet below TOC) ^a	Depth to NAPL (feet below TOC) ^a	Temperature (°C)	pH (S.U.)	Specific Conductivity (mS/cm ²)	DO (mg/L)	ORP (mV)	Turbidity (NTU)
KAFB-106063	106063-BL-071817	7/18/2017	1057	2.5	NM	NM	20.2	7.19	0.379	0.04	-123.8	NR
	106063-BL-091817	9/18/2017	1309	2.5	480.24	NA	21.0	7.22	0.543	2.80	-13.5	0.72
	106063-P1R-100417	10/4/2017	1510	4	480.58	NA	21.0	7.23	0.512	1.27	-24.0	1.98
	106063-P1R-100617	10/6/2017	952	4	480.58	NA	18.3	7.20	0.495	1.03	82.8	2.01
	106063-P1R-100917	10/9/2017	1052	4	480.55	NA	18.6	7.30	0.493	1.06	66.1	1.48
	106063-P1R-101217	10/12/2017	0959	4	480.21	NA	18.5	7.12	0.474	1.18	108.1	1.57
	106063-P1R-101617	10/16/2017	1126	4	480.42	NA	18.3	7.12	0.464	1.41	138.0	1.63
	106063-P1R-102017	10/20/2017	1027	4	480.39	NA	17.8	7.17	0.440	1.65	157.7	1.19
	106063-P1R-102417	10/24/2017	0928	4	480.64	NA	16.7	7.31	0.417	1.94	156.3	1.10
	106063-P1R-110117	11/1/2017	0955	4	480.25	NA	17.6	7.18	0.440	2.83	207.9	1.56
	106063-P1P-111517	11/15/2017	0950	4	480.08	NA	17.4	7.15	0.436	1.78	181.6	2.09
	106063-P1P-112817	11/28/2017	1010	4	479.72	NA	16.3	7.26	0.425	1.59	152.8	2.43
	106063-P2R-011018	1/10/2018	1440	5	478.62	NA	15.3	7.14	0.658	0.70	-99.6	3.50
	106063-P2R-011818	1/18/2018	1150	5	478.99	NA	15.0	7.23	0.681	0.50	-130.2	3.42
	106063-P2R-012518	1/25/2018	1140	5	478.83	NA	16.0	7.19	0.696	0.33	-155.2	4.61
	106063-P2P-030618	3/6/2018	1440	4	478.68	NA	17.0	7.11	0.723	0.38	-166.7	3.41
	106063-P2P-041018	4/10/2018	1040	5	478.53	NA	17.7	6.99	0.772	0.46	-175.5	6.51
	106063-P2P-050818	5/8/2018	1100	5	478.22	NA	20.4	6.94	0.817	0.37	-188.3	4.17
	106063-P2P-061218	6/12/2018	1515	5	478.71	NA	24.4	6.94	0.869	0.14	-133.6	6.14
	106063-P3R-080818	8/8/2018	0955	5	478.99	NA	19.2	6.91	0.856	0.17	-175.3	1.59
	106063-P3R-081618	8/16/2018	0945	5	479.08	NA	19.1	6.89	0.866	0.14	-158.6	2.15
	106063-P3R-082218	8/22/2018	1000	5	479.25	NA	18.7	6.92	0.885	0.16	-128.2	3.69
	106063-P3R-082918	8/29/2018	0955	5	479.11	NA	18.8	6.81	0.894	0.16	-120.6	7.49
	106063-P3P-091218	9/12/2018	0935	5	479.07	NA	18.4	7.12	0.915	0.16	-109.3	1.65
	106063-P3P-100418	10/4/2018	1020	5	479.00	NA	18.9	6.88	0.839	0.10	-133.6	4.24
	106063-P3P-111518	11/15/2018	0915	5	479.00	NA	16.8	6.88	0.913	0.14	-111.3	1.81
	106063-P4P-011719	1/17/2019	0950	5	479.03	NA	16.7	6.78	0.980	0.16	-113.1	1.25
	106063-LTM-031120	3/11/2020	1420	6.2	474.18	NA	17.6	6.92	1.079	0.16	-84.6	1.46
	106063-LTM-051920	5/19/2020	1018	8.0	473.91	NA	18.9	6.90	1.051	0.13	-168.6	1.98
	106063-LTM-080420	8/4/2020	1405	8.1	474.95	NA	20.0	6.85	1.053	0.06	-134.3	9.32
106063-LTM-101420	10/14/2020	0958	7.7	475.70	NA	18.3	6.87	0.868	0.21	-129.9	9.38	

**Table 3
Field Water Quality Measurements**

Location Name	Sample No.	Date	Time	Gallons Removed	Depth to Groundwater (feet below TOC) ^a	Depth to NAPL (feet below TOC) ^a	Temperature (°C)	pH (S.U.)	Specific Conductivity (mS/cm ²)	DO (mg/L)	ORP (mV)	Turbidity (NTU)
KAFB-106064	106064-BL-081617	8/16/2017	1033	4	NM	NM	19.1	7.00	0.413	0.71	-132.7	7.89
	106064-BL-091917	9/19/2017	1042	4.5	479.45	NA	19.6	6.90	0.607	0.52	-180.5	10.0
	106064-P1R-100417	10/4/2017	1510	4	480.58	NA	19.7	7.04	0.750	0.22	-138.7	5.03
	106064-P1R-100617	10/6/2017	0925	3.5	480.58	NA	18.2	7.20	0.758	0.09	-152.2	4.12
	106064-P1R-100917	10/9/2017	1450	3.5	479.43	NA	18.3	7.11	0.751	0.11	-157.8	1.34
	106064-P1R-101217	10/12/2017	1348	2.5	479.43	NA	19.7	7.12	0.756	0.00	-241.6	0.64
	106064-P1R-101617	10/16/2017	1423	2.6	479.43	NA	18.9	7.13	0.728	0.00	-236.0	0.97
	106064-P1R-102017	10/20/2017	1420	2.9	479.50	NA	19.0	7.13	0.721	0.00	-238.2	0.75
	106064-P1R-102417	10/24/2017	1120	4	479.61	NA	18.0	7.09	0.707	0.00	-257.5	0.91
	106064-P1R-110117	11/1/2017	1340	4.4	479.60	NA	18.7	7.02	0.719	0.00	-229.6	1.58
	106064-P1P-111517	11/15/2017	1151	4.5	479.28	NA	17.7	6.92	0.749	0.27	-185.3	4.59
	106064-P1P-112817	11/28/2017	1210	4.5	479.88	NA	17.0	6.96	0.741	0.29	-176.3	4.01
	106064-P2R-011018	1/10/2018	1338	4.5	477.60	NA	16.3	6.90	0.873	0.14	-143.4	2.90
	106064-P2R-011818	1/18/2018	1015	3.2	478.06	NA	16.3	6.74	0.886	0.15	-150.9	3.92
	106064-P2R-012518	1/25/2018	0930	3.5	477.85	NA	15.4	6.70	0.964	0.15	-143.2	4.23
	106064-P2P-030718	3/7/2018	0935	3.5	477.82	NA	16.3	6.80	1.024	0.15	-155.4	2.17
	106064-P2P-041018	4/10/2018	0910	4	477.70	NA	17.4	6.72	1.057	0.14	-180.0	1.88
	106064-P2P-050918	5/9/2018	0904	4	477.40	NA	18.8	6.75	1.068	0.15	-455.5	4.53
	106064-P2P-061418	6/14/2018	1005	5	477.90	NA	20.3	6.76	1.055	0.05	-131.8	11.8
	106064-P3R-080818	8/8/2018	0910	4	478.02	NA	18.9	6.68	1.030	0.08	-103.9	6.51
	106064-P3R-081618	8/16/2018	0925	5	478.12	NA	19.3	6.74	1.011	0.09	-118.0	5.18
	106064-P3R-082218	8/22/2018	0930	5	478.15	NA	18.6	6.64	1.023	0.09	-112.9	6.25
	106064-P3R-082918	8/29/2018	0922	5	478.15	NA	19.0	6.64	1.015	0.10	-114.2	7.21
	106064-P3P-091218	9/12/2018	0900	5	478.20	NA	18.9	6.72	1.031	0.09	-124.9	5.15
	106064-P3P-100418	10/4/2018	0920	5	478.00	NA	18.6	6.63	1.039	0.10	-126.5	7.84
	106064-P3P-111418	11/14/2018	0952	5	478.25	NA	17.0	6.86	1.049	0.12	-172.0	2.50
	106064-P4P-011619	1/16/2019	0952	5	478.15	NA	16.5	6.71	1.085	0.12	-126.5	3.09
	106064-LTM-031120	3/11/2020	1025	5.7	473.35	NA	17.3	6.82	1.108	0.05	-116.4	1.27
	106064-LTM-051920	5/19/2020	0957	6.1	473.08	NA	18.3	6.81	1.215	0.05	-193.6	4.84
	106064-LTM-080420	8/4/2020	0924	5.0	473.90	NA	19.3	6.66	1.264	0.04	-148.3	7.64
106064-LTM-101420	10/14/2020	0905	4.8	474.93	NA	17.6	6.72	1.189	0.00	-100.9	9.30	
KAFB-106MW1-S	106MW1S-BL-091917	9/19/2017	1510	3	476.32	476.08	20.8	7.19	0.738	0.99	-145.2	15.1
	106MW1S-P1R-100417	10/4/2017	1200	5.5	476.56	476.30	19.4	7.17	0.704	0.54	-140.9	5.95
	106MW1S-P1R-100617	10/6/2017	1453	5	476.31	NM	19.9	8.40*	0.736	0.34	-139.6	2.43
	106MW1S-P1R-100917	10/9/2017	1218	5	476.19	476.01	18.3	7.20	0.729	0.23	-138.3	2.28
	106MW1S-P1R-101217	10/12/2017	1120	5	476.31	476.10	18.8	7.29	0.736	0.10	-163.7	2.01
	106MW1S-P1R-101617	10/16/2017	1213	3.6	476.54	476.29	18.7	7.31	0.744	0.04	-173.6	1.31
	106MW1S-P1R-102017	10/20/2017	1141	4.1	475.91	475.90	18.6	7.32	0.761	0.03	-172.9	1.04

**Table 3
Field Water Quality Measurements**

Location Name	Sample No.	Date	Time	Gallons Removed	Depth to Groundwater (feet below TOC) ^a	Depth to NAPL (feet below TOC) ^a	Temperature (°C)	pH (S.U.)	Specific Conductivity (mS/cm ²)	DO (mg/L)	ORP (mV)	Turbidity (NTU)
KAFB-106MW1-S	106MW1S-P1R-102417	10/24/2017	1316	4	476.29	476.13	18.9	7.29	0.750	0.00	-192.2	1.11
	106MW1S-P1R-110117	11/1/2017	1125	4.7	475.65	NA	18.2	7.21	0.747	0.02	-169.1	1.22
	106MW1S-P1P-111517	11/15/2017	1133	6	475.80	NA	17.9	7.28	0.753	0.05	-207.0	5.42
	106MW1S-P1P-112817	11/28/2017	1125	4.5	475.46	NA	17.4	7.16	0.773	0.10	-187.8	3.31
	106MW1S-P2R-010918	1/9/2018	1307	4.5	474.55	NA	17.6	7.04	0.856	0.18	-153.5	3.28
	106MW1S-P2R-011818	1/18/2018	1400	4.5	474.50	NA	17.1	7.02	0.890	0.13	-180.0	4.12
	106MW1S-P2R-012418	1/24/2018	1316	3.5	474.60	NA	15.7	6.93	0.914	0.14	-159.2	4.42
	106MW1S-P2P-030618	3/6/2018	1300	4.5	474.35	NA	16.6	7.08	0.995	0.14	-166.0	2.49
	106MW1S-P2P-041118	4/11/2018	0920	4	474.00	NA	17.9	7.00	1.034	0.14	-174.9	2.29
	106MW1S-P2P-050818	5/8/2018	1429	6	473.96	NA	20.8	6.88	1.070	0.11	-585.7	2.09
	106MW1S-P2P-061418	6/14/2018	0810	6	474.53	NA	19.3	7.11	0.998	0.11	-121.5	8.58
	106MW1S-P3R-080718	8/7/2018	1315	6	474.64	NA	20.4	6.86	1.029	0.07	-104.8	4.99
	106MW1S-P3R-081518	8/15/2018	1125	6	474.63	NA	19.7	6.93	1.004	0.06	-124.9	7.18
	106MW1S-P3R-082118	8/21/2018	1125	6	474.80	NA	20.1	6.81	1.016	0.07	-108.1	5.84
	106MW1S-P3R-082818	8/28/2018	1135	6	474.66	NA	19.5	6.81	1.026	0.07	-103.0	5.89
	106MW1S-P3P-091118	9/11/2018	1130	6	474.75	NA	19.2	6.82	1.034	0.08	-114.9	5.14
	106MW1S-P3P-100318	10/3/2018	1020	6	474.78	NA	18.5	6.69	1.068	0.09	-110.0	5.07
	106MW1S-P3P-111418	11/14/2018	1207	6	474.60	NA	16.5	6.87	1.089	0.12	-119.5	5.56
	106MW1S-P4P-011619	1/16/2019	1314	6	473.60	NA	17.3	6.97	1.124	0.03	-126.2	1.43
	106MW1S-LTM-031220	3/12/2020	1100	9.6	469.80	NA	17.8	6.99	1.159	0.07	-89.1	1.99
106MW1S-LTM-052020	5/20/2020	1000	7.0	469.70	NA	18.5	6.89	1.189	0.13	-121.2	2.35	
106MW1S-LTM-080520	8/5/2020	1055	12.2	470.70	NA	19.5	6.76	1.072	0.06	-138.6	3.72	
106MW1S-LTM-101320	10/13/2020	1209	6.9	471.60	NA	19.2	6.80	0.927	0.41	-122.3	6.23	

**Table 3
Field Water Quality Measurements**

Location Name	Sample No.	Date	Time	Gallons Removed	Depth to Groundwater (feet below TOC) ^a	Depth to NAPL (feet below TOC) ^a	Temperature (°C)	pH (S.U.)	Specific Conductivity (mS/cm ²)	DO (mg/L)	ORP (mV)	Turbidity (NTU)
KAFB-106MW1-I	106MW1I-BL-071817	7/18/2017	1245	2	475.94	NA	19.3	7.55	0.445	9.59	220.1	1.06
	106MW1I-BL-091817	9/18/2017	1140	2	476.12	NA	19.2	7.48	0.460	7.37	194.5	3.02
	106MW1I-P1R-100417	10/4/2017	0920	3	NM	NM	18.5	7.52	0.464	7.79	145.2	0.85
	106MW1I-P1R-100617	10/6/2017	1055	3	NM	NM	18.7	7.16	0.464	7.69	117.7	0.61
	106MW1I-P1R-100917	10/9/2017	0955	8.7 L	NM	NM	18.2	7.13	0.466	7.81	140.0	0.62
	106MW1I-P1R-101217	10/12/2017	0915	2.9	NM	NM	17.9	7.60	0.410	8.33	230.4	0.73
	106MW1I-P1R-101617	10/16/2017	1018	2.5	NM	NM	18.0	7.62	0.406	8.58	180.5	0.82
	106MW1I-P1R-102017	10/20/2017	0955	3.1	NM	NM	18.1	7.60	0.414	8.51	147.3	0.91
	106MW1I-P1R-102517	10/25/2017	0946	4	NM	NM	17.5	7.47	0.490	8.40	41.0	1.79
	106MW1I-P1R-110117	11/1/2017	0930	3.8	NM	NM	17.6	7.26	0.611	7.18	26.8	2.53
	106MW1I-P1P-111517	11/15/2017	0916	4	NM	NM	17.5	7.23	0.553	1.72	-124.9	4.11
	106MW1I-P1P-112817	11/28/2017	0930	5	NM	NM	17.4	7.24	0.488	3.95	36.9	2.09
	106MW1I-P2R-010918	1/9/2018	1114	4	NM	NM	17.0	7.12	0.782	0.83	-153.1	4.76
	106MW1I-P2R-011618	1/16/2018	1030	7	NM	NM	15.3	7.12	0.810	0.43	-158.0	2.81
	106MW1I-P2R-012418	1/24/2018	1052	7.5	NM	NM	16.5	6.94	0.839	0.27	-155.7	3.50
	106MW1I-P2P-030618	3/6/2018	1025	8	NM	NM	16.6	7.22	0.838	0.33	-200.3	4.17
	106MW1I-P2P-041018	4/10/2018	1405	7	NM	NM	18.7	7.22	0.796	0.25	-206.0	2.31
	106MW1I-P2P-050818	5/8/2018	1018	7	NM	NM	19.2	7.10	0.785	0.27	-203.4	2.09
	106MW1I-P2P-061218	6/12/2018	1455	6	NM	NM	21.1	7.11	0.822	0.21	-159.1	4.51
	106MW1I-P3R-080718	8/7/2018	1027	6	NM	NM	19.4	7.06	0.820	0.19	-129.5	2.95
	106MW1I-P3R-081518	8/15/2018	0935	5	NM	NM	18.9	7.10	0.894	0.08	-147.8	3.95
	106MW1I-P3R-082118	8/21/2018	0925	5	NM	NM	19.0	7.02	0.943	0.09	-148.0	5.03
	106MW1I-P3R-082818	8/28/2018	0920	5	NM	NM	18.8	7.00	0.981	0.09	-145.4	5.08
	106MW1I-P3P-091118	9/11/2018	0932	5	NM	NM	18.6	7.08	1.030	0.10	-150.1	7.15
	106MW1I-P3P-100318	10/3/2018	0855	5	NM	NM	18.2	6.92	0.944	0.10	-142.2	4.13
	106MW1I-P3P-111418	11/14/2018	1027	5	NM	NM	17.1	6.87	0.971	0.02*	-123.6	4.74
	106MW1I-P4P-011619	1/16/2019	1119	5	NM	NM	17.0	7.20	0.827	0.09	-138.2	1.11
	106MW1I-LTM-031220	3/12/2020	1528	11.5	NM	NM	17.9	7.03	0.852	0.08	-122.8	1.48
	106MW1I-LTM-051920	5/19/2020	1433	7.5	NM	NM	23.1	6.89	0.824	0.27	-206.1	2.22
	106MW1I-LTM-080520	8/5/2020	1520	12.2	NM	NM	19.6	6.82	0.831	0.12	-152.7	2.52
106MW1I-LTM-101320	10/13/2020	0940	6.6	NM	NM	18.2	6.81	0.803	0.37	-141.6	3.40	

**Table 3
Field Water Quality Measurements**

Location Name	Sample No.	Date	Time	Gallons Removed	Depth to Groundwater (feet below TOC) ^a	Depth to NAPL (feet below TOC) ^a	Temperature (°C)	pH (S.U.)	Specific Conductivity (mS/cm ²)	DO (mg/L)	ORP (mV)	Turbidity (NTU)
KAFB-106MW2-S	106MW2S-BL-080717	8/7/2017	1234	3	NM	NM	19.6	7.10	0.875	1.01	-93.2	14.8
	106MW2S-BL-091917	9/19/2017	1225	3	NM	NM	19.7	6.94	0.765	0.98	-167.8	7.17
	106MW2S-P1R-100417	10/4/2017	0948	4	NM	NM	18.7	7.21	0.760	0.75	-188.9	2.45
	106MW2S-P1R-100617	10/6/2017	1142	4	NM	NM	19.0	7.26	0.803	0.50	-196.9	4.6
	106MW2S-P1R-100917	10/9/2017	1446	4	NM	NM	18.3	7.39	0.789	0.52	-191.4	2.41
	106MW2S-P1R-101217	10/12/2017	1412	4	NM	NM	19.2	7.24	0.761	0.35	-200.4	2.26
	106MW2S-P1R-101617	10/16/2017	1445	4	NM	NM	19.3	7.28	0.753	0.28	-207.2	2.91
	106MW2S-P1R-102017	10/20/2017	1429	4	NM	NM	18.9	7.32	0.728	0.25	-218.0	4.42
	106MW2S-P1R-102517	10/25/2017	1323	4	NM	NM	18.9	7.31	0.708	0.00	-214.1	1.19
	106MW2S-P1R-110117	11/1/2017	1413	4	NM	NM	18.7	7.15	0.759	0.24	-214.8	1.90
	106MW2S-P1P-111617	11/16/2017	0921	4.5	NM	NM	17.5	7.30	0.786	0.06	-198.3	12.3
	106MW2S-P1P-112817	11/28/2017	1302	3.5	NM	NM	18.0	7.21	0.863	0.07	-204.3	3.85
	106MW2S-P2R-010918	1/9/2018	1045	3.5	NM	NM	17.3	6.85	0.852	0.41	-196.2	3.52
	106MW2S-P2R-011618	1/16/2018	0945	4	NM	NM	13.7	6.91	0.870	0.35	-172.1	3.10
	106MW2S-P2R-012418	1/24/2018	1345	4	NM	NM	16.3	6.74	0.970	0.32	-174.1	2.97
	106MW2S-P2P-030718	3/7/2018	0940	4	NM	NM	15.9	6.78	1.039	0.34	-183.1	3.35
	106MW2S-P2P-041018	4/10/2018	1305	4	NM	NM	19.4	6.91	1.168	0.30	-231.1	5.39
	106MW2S-P2P-050918	5/9/2018	0915	4	NM	NM	19.0	7.02	1.132	0.32	-226.5	7.19
	106MW2S-P2P-061418	6/14/2018	0905	4	NM	NM	18.9	7.00	1.094	0.06	-150.2	4.97
	106MW2S-P3R-080718	8/7/2018	1020	5	NM	NM	19.1	6.74	1.097	0.25	-108.6	8.79
	106MW2S-P2R-081518	8/15/2018	1130	5	NM	NM	19.7	6.73	1.021	0.11	-153.8	2.89
	106MW2S-P3R-082118	8/21/2018	1140	5	NM	NM	20.1	6.70	1.017	0.12	-151.1	2.88
	106MW2S-P3R-082818	8/28/2018	0945	5	NM	NM	18.6	6.73	1.057	0.13	-150.0	5.15
	106MW2S-P3P-091118	9/11/2018	1200	5	NM	NM	19.4	7.10	0.992	0.13	-158.7	2.77
	106MW2S-P3P-100218	10/2/2018	1040	5	NM	NM	19.0	6.74	0.999	0.07	-165.2	7.59
	106MW2S-P3P-111518	11/15/2018	1423	5	NM	NM	17.9	6.85	1.052	0.12	-132.0	9.91
	106MW2S-P4P-011719	1/17/2019	1307	5	NM	NM	17.6	6.89	1.129	0.02	-151.0	9.40
	106MW2S-LTM-031120	3/11/2020	1542	10.5	NM	NM	17.5	6.91	1.093	0.06	-130.7	3.69
	106MW2S-LTM-052020	5/20/2020	1105	12	470.15	NA	19.0	6.77	1.029	0.19	-164.4	3.24
	106MW2S-LTM-080520	8/5/2020	1055	9.1	470.82	NM	19.8	6.81	0.799	0.18	-118.8	2.51
106MW2S-LTM-101420	10/14/2020	1400	6.1	NM	NM	18.8	6.84	0.885	0.30	-154.0	8.73	

**Table 3
Field Water Quality Measurements**

Location Name	Sample No.	Date	Time	Gallons Removed	Depth to Groundwater (feet below TOC) ^a	Depth to NAPL (feet below TOC) ^a	Temperature (°C)	pH (S.U.)	Specific Conductivity (mS/cm ²)	DO (mg/L)	ORP (mV)	Turbidity (NTU)
KAFB-106MW2-1	106MW2I-BL-072417	7/24/2017	1124	2.5	NM	NM	19.3	7.23	0.431	6.70	199.2	2.84
	106MW2I-BL-091917	9/19/2017	1337	2.5	NM	NM	19.7	7.26	0.454	1.72	-118.1	3.16
	106M21I-P1R-100417	10/4/2017	1142	4	NM	NM	18.6	7.26	0.518	2.38	-154.2	3.08
	106M21I-P1R-100617	10/6/2017	1412	4	NM	NM	19.4	7.24	0.530	2.24	-156.7	4.85
	106M21I-P1R-100917	10/9/2017	1216	4	NM	NM	18.3	7.32	0.559	2.28	-140.5	6.20
	106MW2I-P1R-101217	10/12/2017	1130	4	NM	NM	18.4	7.21	0.558	2.23	-137.2	5.71
	106MW2I-P1R-101617	10/16/2017	1251	4	NM	NM	18.8	7.22	0.701	1.50	-160.3	3.81
	106MW2I-P1R-102017	10/20/2017	1153	4	NM	NM	18.6	7.30	0.732	0.52	-218.3	4.84
	106MW2I-P1R-102517	10/25/2017	1117	4	NM	NM	18.1	7.38	0.685	0.14	-228.9	6.55
	106MW2I-P1R-110117	11/1/2017	1126	4	NM	NM	18.3	7.31	0.767	0.28	-271.0	5.64
	106MW2I-P1P-111517	11/15/2017	1438	4	NM	NM	18.2	7.50	0.749	0.04	-265.4	2.48
	106MW2I-P1P-112917	11/29/2017	0929	4	NM	NM	17.4	7.45	0.695	0.07	-259.1	2.07
	106MW2I-P2R-010918	1/9/2018	1353	4	NM	NM	17.5	7.07	0.874	0.35	-226.8	3.17
	106MW2I-P2R-011818	1/18/2018	1355	4	NM	NM	17.3	7.15	0.870	0.30	-234.1	5.19
	106MW2I-P2R-012418	1/24/2018	0940	4	NM	NM	15.6	7.01	0.872	0.35	-230.7	3.50
	106MW2I-P2P-030618	3/6/2018	1013	4	NM	NM	16.5	7.09	0.585	0.35	-211.3	3.68
	106MW2I-P2P-041118	4/11/2018	1020	5	NM	NM	18.8	6.96	0.620	0.38	-198.7	4.67
	106MW2I-P2P-050818	5/8/2018	1400	5	NM	NM	20.5	6.96	0.800	0.34	-214.8	3.34
	106MW2I-P2P-061218	6/12/2018	1020	5	NM	NM	19.9	7.07	0.830	0.02	-154.8	4.34
	106MW2I-P3R-080718	8/7/2018	1410	5	NM	NM	21.7	6.93	0.919	0.14	-137.8	7.98
	106MW2I-P3R-081518	8/15/2018	0945	5	NM	NM	19.3	6.88	0.912	0.13	-139.2	3.54
	106MW2I-P3R-082118	8/21/2018	0950	5	NM	NM	19.2	6.86	0.904	0.14	-141.6	1.39
	106MW2I-P3R-082818	8/28/2018	1140	5	NM	NM	19.7	7.45	0.938	0.13	-132.5	3.47
	106MW2I-P3P-091118	9/11/2018	1015	5	NM	NM	19.1	7.06	0.976	0.15	-130.1	1.40
	106MW2I-P3P-100218	10/2/2018	0900	5	NM	NM	18.1	6.73	0.869	0.11	-137.2	4.98
	106MW2I-P3P-111518	11/15/2018	0942	5	NM	NM	17.1	6.86	0.861	0.02*	-140.1	4.13
	106MW2I-P4P-011719	1/17/2019	1025	5	NM	NM	16.8	7.20	0.575	0.15	-146.4	0.32
	106MW2I-LTM-031120	3/11/2020	1110	10	NM	NM	17.4	7.21	0.457	0.80	-50.2	2.75
	106MW2I-LTM-052020	5/20/2020	1350	9.6	NM	NM	19.7	6.98	0.603	0.45	-114.4	3.60
	106MW2I-LTM-080520	8/5/2020	1435	7.9	NM	NM	19.5	6.89	0.790	0.22	-94.4	1.98
106MW2I-LTM-101420	10/14/2020	1423	8.6	NM	NM	19.1	6.94	1.057	0.09	-92.1	7.53	

**Table 3
Field Water Quality Measurements**

Location Name	Sample No.	Date	Time	Gallons Removed	Depth to Groundwater (feet below TOC) ^a	Depth to NAPL (feet below TOC) ^a	Temperature (°C)	pH (S.U.)	Specific Conductivity (mS/cm ²)	DO (mg/L)	ORP (mV)	Turbidity (NTU)
KAFB-106EX1	106EX1-BL-062917	6/29/2017	0953	3.5	482.37	NM	20.2	7.29	0.570	0.36	-116.0	2.79
	106EX1-BL-092617	9/26/2017	1218	3.5	481.75	NM	20.3	7.02	0.650	0.53	-162.8	14.8
	106EX1-P1R-100417	10/4/2017	1553	3.5	482.65	NM	20.6	7.04	0.551	2.70	-53.2	1.61
	106EX1-P1R-100617	10/6/2017	1526	3.5	482.31	NM	20.7	7.04	0.541	2.19	-74.9	1.61
	106EX1-P1R-100917	10/9/2017	1524	3.5	480.21	NM	20.0	7.12	0.547	2.29	-69.1	2.72
	106EX1-P1R-101217	10/12/2017	1503	3.5	482.50	NM	20.7	7.07	0.497	2.21	-26.0	0.93
	106EX1-P1R-101617	10/16/2017	1514	3.5	484.20	NM	20.4	7.16	0.479	2.26	-50.0	1.34
	106EX1-P1R-102017	10/20/2017	1505	3.5	480.50	NM	20.5	7.10	0.473	2.05	-70.0	1.27
	106EX1-P1R-102417	10/24/2017	1404	5	482.40	NM	20.3	7.10	0.490	2.08	-69.9	2.96
	106EX1-P1R-110117	11/1/2017	1445	5	483.36	NM	20.2	6.93	0.555	1.72	-104.3	2.22
	106EX1-P1P-111617	11/16/2017	1316	16	482.24	NM	20.3	7.08	0.534	1.1	-129.9	5.49
	106EX1-P1P-112917	11/29/2017	1243	15	480.50	NM	19.6	7.05	0.575	0.56	-122.7	4.91
	106EX1-P2R-011018	1/10/2018	1028	2.5	481.41	NM	19.3	6.95	0.600	0.61	-101.5	4.05
	106EX1-P2R-011618	1/16/2018	1150	5	480.43	NM	18.3	6.96	0.604	0.41	-115.4	3.65
	106EX1-P2R-012518	1/25/2018	1305	5	480.64	NM	19.5	6.88	0.637	0.39	-122.6	3.28
	106EX1-P2P-030718	3/7/2018	1440	5	481.40	NM	20.0	6.82	0.707	0.60	-153.9	4.75
	106EX1-P2P-041118	4/11/2018	1450	5	480.50	NM	20.6	6.82	0.756	0.28	-175.3	12.7
	106EX1-P2P-050918	5/9/2018	1435	6	482.01	NM	20.6	6.84	0.818	0.31	-139.8	6.01
	106EX1-P2P-061418	6/14/2018	1428	10	478.89	NM	20.7	6.88	0.861	0.26	-90.0	9.16
	106EX1-P3R-080818	8/8/2018	1155	6	480.50	NM	20.6	6.92	0.720	0.18	-75.9	5.27
	106EX1-P3R-081618	8/16/2018	1110	7	480.50	NM	20.7	6.89	0.753	0.19	-79.2	1.95
	106EX1-P3R-082218	8/22/2018	1105	6	480.50	NM	20.5	7.01	0.757	0.25	-85.0	2.47
	106EX1-P3R-082918	8/29/2018	1115	7	480.65	NM	20.7	6.89	0.758	0.13	-96.1	9.11
	106EX1-P3P-091218	9/12/2018	1255	6	476.49	NM	21.2	6.93	0.815	0.54	-117.0	9.01
	106EX1-P3P-100418	10/4/2018	1440	8	475.35	NM	21.0	6.82	0.996	0.21	-116.8	9.59
	106EX1-P3P-111918	11/19/2018	1345	8	480.32	NM	20.1	6.93	0.911	1.22	-83.2	NR
	106EX1-P4P-012119	1/21/2019	1208	8	478.20	NM	19.4	7.08	0.959	0.73	-110.0	4.80
	106EX1-LTM-031220	3/12/2020	1035	4.5	468.26	467.85	17.1	6.89	1.107	0.29	-74.6	4.23
	106EX1-LTM-052020	5/20/2020	1445	5.5	467.98	467.45	20.1	6.89	1.118	0.22	-124.1	NR
	106EX1-LTM-080420	8/4/2020	1455	5.7	468.44	468.41	22.7	6.85	0.670	0.48	-85.7	4.52
106EX1-LTM-101520	10/15/2020	1230	1.5	469.54	NA	23.9	6.86	0.931	7.35	-63.4	54.2	

**Table 3
Field Water Quality Measurements**

Location Name	Sample No.	Date	Time	Gallons Removed	Depth to Groundwater (feet below TOC) ^a	Depth to NAPL (feet below TOC) ^a	Temperature (°C)	pH (S.U.)	Specific Conductivity (mS/cm ²)	DO (mg/L)	ORP (mV)	Turbidity (NTU)
KAFB-106EX2	106EX2-BL-062917	6/29/2017	1050	3.5	478.34	NM	20.4	7.40	0.883	0.57	-113.0	3.61
	106EX2-BL-092617	9/26/2017	1257	3.5	476.75	NM	20.4	7.04	0.873	0.50	-157.8	2.27
	106EX2-P1R-100417	10/4/2017	1616	3.5	480.19	NM	20.6	7.12	0.918	0.89	-72.8	1.70
	106EX2-P1R-100617	10/6/2017	1551	3.5	479.60	NM	20.7	7.08	0.929	0.81	-65.3	1.27
	106EX2-P1R-100917	10/9/2017	1554	3.5	482.40	NM	20.2	7.14	0.936	0.61	-70.8	1.59
	106EX2-P1R-101217	10/12/2017	1531	3.5	480.40	NM	20.6	7.09	0.824	0.15	-43.9	0.83
	106EX2-P1R-101617	10/16/2017	1548	3.5	480.50	NM	20.5	7.12	0.843	0.02	-60.4	0.87
	106EX2-P1R-102017	10/20/2017	1540	3.5	478.10	NM	20.8	7.10	0.879	0.00	-75.9	0.78
	106EX2-P1R-102517	10/25/2017	1410	5	483.00	NM	20.4	7.07	0.834	0.04	-87.7	1.46
	106EX2-P1R-110117	11/1/2017	1521	5	484.85	NM	20.4	6.96	0.908	0.23	-112.7	3.34
	106EX2-P1P-111617	11/16/2017	1355	12	481.65	NM	20.3	7.04	0.945	0.49	-112.1	2.78
	106EX2-P1P-112917	11/29/2017	1326	12	480.40	NM	20.1	6.99	0.999	0.17	-103.7	3.17
	106EX2-P2R-011018	1/10/2018	1105	2	486.17	NM	19.9	7.02	0.937	0.11	-107.8	3.15
	106EX2-P2R-011618	1/16/2018	1250	6	486.40	NM	19.6	6.99	0.918	0.28	-118.8	3.61
	106EX2-P2R-012518	1/25/2018	1345	4.5	486.60	NM	20.1	6.90	0.946	0.29	-123.1	3.10
	106EX2-P2P-030718	3/7/2018	1515	7	485.50	NM	19.9	6.80	1.050	1.50	-127.3	3.22
	106EX2-P2P-041118	4/11/2018	1531	5	486.00	NM	20.6	6.74	1.142	0.29	-152.2	14.0
	106EX2-P2P-050918	5/9/2018	1355	7	484.98	NM	20.6	6.72	1.174	0.32	-142.2	5.81
	106EX2-P2P-061418	6/14/2018	1526	10	484.30	NM	21.1	6.85	1.131	0.05	-102.2	8.88
	106EX2-P3R-080818	8/8/2018	1235	5	487.00	NM	21.0	6.92	1.017	0.08	-81.6	6.92
	106EX2-P3R-081618	8/16/2018	1235	7	487.50	NM	21.0	6.88	1.032	0.13	-118.1	1.57
	106EX2-P3R-082218	8/22/2018	1205	7	487.50	NM	21.0	6.97	1.053	0.13	-117.0	2.09
	106EX2-P3R-082918	8/29/2018	1215	8	487.50	NM	21.2	6.87	1.044	0.26	-121.4	8.95
	106EX2-P3P-091218	9/12/2018	1355	8	478.54	NM	22.0	6.93	1.061	0.35	-155.4	4.35
	106EX2-P3P-100418	10/4/2018	1525	8	474.98	NM	21.6	6.83	1.089	0.24	-112.7	7.98
	106EX2-P3P-111918	11/19/2018	1440	8	474.61	NM	20.1	6.91	1.047	0.45	-93.3	3.22
106EX2-P4P-012119	1/21/2019	1305	8	479.02	NM	19.4	6.99	1.154	0.29	-126.7	2.28	
106EX2-LTM-081220	8/12/2020	1050	1.8	466.38	466.30	23.8	6.87	1.061	0.77	-82.1	5.64	
106EX2-LTM-101520	10/15/2020	1210	1.3	467.20	NA	22.6	6.88	1.316	3.18	-10.0	26.3	

**Table 3
Field Water Quality Measurements**

Location Name	Sample No.	Date	Time	Gallons Removed	Depth to Groundwater (feet below TOC) ^a	Depth to NAPL (feet below TOC) ^a	Temperature (°C)	pH (S.U.)	Specific Conductivity (mS/cm ²)	DO (mg/L)	ORP (mV)	Turbidity (NTU)	
KAFB-106IN1	106IN1-BL-062917	6/29/2017	0815	NR	476.10	NM	19.4	7.20	0.738	0.79	-110.6	17.8	
	106IN1-BL-092617	9/26/2017	1105	90	477.22	NM	21.1	7.00	0.736	0.27	-179.7	2.78	
	106IN1-P1P-111617	11/16/2017	1100	117	477.15	NM	22.4	6.94	0.937	0.04	-225.1	19.2	
	106IN1-P1P-112917	11/29/2017	1055	110	477.35	NM	22.1	6.86	0.934	0.16	-180.9	15.9	
	106IN1-P2P-030718	3/7/2018	1343	268	479.90	NM	23.5	6.34	1.750	0.25	-225.4	63.8	
	106IN1-P2P-041118	4/11/2018	1355	185	477.63	NM	24.8	6.50	1.744	0.24	-261.6	50.3	
	106IN1-P2P-050918	5/9/2018	1235	150	478.96	NM	24.7	6.63	0.846	0.26	-257.2	36.3	
	106IN1-P2P-061418	6/14/2018	1310	220	477.59	NM	24.8	6.76	1.701	0.04	-219.5	36.1	
	106IN1-P3P-100418 ^b	10/4/2018	NA	NA	475.35	NM	NM	NM	NM	NM	NM	NM	NM
	106IN1-P3P-111918 ^b	11/19/2018	NA	NA	474.51	NM	NM	NM	NM	NM	NM	NM	NM
	106IN1-P4P-012119 ^b	1/21/2019	NA	NA	473.60	NM	NM	NM	NM	NM	NM	NM	NM
	106IN1-LTM-031220	3/12/2020	1540	6.4	468.29	NA	17.5	7.03	3.707	0.12	-132.1	93.8	
	106IN1-LTM-051920	5/19/2020	1435	5.2	467.55	NA	20.4	7.01	3.950	0.08	-215.5	72.0	
	106IN1-LTM-080420	8/4/2020	1000	4.0	477.90	NA	19.7	7.10	3.940	0.16	-195.8	62.3	
106IN1-LTM-102820	10/28/2020	1218	7.4	470.90	NA	17.2	7.10	3.162	0.00	-136.6	99.8		

Notes:

^a Depth to Groundwater and non-aqueous phase liquid (NAPL) measurements were collected prior to purging (static) and during purging activities. The level included in this table represents the level collected just before sampling. Groundwater and NAPL measurements could not be obtained from nested intermediate wells (KAFB-106MW1-I and KAFB-106MW2-I) with the dedicated bladder pump downhole since the diameter of the well was too small. Additionally, groundwater and NAPL measurements could not be obtained from KAFB-106MW2-S due to an obstruction in the well casing. Groundwater level measurements from the extraction and injection wells were obtained from the downhole transducers during sampling activities.

* DO probe produced erroneous readings.

^bSample was collected from sound tube using a stainless steel bailer.

°C - degrees Celcius.

DO - Dissolved oxygen.

KAFB - Kirtland Air Force Base.

mg/L - Milligram per liter.

mS/cm² - Millisiemens per square centimeter.

mV - Millivolts.

NA - Not applicable. For NAPL measurements, this indicates there is no measurable product in the well.

NM - Not measured due to tubing obstruction or diameter of the well.

No. - Number.

NR - Not recorded.

NTU - Nephelometric Turbidity Unit.

S.U. - Standard Unit.

TOC - Top of casing.

	Baseline (Phase 1)
	Recirculation
	Passive

Table 4
Groundwater Sampling Frequency, Locations, and Analytes

Phase	Analyte	Locations ^a	Frequency
Phase 1	Water Isotopes ($\delta^2\text{H}$) (IRMS) and Dye Tracer (Fluorescein) (Fluorimetric)	6 MWs, 2 EWs, 1 IW	1 event (baseline)
		6 MWs, 2 EWs	8 events (recirculation, collected on Days 2, 4, 7, 10, 14, 18, 23, and 30)
		6 MWs, 2 EWs, 1 IW	2 events (passive, collected during Weeks 2 and 4)
	Microbial Community (QuantArray-Chlor)	6 MWs, 2 EWs, 1 IW	1 event (baseline)
		6 MWs, 2 EWs, 1 IW	1 event (passive, collected during Week 4)
	CSIA (Kuder et al, 2012)	3 MWs ^c , 2EWs, 1 IW	1 event (baseline)
		3 MWs ^c , 2EWs, 1 IW	1 event (passive, collected during Week 4)
	All Other Analytes ^b	6 MWs, 2 EWs, 1 IW	1 event (baseline)
		6 MWs, 2 EWs	8 events (recirculation, collected on Days 2, 4, 7, 10, 14, 18, 23, and 30)
6 MWs, 2 EWs, 1 IW		2 events (passive, collected during Weeks 2 and 4)	
Phase 2	Microbial Community (QuantArray-Chlor)	6 MWs, 2 EWs	1 event (recirculation, collected during Week 4)
		6 MWs, 2 EWs, 1 IW	1 event (passive, collected at end of Month 3)
	CSIA (Kuder et al, 2012)	3 MWs ^c , 2EWs, 1 IW	1 event (recirculation, collected during Week 4)
		3 MWs ^c , 2EWs, 1 IW	1 event (passive, collected at end of Month 3)
	All Other Analytes ^b	6 MWs, 2 EWs	3 events (recirculation, collected during Weeks 2, 3, and 4)
		6 MWs, 2 EWs, 1 IW	4 events (passive, collected at end of Months 1, 2, 3, and 4) ^d
Phase 3	Microbial Community (QuantArray-Chlor)	6 MWs, 2 EWs	1 event (recirculation, collected during Week 4)
		6 MWs, 2 EWs, 1 IW	1 event (passive, collected at end of Month 3)
	CSIA (Kuder et al, 2012)	3 MWs ^c , 2EWs, 1 IW	1 event (recirculation, collected during Week 4)
		3 MWs ^c , 2EWs, 1 IW	1 event (passive, collected at end of Month 3)
	All Other Analytes ^b	6 MWs, 2 EWs	4 events (recirculation, collected during Weeks 2, 3, 4, and 5) ^e
		6 MWs, 2 EWs, 1 IW	3 events (passive, collected at end of Months 1, 2, and 3)
Phase 4	Microbial Community (QuantArray-Chlor)	6 MWs, 2 EWs, 1 IW	1 event (passive, collected at the end of Month 2)
	CSIA (Kuder et al, 2012)	3 MWs ^c , 2EWs, 1 IW	1 event (passive, collected at the end of Month 2)
	All Other Analytes ^b	6 MWs, 2 EWs, 1 IW	1 event (passive, collected at the end of Month 2)
Phase 4 ^f	Microbial Community (QuantArray-Chlor)	6 MWs, 2 EWs, 1 IW	4 events (passive, quarterly beginning in 2020)
	All Other Analytes ^g	6 MWs, 2 EWs, 1 IW	4 events (passive, quarterly beginning in 2020)

Notes:

Kuder, T., Wilson J.T., Philip, P., He, Y.T., 2012. Carbon Isotope Fractionation in Reactions of 1,2 Dibromoethane with FeS and Hydrogen Sulfide. Environ. Sci. Technol. 46, 7495-7502.

Table 4 Groundwater Sampling Frequency, Locations, and Analytes

^a 4 MWs = KAFB-106064, KAFB-106063, KAFB-106MW1-S, KAFB-106MW1-I, KAFB-106MW2-S, KAFB-106MW2-I

2 EWs = KAFB-106EX1 and KAFB-106EX2

1 IW = KAFB-106IN1

^b EDB (EPA Method 8011), VOCs (EPA Method 8260B), reduced gases (RSK-175), anions (E353.2, SM4500PE, and SW9056A), VFAs (E300M), dissolved iron and manganese (EPA Method 6010C), and alkalinity (SM2320B).

^c Includes shallow monitoring wells KAFB-106064, KAFB-106MW1-S, and KAFB-106MW2-S.

^d An additional sampling event was conducted at the end of the passive phase (Month 4).

^e An additional sampling event was conducted at the end of recirculation (Week 5).

^f Quarterly Phase 4 sampling was initiated in March 2020 and continued through October 2020. Extraction well KAFB-106EX2 was not sampled during first and second quarter 2020 due to the presence of NAPL in the well.

^g EDB (EPA Method 8011), VOCs (EPA Method 8260C), reduced gases (RSK-175; EPA 3810), anions (EPA Method 300.0, EPA Method 365.3, and SM4500PE), VFAs (EPA Method 300M), dissolved iron and manganese (EPA Method 6020A), total lead (EPA Method 6020A), and alkalinity (SM2320B).

CSIA - Compound-Specific Isotope Analysis.

EDB - Ethylene dibromide.

EPA - U.S. Environmental Protection Agency.

EW - Extraction well.

IRMS - Isotope Ratio Mass Spectrometry.

IW - Injection well.

KAFB - Kirtland Air Force Base.

Microbial Community - Microorganism population.

MW - Monitoring well.

NAPL - Non-aqueous phase liquid.

VFA - Volatile Fatty Acid.

VOCs - Volatile organic compound.

Table 5
Manual Extraction Well Water Level Measurements

Well ID	Phase	Date ^a	Depth to Water (feet below TOC)	Drawdown (feet) ^b	Flow Rate (gpm)
KAFB-106EX1	1	6/29/2017	476.20	NA	NA
		10/17/2017	482.58	-6.38	10
		10/23/2017	483.25	-7.05	10
		10/31/2017	483.40	-7.20	10
	2	11/29/2017 (Static)	475.97	NA	NA
		12/13/2017	481.28	-5.31	10
		12/15/2017	481.61	-5.64	10
		12/20/2017	481.64	-5.67	10
		12/22/2017	481.58	-5.61	10
		12/27/2017	481.77	-5.80	10
		1/2/2018	481.71	-5.74	10
		1/4/2018	481.80	-5.83	10
		1/8/2018	481.90	-5.93	10
		1/10/2018	481.41	-5.44	10
		1/12/2018	482.12	-6.15	10
		1/15/2018	480.47	-4.50	10
		1/17/2018	480.90	-4.93	10
		1/19/2018	480.62	-4.65	10
		1/22/2018	480.61	-4.64	10
		1/30/2018	480.52	-4.55	10
3	6/14/2018 (Static)	474.78	NA	NA	
	7/30/2018	479.46	-4.68	10	
	8/6/2018	480.11	-5.33	10	
	8/13/2018	480.06	-5.28	10	
	8/21/2018	480.33	-5.55	10	
KAFB-106EX2	1	6/29/2017	476.70	NA	NA
		10/17/2017	483.69	-6.99	10
		10/23/2017	484.36	-7.66	10
		10/31/2017	484.85	-8.15	10
	2	11/29/2017 (Static)	475.93	NA	NA
		12/13/2017	484.53	-8.60	10
		12/15/2017	485.02	-9.09	10
		12/20/2017	485.34	-9.41	10
		12/22/2017	485.40	-9.47	10
		12/27/2017	485.94	-10.01	10
		12/29/2017	486.05	-10.12	10
		1/2/2018	486.14	-10.21	10
		1/4/2018	486.24	-10.31	10
		1/8/2018	486.68	-10.75	9
		1/10/2018	486.17	-10.24	9
1/12/2018	486.73	-10.80	8		
1/15/2018	486.41	-10.48	8		

Table 5
Manual Extraction Well Water Level Measurements

Well ID	Phase	Date ^a	Depth to Water (feet below TOC)	Drawdown (feet) ^b	Flow Rate (gpm)
KAFB-106EX2	2	1/17/2018	486.73	-10.80	8
		1/19/2018	486.61	-10.68	8
		1/22/2018	486.43	-10.50	7
		1/24/2018	486.65	-10.72	7
		1/26/2018	486.65	-10.72	7
		1/30/2018	486.89	-10.96	7
	3	6/14/2018 (Static)	474.34	NA	NA
		7/30/2018	487.07	-12.73	7
		7/31/2018	487.25	-12.91	7
		8/1/2018	487.35	-13.01	7
		8/2/2018	487.34	-13.00	7
		8/6/2018	487.32	-12.98	6
		8/7/2018	487.37	-13.03	6
		8/8/2018	487.50	-13.16	6
		8/9/2018	487.54	-13.20	6
		8/10/2018	487.66	-13.32	6
		8/13/2018	487.51	-13.17	6
		8/14/2018	487.54	-13.20	6
		8/16/2018	487.51	-13.17	5
		8/20/2018	487.52	-13.18	5
		8/21/2018	487.52	-13.18	5
		8/23/2018	487.55	-13.21	5
		8/30/2018	487.36	-13.02	4
9/4/2018	487.42	-13.08	4		

Notes:

^a Only dates in which water levels were measured during active recirculation are included.

^b Drawdown is determined by subtracting the static water level measured during the previous passive Phase from the water level measured during the active recirculation (pumping) Phase.

gpm - Gallons per minute.

ID - Identification.

KAFB - Kirtland Air Force Base.

TOC - Top of casing.

**Table 6
Amendment Batching Summary**

Batch #	Date	Phase	DAP (kg)	KI (kg)	Wilclear Plus® Lactate (gallons)	Potable Water (gallons)	Notes
1	12/22/2017	2	127	33	135	315	Stopped injecting on 12/23/17 due to crystallization issues in chemical feed pump. Removed 150 gallons of batch 1 mixture from tank, and added 150 gallons of water on 12/28. Resumed injection of amendments on 12/29/17 at 0806. Diluted the remaining stored 150 gallons of mixture with 75 gallons of water, and added the 225 gallons to the tank on 1/2/18.
	1/4/2018		0	12	50	200	Mounding increases, decide to add less DAP. Removed 200 gallons of amendment mixture from tank and store in tote to accommodate this batch without DAP. Brought tank level up to ~450 gallons. Start injecting new mixture on 1/5/18 at 0820.
	1/11/2018		0	6	25	100	Also added 100 gallons of diluted mixture that was previously removed from tank on 1/4 (prior to mixing batch 2). Brought tank level up to ~450 gallons. Used same ratio as 1/4/18 mix.
	1/15/2018		0	6	25	100	Also added 100 gallons of diluted mixture that was previously removed from tank on 1/4/18 (prior to mixing batch 2). Brought tank level up to ~510 gallons. Used same ratio as 1/4/18 mix.
2	1/23/2018		23	14	55	220	Brought tank level up from 175 to 450 gallons. Finish Phase 2 injection on 2/3/18 at 1130. Inject remaining 11 gallons of amendment and flush injection well for 1 hour at 17 gpm on 2/7/18. System off at 1725.
3	7/30/2018	3	38	0	90	360	Brought tank level up to 450 gallons. Start injection on 7/30/18 at 1504.
4	8/6/2018		29	0	70	280	Brought tank level up to 500 gallons. Resume injection on 8/6/18 at 1539.
5	8/14/2018		26	0	62	248	Level was at 190 gallons, needed 310 gallons to bring level up to 500. Resume injection on 8/14/18 at 1453.
6	8/23/2018		28	0	66	264	Resume injection on 8/23/18 at 1431.
7	8/30/2018		22	0	52	208	Resume injection on 8/30/18 at 1301. Finish Phase 3 injection on 9/9/18 at 1525. Flush injection well for approximately 1 hour.
TOTAL			293	71	630	2,295	

Notes:

- Number.

DAP - Diammonium phosphate.

kg - Kilogram.

KI - Potassium iodide.

Table 7
Analytical Data Table for KAFB-106063

Phase Designation		Original Baseline ^b			New Baseline - QED Pumps ^c			Phase 1 Recirculation		
Sample ID		106063-BL-071817			106063-BL-091817			106063-P1R-100417		
Sample Date		7/18/2017			9/18/2017			10/4/2017		
Sample Purpose		REG			REG			REG		
Chemical Class and Analytical Method ^a	Parameter	Result	Val Qual	LOQ	Result	Val Qual	LOQ	Result	Val Qual	LOQ
Microbial Community (cells/mL) QuantArray-Chlor	1,1 DCA Reductase (DCA)	ND	U	4.8	NS	--	--	NS	--	--
	1,2 DCA Reductase (DCAR)	ND	U	4.8	NS	--	--	NS	--	--
	BAV1 Vinyl Chloride Reductase (BVC)	ND	U	0.5	NS	--	--	NS	--	--
	Chloroform Reductase (CFR)	ND	U	4.8	NS	--	--	NS	--	--
	Dehalobacter DCM (DCM)	ND	U	4.8	NS	--	--	NS	--	--
	Dehalobacter spp. (DHBt)	5950		4.8	NS	--	--	NS	--	--
	Dehalobium chlorocoercia (DECO)	1120		4.8	NS	--	--	NS	--	--
	Dehalococcoides (DHC)	ND	U	0.5	NS	--	--	NS	--	--
	Dehalogenimonas spp. (DHG)	ND	U	4.8	NS	--	--	NS	--	--
	Desulfitobacterium spp. (DSB)	316		4.8	NS	--	--	NS	--	--
	Desulfuromonas spp. (DSM)	ND	U	4.8	NS	--	--	NS	--	--
	Dichloromethane Dehalogenase (DCMA)	ND	U	4.8	NS	--	--	NS	--	--
	Epoxyalkane Transferase (EtnE)	261		4.8	NS	--	--	NS	--	--
	Ethene Monooxygenase (EtnC)	9.5		4.8	NS	--	--	NS	--	--
	Methanogens (MGN)	118		4.8	NS	--	--	NS	--	--
	PCE Reductase (PCE-1)	NS	--	--	NS	--	--	NS	--	--
	Phenol Hydroxylase (PHE)	11300		4.8	NS	--	--	NS	--	--
	PMMO	136		4.8	NS	--	--	NS	--	--
	Soluble Methane Monooxygenase (SMMO)	639		4.8	NS	--	--	NS	--	--
	Sulfate Reducing Bacteria (APS)	69100		4.8	NS	--	--	NS	--	--
	TceA Reductase (TCE)	ND	U	0.5	NS	--	--	NS	--	--
	Toluene Dioxygenase (TOD)	113		4.8	NS	--	--	NS	--	--
	Toluene Monooxygenase (RMO)	19200		4.8	NS	--	--	NS	--	--
	Toluene Monooxygenase 2 (RDEG)	9950		4.8	NS	--	--	NS	--	--
	Total Eubacteria (EBAC)	1090000		4.8	NS	--	--	NS	--	--
trans-1,2-DCE Reductase (TDR)	ND	U	4.8	NS	--	--	NS	--	--	
Trichlorobenzene Dioxygenase (TCBO)	0.5	J	4.8	NS	--	--	NS	--	--	
Vinyl Chloride Reductase (VCR)	ND	U	0.5	NS	--	--	NS	--	--	
EDB (µg/L) EPA Method 8011	1,2-DIBROMOETHANE	ND	UJ	0.0188	ND	UJ	0.0194	NS	--	--
VFAs (mg/L) EPA Method 300m	ACETIC ACID	ND	U	1	0.63	J	1	NS	--	--
	BUTYRIC ACID	ND	U	1	ND	U	1	NS	--	--
	FORMIC ACID	ND	U	1	ND	U	1	NS	--	--
	LACTIC ACID	ND	U	1	ND	U	1	NS	--	--
	PROPIONIC ACID	ND	U	1	ND	U	1	NS	--	--
	PYRUVIC ACID	ND	U	1	ND	U	1	NS	--	--
Fluorometric (µg/L) Spectrofluorophotometry	VALERIC ACID	ND	U	1	ND	U	1	NS	--	--
	FLUORESCCEIN	ND	U	0.01	ND	U	0.01	ND	U	0.01
Reduced Gases (µg/L) RSKSOP-175	ACETYLENE	ND	U	10	ND	U	10	NS	--	--
	ETHANE	ND	U	4	ND	U	4	NS	--	--
	ETHYLENE	ND	U	5	ND	U	5	NS	--	--
	METHANE	ND	U	2	ND	U	2	NS	--	--
	PROPANE	ND	U	6	ND	U	6	NS	--	--

Table 7
Analytical Data Table for KAFB-106063

Phase Designation		Original Baseline ^b			New Baseline - QED Pumps ^c			Phase 1 Recirculation		
Sample ID		106063-BL-071817			106063-BL-091817			106063-P1R-100417		
Sample Date		7/18/2017			9/18/2017			10/4/2017		
Sample Purpose		REG			REG			REG		
Chemical Class and Analytical Method ^a	Parameter	Result	Val Qual	LOQ	Result	Val Qual	LOQ	Result	Val Qual	LOQ
General Chemistry (mg/L) SM2320b, EPA Method 300, EPA Method 353.2, SM4500 PE ^c	ALKALINITY	206		1	311		1	NS	--	--
	BROMIDE	0.178		0.125	0.165		0.125	NS	--	--
	CHLORIDE	15.7		0.33	13.3		0.33	NS	--	--
	IODIDE	ND	U	0.2	ND	U	0.75	NS	--	--
	NITRATE	NA	--	--	NA	--	--	NS	--	--
	NITRITE	NA	--	--	NA	--	--	NS	--	--
	NITROGEN, NITRATE-NITRITE	ND	U	0.375	ND	U	0.375	NS	--	--
	O-PHOSPHATE (AS P)	ND	U	0.02	ND	U	0.02	NS	--	--
	ORTHOPHOSPHATE	NA	--	--	NA	--	--	NS	--	--
PHOSPHORUS	NA	--	--	NA	--	--	NS	--	--	
SULFATE	16.2		1	16.4		1	NS	--	--	
Metals (mg/L) EPA Method 6010	LEAD	NS	--	--	NS	--	--	NS	--	--
Dissolved Metals (mg/L) EPA Method 6010	IRON	0.054		0.06	0.193		0.06	NS	--	--
	MANGANESE	0.308		0.006	0.438		0.006	NS	--	--
δ2H (‰) Mass Spectrometry, USGS Reston, VA	DELTA2H	-96.01		-99	-95.56		-99	-94.59		-99
VOCs (µg/L) EPA Method 8260	1,1,2-TRICHLOROETHANE	ND	U	1	ND	U	1	NS	--	--
	1,2,4-TRICHLOROBENZENE	NA	--	--	NA	--	--	NS	--	--
	1,2,4-TRIMETHYLBENZENE	ND	U	1	ND	U	1	NS	--	--
	1,2-DIBROMOETHANE	ND	U	1	ND	U	1	NS	--	--
	1,2-DICHLOROETHANE	ND	U	1	1.86	J	1	NS	--	--
	1,3,5-TRIMETHYLBENZENE	ND	U	1	ND	U	1	NS	--	--
	2-BUTANONE	ND	U	10	ND	U	10	NS	--	--
	2-CHLOROTOLUENE	ND	U	1	ND	U	1	NS	--	--
	2-HEXANONE	ND	U	5	ND	U	5	NS	--	--
	4-METHYL-2-PENTANONE	ND	U	5	ND	U	5	NS	--	--
	ACETONE	31.8		10	16.1	J	10	NS	--	--
	BENZENE	ND	U	1	ND	U	1	NS	--	--
	CARBON DISULFIDE	ND	U	1	ND	U	1	NS	--	--
	CHLOROMETHANE	ND	U	1	ND	U	1	NS	--	--
	CIS-1,2-DICHLOROETHENE	NA	--	--	NA	--	--	NS	--	--
	DICHLORODIFLUOROMETHANE	ND	U	2	ND	U	2	NS	--	--
	ETHYLBENZENE	ND	U	1	ND	U	1	NS	--	--
	ISOPROPYLBENZENE	ND	U	1	ND	U	1	NS	--	--
	M,P-XYLENES	NA	--	--	NA	--	--	NS	--	--
	METHYL TERT-BUTYL ETHER	ND	U	1	0.561	J	1	NS	--	--
	METHYLENE CHLORIDE	ND	U	2	ND	U	2	NS	--	--
	NAPHTHALENE	ND	U	1	ND	U	1	NS	--	--
	N-BUTYLBENZENE	ND	U	1	ND	U	1	NS	--	--
	N-PROPYLBENZENE	ND	U	1	ND	U	1	NS	--	--
	O-XYLENE	NA	--	--	NA	--	--	NS	--	--
	P-ISOPROPYLTOLUENE	ND	U	1	ND	U	1	NS	--	--
	SEC-BUTYLBENZENE	ND	U	1	ND	U	1	NS	--	--
	TERT-BUTYLBENZENE	ND	U	1	ND	U	1	NS	--	--
	TETRACHLOROETHENE	NA	--	--	NA	--	--	NS	--	--
	TOLUENE	ND	U	1	ND	U	1	NS	--	--
	TRANS-1,2-DICHLOROETHENE	NA	--	--	NA	--	--	NS	--	--
	TRICHLOROETHENE	ND	U	1	ND	U	1	NS	--	--
TRICHLOROFLUOROMETHANE	ND	U	2	ND	U	2	NS	--	--	
VINYL CHLORIDE	NA	--	--	NA	--	--	NS	--	--	
XYLENES	ND	U	3	ND	U	3	NS	--	--	

Refer to notes at the end of the table.

Table 7
Analytical Data Table for KAFB-106063

Phase Designation		Phase 1 Recirculation						Phase 1 Recirculation					
Sample ID		106063-P1R-100617			106063-P1R-100917			106063-P1R-101217			106063-P1R-101617		
Sample Date		10/6/2017			10/9/2017			10/12/2017			10/16/2017		
Sample Purpose		REG			REG			REG			REG		
Chemical Class and Analytical Method ^a	Parameter	Result	Val Qual	LOQ	Result	Val Qual	LOQ	Result	Val Qual	LOQ	Result	Val Qual	LOQ
Microbial Community (cells/mL) QuantArray-Chlor	1,1 DCA Reductase (DCA)	NS	--	--	NS	--	--	NS	--	--	NS	--	--
	1,2 DCA Reductase (DCAR)	NS	--	--	NS	--	--	NS	--	--	NS	--	--
	BAV1 Vinyl Chloride Reductase (BVC)	NS	--	--	NS	--	--	NS	--	--	NS	--	--
	cer A Reductase	NS	--	--	NS	--	--	NS	--	--	NS	--	--
	Chloroform Reductase (CFR)	NS	--	--	NS	--	--	NS	--	--	NS	--	--
	Dehalobacter DCM (DCM)	NS	--	--	NS	--	--	NS	--	--	NS	--	--
	Dehalobacter spp. (DHBt)	NS	--	--	NS	--	--	NS	--	--	NS	--	--
	Dehalobium chlorocoercia (DECO)	NS	--	--	NS	--	--	NS	--	--	NS	--	--
	Dehalococcoides (DHC)	NS	--	--	NS	--	--	NS	--	--	NS	--	--
	Dehalogenimonas spp. (DHG)	NS	--	--	NS	--	--	NS	--	--	NS	--	--
	Desulfitobacterium spp. (DSB)	NS	--	--	NS	--	--	NS	--	--	NS	--	--
	Desulfuromonas spp. (DSM)	NS	--	--	NS	--	--	NS	--	--	NS	--	--
	Dichloromethane Dehalogenase (DCMA)	NS	--	--	NS	--	--	NS	--	--	NS	--	--
	Epoxyalkane Transferase (EtnE)	NS	--	--	NS	--	--	NS	--	--	NS	--	--
	Ethene Monooxygenase (EtnC)	NS	--	--	NS	--	--	NS	--	--	NS	--	--
	Methanogens (MGN)	NS	--	--	NS	--	--	NS	--	--	NS	--	--
	PCE Reductase (PCE-1)	NS	--	--	NS	--	--	NS	--	--	NS	--	--
	Phenol Hydroxylase (PHE)	NS	--	--	NS	--	--	NS	--	--	NS	--	--
	PMMO	NS	--	--	NS	--	--	NS	--	--	NS	--	--
	Soluble Methane Monooxygenase (SMMO)	NS	--	--	NS	--	--	NS	--	--	NS	--	--
	Sulfate Reducing Bacteria (APS)	NS	--	--	NS	--	--	NS	--	--	NS	--	--
	tceA Reductase (TCE)	NS	--	--	NS	--	--	NS	--	--	NS	--	--
	Toluene Dioxygenase (TOD)	NS	--	--	NS	--	--	NS	--	--	NS	--	--
	Toluene Monooxygenase (RMO)	NS	--	--	NS	--	--	NS	--	--	NS	--	--
Toluene Monooxygenase 2 (RDEG)	NS	--	--	NS	--	--	NS	--	--	NS	--	--	
Total Eubacteria (EBAC)	NS	--	--	NS	--	--	NS	--	--	NS	--	--	
trans-1,2-DCE Reductase (TDR)	NS	--	--	NS	--	--	NS	--	--	NS	--	--	
Trichlorobenzene Dioxygenase (TCBO)	NS	--	--	NS	--	--	NS	--	--	NS	--	--	
Vinyl Chloride Reductase (VCR)	NS	--	--	NS	--	--	NS	--	--	NS	--	--	
EDB (µg/L) EPA Method 8011	1,2-DIBROMOETHANE	NS	--	--	NS	--	--	NS	--	--	NS	--	--
VFAs (mg/L) EPA Method 300m	ACETIC ACID	NS	--	--	NS	--	--	NS	--	--	NS	--	--
	BUTYRIC ACID	NS	--	--	NS	--	--	NS	--	--	NS	--	--
	FORMIC ACID	NS	--	--	NS	--	--	NS	--	--	NS	--	--
	LACTIC ACID	NS	--	--	NS	--	--	NS	--	--	NS	--	--
	PROPIONIC ACID	NS	--	--	NS	--	--	NS	--	--	NS	--	--
	PYRUVIC ACID	NS	--	--	NS	--	--	NS	--	--	NS	--	--
	VALERIC ACID	NS	--	--	NS	--	--	NS	--	--	NS	--	--
Fluorometric (µg/L) Spectrofluorophotometry	FLUORESCIEIN	ND	U	0.01	ND	U	0.01	ND	U	0.01	ND	U	0.01
Reduced Gases (µg/L) RSKSOP-175	ACETYLENE	NS	--	--	NS	--	--	NS	--	--	NS	--	--
	ETHANE	NS	--	--	NS	--	--	NS	--	--	NS	--	--
	ETHYLENE	NS	--	--	NS	--	--	NS	--	--	NS	--	--
	METHANE	NS	--	--	NS	--	--	NS	--	--	NS	--	--
	PROPANE	NS	--	--	NS	--	--	NS	--	--	NS	--	--

Table 7
Analytical Data Table for KAFB-106063

Phase Designation		Phase 1 Recirculation						Phase 1 Recirculation					
Sample ID		106063-P1R-100617			106063-P1R-100917			106063-P1R-101217			106063-P1R-101617		
Sample Date		10/6/2017			10/9/2017			10/12/2017			10/16/2017		
Sample Purpose		REG			REG			REG			REG		
Chemical Class and Analytical Method ^a	Parameter	Result	Val Qual	LOQ	Result	Val Qual	LOQ	Result	Val Qual	LOQ	Result	Val Qual	LOQ
General Chemistry (mg/L) SM2320b, EPA Method 300, EPA Method 353.2, SM4500 PE ^c	ALKALINITY	NS	--	--	NS	--	--	NS	--	--	NS	--	--
	BROMIDE	NS	--	--	NS	--	--	NS	--	--	NS	--	--
	CHLORIDE	NS	--	--	NS	--	--	NS	--	--	NS	--	--
	IODIDE	NS	--	--	NS	--	--	NS	--	--	NS	--	--
	NITRATE	NS	--	--	NS	--	--	NS	--	--	NS	--	--
	NITRITE	NS	--	--	NS	--	--	NS	--	--	NS	--	--
	NITROGEN, NITRATE-NITRITE	NS	--	--	NS	--	--	NS	--	--	NS	--	--
	O-PHOSPHATE (AS P)	NS	--	--	NS	--	--	NS	--	--	NS	--	--
	ORTHOPHOSPHATE	NS	--	--	NS	--	--	NS	--	--	NS	--	--
	PHOSPHORUS	NS	--	--	NS	--	--	NS	--	--	NS	--	--
SULFATE	NS	--	--	NS	--	--	NS	--	--	NS	--	--	
Metals (mg/L) EPA Method 6010	LEAD	NS	--	--	NS	--	--	NS	--	--	NS	--	--
Dissolved Metals (mg/L) EPA Method 6010	IRON	NS	--	--	NS	--	--	NS	--	--	NS	--	--
	MANGANESE	NS	--	--	NS	--	--	NS	--	--	NS	--	--
δ2H (‰) Mass Spectrometry, USGS Reston, VA	DELTA2H	-96.02		-99	-95.95		-99	-95.92		-99	-96.05		-99
VOCs (µg/L) EPA Method 8260	1,1,2-TRICHLOROETHANE	NS	--	--	NS	--	--	NS	--	--	NS	--	--
	1,2,4-TRICHLOROBENZENE	NS	--	--	NS	--	--	NS	--	--	NS	--	--
	1,2,4-TRIMETHYLBENZENE	NS	--	--	NS	--	--	NS	--	--	NS	--	--
	1,2-DIBROMOETHANE	NS	--	--	NS	--	--	NS	--	--	NS	--	--
	1,2-DICHLOROETHANE	NS	--	--	NS	--	--	NS	--	--	NS	--	--
	1,3,5-TRIMETHYLBENZENE	NS	--	--	NS	--	--	NS	--	--	NS	--	--
	2-BUTANONE	NS	--	--	NS	--	--	NS	--	--	NS	--	--
	2-CHLOROTOLUENE	NS	--	--	NS	--	--	NS	--	--	NS	--	--
	2-HEXANONE	NS	--	--	NS	--	--	NS	--	--	NS	--	--
	4-METHYL-2-PENTANONE	NS	--	--	NS	--	--	NS	--	--	NS	--	--
	ACETONE	NS	--	--	NS	--	--	NS	--	--	NS	--	--
	BENZENE	NS	--	--	NS	--	--	NS	--	--	NS	--	--
	CARBON DISULFIDE	NS	--	--	NS	--	--	NS	--	--	NS	--	--
	CHLOROMETHANE	NS	--	--	NS	--	--	NS	--	--	NS	--	--
	CIS-1,2-DICHLOROETHENE	NS	--	--	NS	--	--	NS	--	--	NS	--	--
	DICHLORODIFLUOROMETHANE	NS	--	--	NS	--	--	NS	--	--	NS	--	--
	ETHYLBENZENE	NS	--	--	NS	--	--	NS	--	--	NS	--	--
	ISOPROPYLBENZENE	NS	--	--	NS	--	--	NS	--	--	NS	--	--
	M,P-XYLENES	NS	--	--	NS	--	--	NS	--	--	NS	--	--
	METHYL TERT-BUTYL ETHER	NS	--	--	NS	--	--	NS	--	--	NS	--	--
	METHYLENE CHLORIDE	NS	--	--	NS	--	--	NS	--	--	NS	--	--
	NAPHTHALENE	NS	--	--	NS	--	--	NS	--	--	NS	--	--
	N-BUTYLBENZENE	NS	--	--	NS	--	--	NS	--	--	NS	--	--
	N-PROPYLBENZENE	NS	--	--	NS	--	--	NS	--	--	NS	--	--
	O-XYLENE	NS	--	--	NS	--	--	NS	--	--	NS	--	--
	P-ISOPROPYLTOLUENE	NS	--	--	NS	--	--	NS	--	--	NS	--	--
	SEC-BUTYLBENZENE	NS	--	--	NS	--	--	NS	--	--	NS	--	--
	TERT-BUTYLBENZENE	NS	--	--	NS	--	--	NS	--	--	NS	--	--
	TETRACHLOROETHENE	NS	--	--	NS	--	--	NS	--	--	NS	--	--
	TOLUENE	NS	--	--	NS	--	--	NS	--	--	NS	--	--
	TRANS-1,2-DICHLOROETHENE	NS	--	--	NS	--	--	NS	--	--	NS	--	--
	TRICHLOROETHENE	NS	--	--	NS	--	--	NS	--	--	NS	--	--
	TRICHLOROFUOROMETHANE	NS	--	--	NS	--	--	NS	--	--	NS	--	--
	VINYL CHLORIDE	NS	--	--	NS	--	--	NS	--	--	NS	--	--
XYLENES	NS	--	--	NS	--	--	NS	--	--	NS	--	--	

Refer to notes at the end of the table.

**Table 7
Analytical Data Table for KAFB-106063**

Phase Designation		Phase 1 Recirculation									Phase 1 Passive		
Sample ID		106063-P1R-102017			106063-P1R-102417			106063-P1R-110117			106063-P1P-111517		
Sample Date		10/20/2017			10/24/2017			11/1/2017			11/15/2017		
Sample Purpose		REG			REG			REG			REG		
Chemical Class and Analytical Method ^a	Parameter	Result	Val Qual	LOQ	Result	Val Qual	LOQ	Result	Val Qual	LOQ	Result	Val Qual	LOQ
Microbial Community (cells/mL) QuantArray-Chlor	1,1 DCA Reductase (DCA)	NS	--	--	NS	--	--	NS	--	--	NS	--	--
	1,2 DCA Reductase (DCAR)	NS	--	--	NS	--	--	NS	--	--	NS	--	--
	BAV1 Vinyl Chloride Reductase (BVC)	NS	--	--	NS	--	--	NS	--	--	NS	--	--
	cer A Reductase	NS	--	--	NS	--	--	NS	--	--	NS	--	--
	Chloroform Reductase (CFR)	NS	--	--	NS	--	--	NS	--	--	NS	--	--
	Dehalobacter DCM (DCM)	NS	--	--	NS	--	--	NS	--	--	NS	--	--
	Dehalobacter spp. (DHBt)	NS	--	--	NS	--	--	NS	--	--	NS	--	--
	Dehalobium chlorocoercia (DECO)	NS	--	--	NS	--	--	NS	--	--	NS	--	--
	Dehalococcoides (DHC)	NS	--	--	NS	--	--	NS	--	--	NS	--	--
	Dehalogenimonas spp. (DHG)	NS	--	--	NS	--	--	NS	--	--	NS	--	--
	Desulfitobacterium spp. (DSB)	NS	--	--	NS	--	--	NS	--	--	NS	--	--
	Desulfuromonas spp. (DSM)	NS	--	--	NS	--	--	NS	--	--	NS	--	--
	Dichloromethane Dehalogenase (DCMA)	NS	--	--	NS	--	--	NS	--	--	NS	--	--
	Epoxyalkane Transferase (EtnE)	NS	--	--	NS	--	--	NS	--	--	NS	--	--
	Ethene Monooxygenase (EtnC)	NS	--	--	NS	--	--	NS	--	--	NS	--	--
	Methanogens (MGN)	NS	--	--	NS	--	--	NS	--	--	NS	--	--
	PCE Reductase (PCE-1)	NS	--	--	NS	--	--	NS	--	--	NS	--	--
	Phenol Hydroxylase (PHE)	NS	--	--	NS	--	--	NS	--	--	NS	--	--
	PMMO	NS	--	--	NS	--	--	NS	--	--	NS	--	--
	Soluble Methane Monooxygenase (SMMO)	NS	--	--	NS	--	--	NS	--	--	NS	--	--
	Sulfate Reducing Bacteria (APS)	NS	--	--	NS	--	--	NS	--	--	NS	--	--
	tceA Reductase (TCE)	NS	--	--	NS	--	--	NS	--	--	NS	--	--
	Toluene Dioxygenase (TOD)	NS	--	--	NS	--	--	NS	--	--	NS	--	--
	Toluene Monooxygenase (RMO)	NS	--	--	NS	--	--	NS	--	--	NS	--	--
	Toluene Monooxygenase 2 (RDEG)	NS	--	--	NS	--	--	NS	--	--	NS	--	--
Total Eubacteria (EBAC)	NS	--	--	NS	--	--	NS	--	--	NS	--	--	
trans-1,2-DCE Reductase (TDR)	NS	--	--	NS	--	--	NS	--	--	NS	--	--	
Trichlorobenzene Dioxygenase (TCBO)	NS	--	--	NS	--	--	NS	--	--	NS	--	--	
Vinyl Chloride Reductase (VCR)	NS	--	--	NS	--	--	NS	--	--	NS	--	--	
EDB (µg/L) EPA Method 8011	1,2-DIBROMOETHANE	NS	--	--	ND	U	0.0191	NS	--	--	0.0105	J	0.019
VFAs (mg/L) EPA Method 300m	ACETIC ACID	NS	--	--	0.65	J	1	NS	--	--	1.29		1
	BUTYRIC ACID	NS	--	--	ND	U	1	NS	--	--	ND	U	1
	FORMIC ACID	NS	--	--	ND	U	1	NS	--	--	ND	U	1
	LACTIC ACID	NS	--	--	ND	U	1	NS	--	--	ND	U	1
	PROPIONIC ACID	NS	--	--	ND	U	1	NS	--	--	ND	U	1
	PYRUVIC ACID	NS	--	--	ND	U	1	NS	--	--	ND	U	1
	VALERIC ACID	NS	--	--	ND	U	1	NS	--	--	ND	U	1
Fluorometric (µg/L) Spectrofluorophotometry	FLUORESC EIN	ND	U	0.01	ND	U	0.01	ND	U	0.01	ND	U	0.01
Reduced Gases (µg/L) RSKSOP-175	ACETYLENE	NS	--	--	ND	U	10	NS	--	--	ND	U	10
	ETHANE	NS	--	--	ND	U	4	NS	--	--	ND	U	4
	ETHYLENE	NS	--	--	ND	U	5	NS	--	--	ND	U	5
	METHANE	NS	--	--	ND	U	2	NS	--	--	ND	U	2
	PROPANE	NS	--	--	ND	U	6	NS	--	--	ND	U	6

Table 7
Analytical Data Table for KAFB-106063

Phase Designation		Phase 1 Recirculation									Phase 1 Passive		
Sample ID		106063-P1R-102017			106063-P1R-102417			106063-P1R-110117			106063-P1P-111517		
Sample Date		10/20/2017			10/24/2017			11/1/2017			11/15/2017		
Sample Purpose		REG			REG			REG			REG		
Chemical Class and Analytical Method ^a	Parameter	Result	Val Qual	LOQ	Result	Val Qual	LOQ	Result	Val Qual	LOQ	Result	Val Qual	LOQ
General Chemistry (mg/L) SM2320b, EPA Method 300, EPA Method 353.2, SM4500 PE ^c	ALKALINITY	NS	--	--	213		1	NS	--	--	154		1
	BROMIDE	NS	--	--	0.149	J-	0.125	NS	--	--	0.136	J	0.125
	CHLORIDE	NS	--	--	12.9		0.33	NS	--	--	12.4		0.33
	IODIDE	NS	--	--	ND	U	0.75	NS	--	--	ND	U	0.75
	NITRATE	NS	--	--	NA	--	--	NS	--	--	NA	--	--
	NITRITE	NS	--	--	NA	--	--	NS	--	--	NA	--	--
	NITROGEN, NITRATE-NITRITE	NS	--	--	ND	U	0.375	NS	--	--	ND	U	0.375
	O-PHOSPHATE (AS P)	NS	--	--	ND	U	0.02	NS	--	--	0.0281	J	0.02
	ORTHOPHOSPHATE	NS	--	--	NA	--	--	NS	--	--	NA	--	--
PHOSPHORUS	NS	--	--	NA	--	--	NS	--	--	NA	--	--	
SULFATE	NS	--	--	26		1	NS	--	--	27.7		1	
Metals (mg/L) EPA Method 6010	LEAD	NS	--	--	NS	--	--	NS	--	--	NS	--	--
Dissolved Metals (mg/L) EPA Method 6010	IRON	NS	--	--	ND	U	0.06	NS	--	--	ND	U	0.06
	MANGANESE	NS	--	--	0.0331		0.006	NS	--	--	0.0393		0.006
δ2H (‰) Mass Spectrometry, USGS Reston, VA	DELTA2H	-95.37		-99	-97.16		-99	-94.1		-99	-95.56		-99
VOCs (µg/L) EPA Method 8260	1,1,2-TRICHLOROETHANE	NS	--	--	ND	U	1	NS	--	--	ND	U	1
	1,2,4-TRICHLOROBENZENE	NS	--	--	NS	--	--	NS	--	--	NA	--	--
	1,2,4-TRIMETHYLBENZENE	NS	--	--	ND	U	1	NS	--	--	ND	U	1
	1,2-DIBROMOETHANE	NS	--	--	ND	U	1	NS	--	--	ND	U	1
	1,2-DICHLOROETHANE	NS	--	--	0.881	J	1	NS	--	--	ND	U	1
	1,3,5-TRIMETHYLBENZENE	NS	--	--	ND	U	1	NS	--	--	ND	U	1
	2-BUTANONE	NS	--	--	ND	U	10	NS	--	--	ND	U	10
	2-CHLOROTOLUENE	NS	--	--	ND	U	1	NS	--	--	ND	U	1
	2-HEXANONE	NS	--	--	ND	U	5	NS	--	--	ND	U	5
	4-METHYL-2-PENTANONE	NS	--	--	ND	U	5	NS	--	--	ND	U	5
	ACETONE	NS	--	--	ND	U	10	NS	--	--	8.05	J	10
	BENZENE	NS	--	--	ND	U	1	NS	--	--	ND	U	1
	CARBON DISULFIDE	NS	--	--	ND	U	1	NS	--	--	ND	U	1
	CHLOROMETHANE	NS	--	--	ND	U	1	NS	--	--	ND	U	1
	CIS-1,2-DICHLOROETHENE	NS	--	--	NS	--	--	NS	--	--	NA	--	--
	DICHLORODIFLUOROMETHANE	NS	--	--	ND	U	2	NS	--	--	ND	U	2
	ETHYLBENZENE	NS	--	--	ND	U	1	NS	--	--	ND	U	1
	ISOPROPYLBENZENE	NS	--	--	ND	U	1	NS	--	--	ND	U	1
	M,P-XYLENES	NS	--	--	NS	--	--	NS	--	--	NA	--	--
	METHYL TERT-BUTYL ETHER	NS	--	--	ND	U	1	NS	--	--	ND	U	1
	METHYLENE CHLORIDE	NS	--	--	ND	U	2	NS	--	--	ND	U	2
	NAPHTHALENE	NS	--	--	ND	U	1	NS	--	--	ND	U	1
	N-BUTYLBENZENE	NS	--	--	ND	U	1	NS	--	--	ND	U	1
	N-PROPYLBENZENE	NS	--	--	ND	U	1	NS	--	--	ND	U	1
	O-XYLENE	NS	--	--	NS	--	--	NS	--	--	NA	--	--
	P-ISOPROPYLTOLUENE	NS	--	--	ND	U	1	NS	--	--	ND	U	1
	SEC-BUTYLBENZENE	NS	--	--	ND	U	1	NS	--	--	ND	U	1
	TERT-BUTYLBENZENE	NS	--	--	ND	U	1	NS	--	--	ND	U	1
	TETRACHLOROETHENE	NS	--	--	NS	--	--	NS	--	--	NA	--	--
	TOLUENE	NS	--	--	ND	U	1	NS	--	--	ND	U	1
	TRANS-1,2-DICHLOROETHENE	NS	--	--	NS	--	--	NS	--	--	NA	--	--
	TRICHLOROETHENE	NS	--	--	ND	U	1	NS	--	--	ND	U	1
	TRICHLOROFUOROMETHANE	NS	--	--	ND	U	2	NS	--	--	ND	U	2
VINYL CHLORIDE	NS	--	--	NS	--	--	NS	--	--	NA	--	--	
XYLENES	NS	--	--	ND	U	3	NS	--	--	ND	U	3	

Refer to notes at the end of the table.

**Table 7
Analytical Data Table for KAFB-106063**

Phase Designation		Phase 1 Passive			Phase 2 Recirculation								
Sample ID		106063-P1P-112817			106063-P2R-011018			106063-P2R-011818			106063-P2R-012518		
Sample Date		11/28/2017			1/10/2018			1/18/2018			1/25/2018		
Sample Purpose		REG			REG			REG			REG		
Chemical Class and Analytical Method ^a	Parameter	Result	Val Qual	LOQ	Result	Val Qual	LOQ	Result	Val Qual	LOQ	Result	Val Qual	LOQ
Microbial Community (cells/mL) QuantArray-Chlor	1,1 DCA Reductase (DCA)	ND	U	4.9	NS	--	--	NS	--	--	ND	U	8.9
	1,2 DCA Reductase (DCAR)	ND	U	4.9	NS	--	--	NS	--	--	ND	U	8.9
	BAV1 Vinyl Chloride Reductase (BVC)	ND	U	0.5	NS	--	--	NS	--	--	ND	U	0.9
	cer A Reductase	NA	--	--	NS	--	--	NS	--	--	ND	U	8.9
	Chloroform Reductase (CFR)	ND	U	4.9	NS	--	--	NS	--	--	ND	U	8.9
	Dehalobacter DCM (DCM)	ND	U	4.9	NS	--	--	NS	--	--	ND	U	8.9
	Dehalobacter spp. (DHBt)	ND	U	4.9	NS	--	--	NS	--	--	123000		8.9
	Dehalobium chlorocoercia (DECO)	245		4.9	NS	--	--	NS	--	--	20600		8.9
	Dehalococcoides (DHC)	ND	U	0.5	NS	--	--	NS	--	--	ND	U	0.9
	Dehalogenimonas spp. (DHG)	ND	U	4.9	NS	--	--	NS	--	--	ND	U	8.9
	Desulfitobacterium spp. (DSB)	ND	U	4.9	NS	--	--	NS	--	--	48700		8.9
	Desulfuromonas spp. (DSM)	ND	U	4.9	NS	--	--	NS	--	--	126		8.9
	Dichloromethane Dehalogenase (DCMA)	ND	U	4.9	NS	--	--	NS	--	--	ND	U	8.9
	Epoxyalkane Transferase (EtnE)	1970		4.9	NS	--	--	NS	--	--	106		8.9
	Ethene Monooxygenase (EtnC)	230		4.9	NS	--	--	NS	--	--	ND	U	8.9
	Methanogens (MGN)	8730		4.9	NS	--	--	NS	--	--	16.9		8.9
	PCE Reductase (PCE-1)	NA	--	--	NS	--	--	NS	--	--	ND	U	8.9
	Phenol Hydroxylase (PHE)	53000		4.9	NS	--	--	NS	--	--	20100		8.9
	PMMO	30.2		4.9	NS	--	--	NS	--	--	NA	--	--
	Soluble Methane Monooxygenase (SMMO)	788		4.9	NS	--	--	NS	--	--	ND	U	8.9
	Sulfate Reducing Bacteria (APS)	27200		4.9	NS	--	--	NS	--	--	124000		8.9
	tceA Reductase (TCE)	ND	U	0.5	NS	--	--	NS	--	--	ND	U	0.9
	Toluene Dioxygenase (TOD)	ND	U	4.9	NS	--	--	NS	--	--	ND	U	8.9
	Toluene Monooxygenase (RMO)	6230		4.9	NS	--	--	NS	--	--	9740		8.9
	Toluene Monooxygenase 2 (RDEG)	115000		4.9	NS	--	--	NS	--	--	14400		8.9
Total Eubacteria (EBAC)	698000		4.9	NS	--	--	NS	--	--	11600000		8.9	
trans-1,2-DCE Reductase (TDR)	ND	U	4.9	NS	--	--	NS	--	--	ND	U	8.9	
Trichlorobenzene Dioxygenase (TCBO)	ND	U	4.9	NS	--	--	NS	--	--	ND	U	8.9	
Vinyl Chloride Reductase (VCR)	ND	U	0.5	NS	--	--	NS	--	--	ND	U	0.9	
EDB (µg/L) EPA Method 8011	1,2-DIBROMOETHANE	ND	U	0.0191	0.981		0.0948	2.92		0.188	2.47	J+	0.194
VFAs (mg/L) EPA Method 300m	ACETIC ACID	0.64	J	1	ND	U	1	ND	U	1	0.45	J	1
	BUTYRIC ACID	ND	U	1	ND	U	1	ND	U	1	ND	U	1
	FORMIC ACID	ND	U	1	ND	U	1	ND	U	1	ND	U	1
	LACTIC ACID	ND	U	1	0.94	J	1	1.07		1	1.68		1
	PROPIONIC ACID	ND	U	1	ND	U	1	ND	U	1	ND	U	1
	PYRUVIC ACID	ND	U	1	ND	U	1	ND	U	1	ND	U	1
	VALERIC ACID	ND	U	1	ND	U	1	ND	U	1	ND	U	1
Fluorometric (µg/L) Spectrofluorophotometry	FLUORESCEIN	ND	U	0.01	NS	--	--	NS	--	--	NS	--	--
Reduced Gases (µg/L) RSKSOP-175	ACETYLENE	ND	U	10	ND	U	10	ND	U	10	ND	U	10
	ETHANE	ND	U	4	ND	U	4	ND	U	4	ND	U	4
	ETHYLENE	ND	U	5	ND	U	5	ND	U	5	1.83	J	5
	METHANE	ND	U	2	1.71	J	2	46.6		2	39.4	J+	2
	PROPANE	ND	U	6	ND	U	6	ND	U	6	ND	U	6

Table 7
Analytical Data Table for KAFB-106063

Phase Designation		Phase 1 Passive			Phase 2 Recirculation								
Sample ID		106063-P1P-112817			106063-P2R-011018			106063-P2R-011818			106063-P2R-012518		
Sample Date		11/28/2017			1/10/2018			1/18/2018			1/25/2018		
Sample Purpose		REG			REG			REG			REG		
Chemical Class and Analytical Method ^a	Parameter	Result	Val Qual	LOQ	Result	Val Qual	LOQ	Result	Val Qual	LOQ	Result	Val Qual	LOQ
General Chemistry (mg/L) SM2320b, EPA Method 300, EPA Method 353.2, SM4500 PE ^c	ALKALINITY	178		1	284		1	358		1	327		1
	BROMIDE	0.177	J	0.125	0.634		0.125	0.623		0.25	0.538		0.125
	CHLORIDE	12.2		0.33	42.6		0.33	54.2		0.66	39.7		0.33
	IODIDE	ND	U	0.75	ND	U	0.75	ND	U	0.75	ND	U	0.75
	NITRATE	NA	--	--	NA	--	--	NA	--	--	NA	--	--
	NITRITE	NA	--	--	NA	--	--	NA	--	--	NA	--	--
	NITROGEN, NITRATE-NITRITE	ND	U	0.375	ND	U	0.375	ND	U	0.375	ND	U	0.375
	O-PHOSPHATE (AS P)	0.0116	J	0.02	0.0172	J	0.02	0.0154	J	0.02	ND	U	0.02
	ORTHOPHOSPHATE	NA	--	--	NA	--	--	NA	--	--	NA	--	--
PHOSPHORUS	NA	--	--	NA	--	--	NA	--	--	NA	--	--	
SULFATE	24.8		1	17.2	J+	1	0.873	J+	2	5.29		1	
Metals (mg/L) EPA Method 6010	LEAD	NS	--	--	NS	--	--	NS	--	--	NS	--	--
Dissolved Metals (mg/L) EPA Method 6010	IRON	ND	U	0.06	0.129		0.06	1.68		0.06	0.254	J-	0.06
	MANGANESE	0.0782		0.006	0.234		0.006	3.56		0.006	0.574	J-	0.006
δ2H (‰) Mass Spectrometry, USGS Reston, VA	DELTA2H	-95.76		-99	NS	--	--	NS	--	--	NS	--	--
VOCs (µg/L) EPA Method 8260	1,1,2-TRICHLOROETHANE	ND	U	1	ND	U	25	ND	U	12.5	ND	U	25
	1,2,4-TRICHLOROBENZENE	NA	--	--	NA	--	--	NA	--	--	NA	--	--
	1,2,4-TRIMETHYLBENZENE	ND	U	1	157		25	154		12.5	256		25
	1,2-DIBROMOETHANE	ND	U	1	ND	U	25	ND	U	12.5	ND	U	25
	1,2-DICHLOROETHANE	0.605	J	1	ND	U	25	ND	U	12.5	ND	U	25
	1,3,5-TRIMETHYLBENZENE	ND	U	1	68.9		25	76.8		12.5	120		25
	2-BUTANONE	ND	U	10	ND	U	250	ND	U	125	ND	U	250
	2-CHLOROTOLUENE	ND	U	1	ND	U	25	ND	U	12.5	ND	U	25
	2-HEXANONE	ND	U	5	ND	U	125	ND	U	62.5	ND	U	125
	4-METHYL-2-PENTANONE	ND	U	5	ND	U	125	46.2	J	62.5	ND	U	125
	ACETONE	7.26	J	10	ND	U	250	67.6	J	125	ND	U	250
	BENZENE	ND	U	1	2800		25	3160		12.5	3100		25
	CARBON DISULFIDE	ND	U	1	ND	U	25	ND	U	12.5	ND	U	25
	CHLOROMETHANE	ND	U	1	20.2		25	ND	U	12.5	ND	U	25
	CIS-1,2-DICHLOROETHENE	NA	--	--	NA	--	--	NA	--	--	NA	--	--
	DICHLORODIFLUOROMETHANE	ND	U	2	ND	U	50	ND	U	25	ND	U	50
	ETHYLBENZENE	ND	U	1	65.5		25	192		12.5	541		25
	ISOPROPYLBENZENE	ND	U	1	43	J	25	57		12.5	82.3		25
	M,P-XYLENES	NA	--	--	NA	--	--	NA	--	--	NA	--	--
	METHYL TERT-BUTYL ETHER	ND	U	1	ND	U	25	ND	U	12.5	ND	U	25
	METHYLENE CHLORIDE	ND	U	2	ND	U	50	ND	U	25	ND	U	50
	NAPHTHALENE	ND	U	1	45		25	72.7		12.5	83.7		25
	N-BUTYLBENZENE	ND	U	1	ND	U	25	8.31	J	12.5	ND	U	25
	N-PROPYLBENZENE	ND	U	1	31.1	J	25	53.7		12.5	89.9		25
	O-XYLENE	NA	--	--	NA	--	--	NA	--	--	NA	--	--
	P-ISOPROPYLTOLUENE	ND	U	1	ND	U	25	12.5	J	12.5	ND	U	25
	SEC-BUTYLBENZENE	ND	U	1	ND	U	25	10.9	J	12.5	15.9	J	25
	TERT-BUTYLBENZENE	ND	U	1	ND	U	25	ND	U	12.5	ND	U	25
	TETRACHLOROETHENE	NA	--	--	NA	--	--	NA	--	--	NA	--	--
	TOLUENE	ND	U	1	43.8	J	25	282		12.5	1050		25
	TRANS-1,2-DICHLOROETHENE	NA	--	--	NA	--	--	NA	--	--	NA	--	--
	TRICHLOROETHENE	ND	U	1	ND	U	25	ND	U	12.5	ND	U	25
	TRICHLOROFUOROMETHANE	ND	U	2	ND	U	50	ND	U	25	ND	U	50
VINYL CHLORIDE	NA	--	--	NA	--	--	NA	--	--	NA	--	--	
XYLENES	ND	U	3	715		75	935		37.5	1380		75	

Refer to notes at the end of the table.

Table 7
Analytical Data Table for KAFB-106063

Phase Designation		Phase 2 Passive											
Sample ID		106063-P2P-030618			106063-P2P-041018			106063-P2P-050818			106063-P2P-061218		
Sample Date		3/6/2018			4/10/2018			5/8/2018			6/12/2018		
Sample Purpose		REG			REG			REG			REG		
Chemical Class and Analytical Method ^a	Parameter	Result	Val Qual	LOQ	Result	Val Qual	LOQ	Result	Val Qual	LOQ	Result	Val Qual	LOQ
Microbial Community (cells/mL) QuantArray-Chlor	1,1 DCA Reductase (DCA)	NS	--	--	NS	--	--	ND	U	5	NS	--	--
	1,2 DCA Reductase (DCAR)	NS	--	--	NS	--	--	ND	U	5	NS	--	--
	BAV1 Vinyl Chloride Reductase (BVC)	NS	--	--	NS	--	--	ND	U	0.5	NS	--	--
	cer A Reductase	NS	--	--	NS	--	--	ND	U	5	NS	--	--
	Chloroform Reductase (CFR)	NS	--	--	NS	--	--	ND	U	5	NS	--	--
	Dehalobacter DCM (DCM)	NS	--	--	NS	--	--	ND	U	5	NS	--	--
	Dehalobacter spp. (DHBt)	NS	--	--	NS	--	--	147000		5	NS	--	--
	Dehalobium chlorocoercia (DECO)	NS	--	--	NS	--	--	5210		5	NS	--	--
	Dehalococcoides (DHC)	NS	--	--	NS	--	--	ND	U	0.5	NS	--	--
	Dehalogenimonas spp. (DHG)	NS	--	--	NS	--	--	ND	U	5	NS	--	--
	Desulfitobacterium spp. (DSB)	NS	--	--	NS	--	--	78100		5	NS	--	--
	Desulfuromonas spp. (DSM)	NS	--	--	NS	--	--	141		5	NS	--	--
	Dichloromethane Dehalogenase (DCMA)	NS	--	--	NS	--	--	ND	U	5	NS	--	--
	Epoxyalkane Transferase (EtnE)	NS	--	--	NS	--	--	235		5	NS	--	--
	Ethene Monooxygenase (EtnC)	NS	--	--	NS	--	--	ND	U	5	NS	--	--
	Methanogens (MGN)	NS	--	--	NS	--	--	162		5	NS	--	--
	PCE Reductase (PCE-1)	NS	--	--	NS	--	--	ND	U	5	NS	--	--
	Phenol Hydroxylase (PHE)	NS	--	--	NS	--	--	4390		5	NS	--	--
	PMMO	NS	--	--	NS	--	--	NA	--	--	NS	--	--
	Soluble Methane Monooxygenase (SMMO)	NS	--	--	NS	--	--	333		5	NS	--	--
	Sulfate Reducing Bacteria (APS)	NS	--	--	NS	--	--	47500		5	NS	--	--
	tceA Reductase (TCE)	NS	--	--	NS	--	--	ND	U	0.5	NS	--	--
	Toluene Dioxygenase (TOD)	NS	--	--	NS	--	--	ND	U	5	NS	--	--
	Toluene Monooxygenase (RMO)	NS	--	--	NS	--	--	3460		5	NS	--	--
	Toluene Monooxygenase 2 (RDEG)	NS	--	--	NS	--	--	2120		5	NS	--	--
Total Eubacteria (EBAC)	NS	--	--	NS	--	--	3160000		5	NS	--	--	
trans-1,2-DCE Reductase (TDR)	NS	--	--	NS	--	--	ND	U	5	NS	--	--	
Trichlorobenzene Dioxygenase (TCBO)	NS	--	--	NS	--	--	ND	U	5	NS	--	--	
Vinyl Chloride Reductase (VCR)	NS	--	--	NS	--	--	ND	U	0.5	NS	--	--	
EDB (µg/L) EPA Method 8011	1,2-DIBROMOETHANE	4.4	J+	1.91	3.78	J	1.89	3.54		0.189	1.81		0.0949
VFAs (mg/L) EPA Method 300m	ACETIC ACID	1.3		1	2.1		1	0.8	J	1	0.9	J	1
	BUTYRIC ACID	ND	U	1	ND	U	1	ND	U	1	ND	U	1
	FORMIC ACID	ND	U	1	ND	U	1	ND	U	1	ND	U	1
	LACTIC ACID	0.98	J	1	0.8	J	1	0.7	J	1	0.6	J	1
	PROPIONIC ACID	1		1	1		1	ND	U	1	ND	U	1
	PYRUVIC ACID	ND	U	1	ND	U	1	ND	U	1	ND	U	1
	VALERIC ACID	ND	U	1	ND	U	1	ND	U	1	ND	U	1
Fluorometric (µg/L) Spectrofluorophotometry	FLUORESCEIN	NS	--	--	NS	--	--	NS	--	--	NS	--	--
Reduced Gases (µg/L) RSKSOP-175	ACETYLENE	ND	U	10	ND	U	10	ND	U	10	ND	U	10
	ETHANE	ND	U	4	ND	U	4	ND	U	4	ND	U	4
	ETHYLENE	3.04	J	5	4.12		5	6.2		5	7.7		5
	METHANE	49.6		2	64.79		2	48.11		2	9.6		2
	PROPANE	ND	U	6	ND	U	6	ND	U	6	ND	U	6

Table 7
Analytical Data Table for KAFB-106063

Phase Designation		Phase 2 Passive												
Sample ID		106063-P2P-030618			106063-P2P-041018			106063-P2P-050818			106063-P2P-061218			
Sample Date		3/6/2018			4/10/2018			5/8/2018			6/12/2018			
Sample Purpose		REG			REG			REG			REG			
Chemical Class and Analytical Method ^a	Parameter	Result	Val Qual	LOQ	Result	Val Qual	LOQ	Result	Val Qual	LOQ	Result	Val Qual	LOQ	
General Chemistry (mg/L) SM2320b, EPA Method 300, EPA Method 353.2, SM4500 PE ^c	ALKALINITY	352		1	296		1	372		1	400		1	
	BROMIDE	0.512		0.25	0.499	J-	0.25	0.566		0.25	0.585		0.25	
	CHLORIDE	42.4		0.66	44.2		0.66	49.1		0.66	52		0.66	
	IODIDE	ND	U	0.75	ND	U	0.75	ND	U	0.75	ND	U	0.75	
	NITRATE	NA	--	--	ND	U	0.2	ND	U	0.2	ND	U	0.2	
	NITRITE	NA	--	--	ND	U	0.2	ND	U	0.2	ND	U	0.2	
	NITROGEN, NITRATE-NITRITE	ND	U	0.375	NA	--	--	NA	--	--	NA	--	--	
	O-PHOSPHATE (AS P)	ND	U	0.02	ND	U	0.02	ND	U	0.02	0.0238			0.02
	ORTHOPHOSPHATE	NA	--	--	NA	--	--	NA	--	--	NA	--	--	
	PHOSPHORUS	NA	--	--	NA	--	--	NA	--	--	NA	--	--	
SULFATE	ND	U	2	ND	U	2	ND	U	2	ND	U	2		
Metals (mg/L) EPA Method 6010	LEAD	NS	--	--	NS	--	--	NS	--	--	NS	--	--	
Dissolved Metals (mg/L) EPA Method 6010	IRON	1.54		0.06	2.18	J-	0.06	4.92		0.06	8.3		0.06	
	MANGANESE	1.71		0.006	2.22	J+	0.006	3.19		0.006	4.23		0.006	
δ2H (‰) Mass Spectrometry, USGS Reston, VA	DELTA2H	NS	--	--	NS	--	--	NS	--	--	NS	--	--	
VOCs (µg/L) EPA Method 8260	1,1,2-TRICHLOROETHANE	ND	U	25	ND	U	25	ND	U	50	ND	U	25	
	1,2,4-TRICHLOROBENZENE	NA	--	--	NA	--	--	NA	--	--	NA	--	--	
	1,2,4-TRIMETHYLBENZENE	ND	U	25	190		25	257		50	264		25	
	1,2-DIBROMOETHANE	ND	U	25	ND	U	25	ND	U	50	ND	U	25	
	1,2-DICHLOROETHANE	ND	U	25	ND	U	25	ND	U	50	ND	U	25	
	1,3,5-TRIMETHYLBENZENE	95.9		25	96.2		25	118		50	131		25	
	2-BUTANONE	ND	U	250	ND	U	250	ND	U	500	ND	U	250	
	2-CHLOROTOLUENE	ND	U	25	ND	U	25	ND	U	50	ND	U	25	
	2-HEXANONE	ND	U	125	ND	U	125	ND	U	250	ND	U	125	
	4-METHYL-2-PENTANONE	ND	U	125	ND	U	125	ND	U	250	69.6	J	125	
	ACETONE	ND	U	250	ND	U	250	ND	U	500	ND	U	250	
	BENZENE	2460		25	2050		25	2120		50	2940		25	
	CARBON DISULFIDE	ND	U	25	ND	U	25	ND	U	50	ND	U	25	
	CHLOROMETHANE	ND	U	25	ND	U	25	ND	U	50	ND	U	25	
	CIS-1,2-DICHLOROETHENE	NA	--	--	NA	--	--	NA	--	--	NA	--	--	
	DICHLORODIFLUOROMETHANE	ND	U	50	ND	U	50	ND	U	100	ND	U	50	
	ETHYLBENZENE	866		25	784		25	1080		50	1500		25	
	ISOPROPYLBENZENE	91.9		25	106		25	135		50	169		25	
	M,P-XYLENES	NA	--	--	NA	--	--	NA	--	--	NA	--	--	
	METHYL TERT-BUTYL ETHER	ND	U	25	ND	U	25	ND	U	50	ND	U	25	
	METHYLENE CHLORIDE	ND	U	50	ND	U	50	ND	U	100	ND	U	50	
	NAPHTHALENE	69.6		25	80.4		25	126		50	127		25	
	N-BUTYLBENZENE	ND	U	25	ND	U	25	ND	U	50	17	J	25	
	N-PROPYLBENZENE	85.8		25	75.7		25	103		50	132		25	
	O-XYLENE	NA	--	--	NA	--	--	NA	--	--	NA	--	--	
	P-ISOPROPYLTOLUENE	102		25	105		25	142		50	140		25	
	SEC-BUTYLBENZENE	14.8	J	25	13.1	J	25	ND	U	50	23.5	J	25	
	TERT-BUTYLBENZENE	ND	U	25	ND	U	25	ND	U	50	ND	U	25	
	TETRACHLOROETHENE	NA	--	--	NA	--	--	NA	--	--	NA	--	--	
	TOLUENE	4080		25	3770		25	6680		50	6320		25	
	TRANS-1,2-DICHLOROETHENE	NA	--	--	NA	--	--	NA	--	--	NA	--	--	
	TRICHLOROETHENE	ND	U	25	ND	U	25	ND	U	50	ND	U	25	
	TRICHLOROFUOROMETHANE	ND	U	50	ND	U	50	ND	U	100	ND	U	50	
	VINYL CHLORIDE	NA	--	--	NA	--	--	NA	--	--	NA	--	--	
XYLENES	1580		75	1290		75	1760		150	1850		75		

Refer to notes at the end of the table.

Table 7
Analytical Data Table for KAFB-106063

Phase Designation		Phase 3 Recirculation						Phase 3 Recirculation					
Sample ID		106063-P3R-080818			106063-P3R-081618			106063-P3R-082218			106063-P3R-082918		
Sample Date		8/8/2018			8/16/2018			8/22/2018			8/29/2018		
Sample Purpose		REG			REG			REG			REG		
Chemical Class and Analytical Method ^a	Parameter	Result	Val Qual	LOQ	Result	Val Qual	LOQ	Result	Val Qual	LOQ	Result	Val Qual	LOQ
Microbial Community (cells/mL) QuantArray-Chlor	1,1 DCA Reductase (DCA)	NS	--	--	NS	--	--	ND	U	4.8	NS	--	--
	1,2 DCA Reductase (DCAR)	NS	--	--	NS	--	--	ND	U	4.8	NS	--	--
	BAV1 Vinyl Chloride Reductase (BVC)	NS	--	--	NS	--	--	ND	U	0.5	NS	--	--
	cer A Reductase	NS	--	--	NS	--	--	ND	U	4.8	NS	--	--
	Chloroform Reductase (CFR)	NS	--	--	NS	--	--	ND	U	4.8	NS	--	--
	Dehalobacter DCM (DCM)	NS	--	--	NS	--	--	ND	U	4.8	NS	--	--
	Dehalobacter spp. (DHBt)	NS	--	--	NS	--	--	149000		4.8	NS	--	--
	Dehalobium chlorocoercia (DECO)	NS	--	--	NS	--	--	5180		4.8	NS	--	--
	Dehalococcoides (DHC)	NS	--	--	NS	--	--	2.2		0.5	NS	--	--
	Dehalogenimonas spp. (DHG)	NS	--	--	NS	--	--	ND	U	4.8	NS	--	--
	Desulfitobacterium spp. (DSB)	NS	--	--	NS	--	--	66100		4.8	NS	--	--
	Desulfuromonas spp. (DSM)	NS	--	--	NS	--	--	ND	U	4.8	NS	--	--
	Dichloromethane Dehalogenase (DCMA)	NS	--	--	NS	--	--	ND	U	4.8	NS	--	--
	Epoxyalkane Transferase (EtnE)	NS	--	--	NS	--	--	49.8		4.8	NS	--	--
	Ethene Monooxygenase (EtnC)	NS	--	--	NS	--	--	ND	U	4.8	NS	--	--
	Methanogens (MGN)	NS	--	--	NS	--	--	26.3		4.8	NS	--	--
	PCE Reductase (PCE-1)	NS	--	--	NS	--	--	ND	U	4.8	NS	--	--
	Phenol Hydroxylase (PHE)	NS	--	--	NS	--	--	374		4.8	NS	--	--
	PMMO	NS	--	--	NS	--	--	NA	--	--	NS	--	--
	Soluble Methane Monooxygenase (SMMO)	NS	--	--	NS	--	--	1490		4.8	NS	--	--
	Sulfate Reducing Bacteria (APS)	NS	--	--	NS	--	--	143000		4.8	NS	--	--
	tceA Reductase (TCE)	NS	--	--	NS	--	--	ND	U	0.5	NS	--	--
	Toluene Dioxygenase (TOD)	NS	--	--	NS	--	--	ND	U	4.8	NS	--	--
	Toluene Monooxygenase (RMO)	NS	--	--	NS	--	--	1670		4.8	NS	--	--
	Toluene Monooxygenase 2 (RDEG)	NS	--	--	NS	--	--	634		4.8	NS	--	--
	Total Eubacteria (EBAC)	NS	--	--	NS	--	--	5580000		4.8	NS	--	--
trans-1,2-DCE Reductase (TDR)	NS	--	--	NS	--	--	ND	U	4.8	NS	--	--	
Trichlorobenzene Dioxygenase (TCBO)	NS	--	--	NS	--	--	ND	U	4.8	NS	--	--	
Vinyl Chloride Reductase (VCR)	NS	--	--	NS	--	--	ND	U	0.5	NS	--	--	
EDB (µg/L) EPA Method 8011	1,2-DIBROMOETHANE	3.1		0.031	3.9		0.03	4.7		0.03	6.4		0.03
VFAs (mg/L) EPA Method 300m	ACETIC ACID	0.6	J	1	0.9	J	1	2.1		1	4.8		1
	BUTYRIC ACID	ND	U	1	ND	U	1	ND	U	1	ND	U	1
	FORMIC ACID	ND	U	1	ND	U	1	ND	U	1	ND	U	1
	LACTIC ACID	0.8	J	1	0.9	J	1	0.8	J	1	0.8	J	1
	PROPIONIC ACID	ND	U	1	ND	U	1	ND	U	1	ND	U	1
	PYRUVIC ACID	ND	U	1	ND	U	1	ND	U	1	ND	U	1
	VALERIC ACID	ND	U	1	ND	U	1	ND	U	1	ND	U	1
Fluorometric (µg/L) Spectrofluorophotometry	FLUORESCCEIN	NS	--	--	NS	--	--	NS	--	--	NS	--	--
Reduced Gases (µg/L) RSKSOP-175	ACETYLENE	NS	--	--	ND	U	10	ND	U	10	ND	U	10
	ETHANE	NS	--	--	ND	U	4	ND	U	4	ND	U	4
	ETHYLENE	NS	--	--	8.2		5	9.6		5	6.4		5
	METHANE	NS	--	--	3.9		2	23.7		2	15.5		2
	PROPANE	NS	--	--	ND	U	6	ND	U	6	ND	U	6

**Table 7
Analytical Data Table for KAFB-106063**

Phase Designation		Phase 3 Recirculation						Phase 3 Recirculation					
Sample ID		106063-P3R-080818			106063-P3R-081618			106063-P3R-082218			106063-P3R-082918		
Sample Date		8/8/2018			8/16/2018			8/22/2018			8/29/2018		
Sample Purpose		REG			REG			REG			REG		
Chemical Class and Analytical Method ^a	Parameter	Result	Val Qual	LOQ	Result	Val Qual	LOQ	Result	Val Qual	LOQ	Result	Val Qual	LOQ
General Chemistry (mg/L) SM2320b, EPA Method 300, EPA Method 353.2, SM4500 PE ^c	ALKALINITY	370		5	380		5	380		5	400		5
	BROMIDE	1.3		1	0.99		0.5	1.1		0.5	0.98		0.5
	CHLORIDE	42		1	49		0.5	49		0.5	52		0.5
	IODIDE	ND	U	0.75	1.3		0.75	4.4		0.75	5.3		0.75
	NITRATE	NA	--	--	NA	--	--	NA	--	--	NA	--	--
	NITRITE	NA	--	--	NA	--	--	NA	--	--	NA	--	--
	NITROGEN, NITRATE-NITRITE	ND	R	0.05	ND	U	0.05	ND		0.05	ND	U	0.05
	O-PHOSPHATE (AS P)	NA	--	--	NA	--	--	NA	--	--	NA	--	--
	ORTHOPHOSPHATE	ND	R	0.15	ND	U	0.15	ND		0.15	ND	U	0.15
	PHOSPHORUS	NA	--	--	NA	--	--	NA	--	--	NA	--	--
SULFATE	4.1		2	ND	U	1	2.9		1	ND	U	1	
Metals (mg/L) EPA Method 6010	LEAD	NS	--	--	NS	--	--	NS	--	--	NS	--	--
Dissolved Metals (mg/L) EPA Method 6010	IRON	4.9		0.05	4.2		0.05	4.3		0.05	3.8		0.05
	MANGANESE	4.2		0.003	4.5		0.003	4.8		0.003	4.9		0.003
δ2H (‰) Mass Spectrometry, USGS Reston, VA	DELTA2H	NS	--	--	NS	--	--	NS	--	--	NS	--	--
VOCs (µg/L) EPA Method 8260	1,1,2-TRICHLOROETHANE	ND	U	0.5	ND	U	0.5	ND	U	10	ND	U	0.5
	1,2,4-TRICHLOROBENZENE	NA	--	--	NA	--	--	NA	--	--	NA	--	--
	1,2,4-TRIMETHYLBENZENE	210		20	270		100	290		20	310		50
	1,2-DIBROMOETHANE	5.3	J+	1	ND	U	1	ND	U	20	8.4	J+	1
	1,2-DICHLOROETHANE	3		1	2.7		1	ND	U	20	3		1
	1,3,5-TRIMETHYLBENZENE	120	J+	0.5	120		0.5	130		10	130	J+	0.5
	2-BUTANONE	3.9	J+	10	3.5	J	10	ND	U	200	6.2	J+	10
	2-CHLOROTOLUENE	ND	U	0.5	38		0.5	ND	U	10	ND	U	0.5
	2-HEXANONE	22	J+	5	22		5	ND	U	100	38	J+	5
	4-METHYL-2-PENTANONE	52	J+	5	52		5	68	J	100	63	J+	5
	ACETONE	24	J+	10	19		10	ND	U	200	34	J+	10
	BENZENE	2500		20	2300		100	2700		20	3000		50
	CARBON DISULFIDE	ND	U	2	ND	U	2	ND	U	40	ND	U	2
	CHLOROMETHANE	ND	U	1	ND	U	1	ND	U	20	ND	U	1
	CIS-1,2-DICHLOROETHENE	NA	--	--	NA	--	--	NA	--	--	NA	--	--
	DICHLORODIFLUOROMETHANE	ND	U	1	ND	U	1	ND	U	20	ND	U	1
	ETHYLBENZENE	1100		20	1300		100	1400		20	1500		50
	ISOPROPYLBENZENE	160	J+	1	140		1	160		20	160	J+	1
	M,P-XYLENES	NA	--	--	NA	--	--	NA	--	--	NA	--	--
	METHYL TERT-BUTYL ETHER	0.45	J+	0.5	0.48	J	0.5	ND	U	10	0.48	J+	0.5
	METHYLENE CHLORIDE	ND	U	5	ND	U	5	ND	U	100	ND	U	5
	NAPHTHALENE	100	J+	5	100		5	120		100	140	J+	5
	N-BUTYLBENZENE	16	J+	1	17		1	19	J	20	20	J+	1
	N-PROPYLBENZENE	100	J+	1	100		1	110		20	110	J+	1
	O-XYLENE	NA	--	--	NA	--	--	NA	--	--	NA	--	--
	P-ISOPROPYLTOLUENE	150	J+	1	150		1	130		20	160	J+	1
	SEC-BUTYLBENZENE	17	J+	1	17		1	19	J	20	18	J+	1
	TERT-BUTYLBENZENE	1.3	J+	1	ND	U	1	ND	U	20	1.5	J+	1
	TETRACHLOROETHENE	NA	--	--	NA	--	--	NA	--	--	NA	--	--
	TOLUENE	3200		20	2900		100	4100		50	6700		50
	TRANS-1,2-DICHLOROETHENE	NA	--	--	NA	--	--	NA	--	--	NA	--	--
	TRICHLOROETHENE	ND	U	1	ND	U	1	ND	U	20	ND	U	1
	TRICHLOROFUOROMETHANE	ND	U	1	ND	U	1	ND	U	20	ND	U	1
	VINYL CHLORIDE	NA	--	--	NA	--	--	NA	--	--	NA	--	--
XYLENES	1600		10	2100		50	2600		10	3100		25	

Refer to notes at the end of the table.

**Table 7
Analytical Data Table for KAFB-106063**

Phase Designation		Phase 3 Recirculation			Phase 3 Passive								
Sample ID		106063-P3R-082918-FD			106063-P3P-091218			106063-P3P-100418			106063-P3P-111518		
Sample Date		8/29/2018			9/12/2018			10/4/2018			11/15/2018		
Sample Purpose		FD			REG			REG			REG		
Chemical Class and Analytical Method ^a	Parameter	Result	Val Qual	LOQ	Result	Val Qual	LOQ	Result	Val Qual	LOQ	Result	Val Qual	LOQ
Microbial Community (cells/mL) QuantArray-Chlor	1,1 DCA Reductase (DCA)	NS	--	--	NS	--	--	NS	--	--	ND	U	5.1
	1,2 DCA Reductase (DCAR)	NS	--	--	NS	--	--	NS	--	--	ND	U	5.1
	BAV1 Vinyl Chloride Reductase (BVC)	NS	--	--	NS	--	--	NS	--	--	0.3	J	0.5
	cer A Reductase	NS	--	--	NS	--	--	NS	--	--	ND	U	5.1
	Chloroform Reductase (CFR)	NS	--	--	NS	--	--	NS	--	--	ND	U	5.1
	Dehalobacter DCM (DCM)	NS	--	--	NS	--	--	NS	--	--	ND	U	5.1
	Dehalobacter spp. (DHBt)	NS	--	--	NS	--	--	NS	--	--	44900		5.1
	Dehalobium chlorocoercia (DECO)	NS	--	--	NS	--	--	NS	--	--	1430		5.1
	Dehalococcoides (DHC)	NS	--	--	NS	--	--	NS	--	--	13.9		0.5
	Dehalogenimonas spp. (DHG)	NS	--	--	NS	--	--	NS	--	--	ND	U	5.1
	Desulfitobacterium spp. (DSB)	NS	--	--	NS	--	--	NS	--	--	38200		5.1
	Desulfuromonas spp. (DSM)	NS	--	--	NS	--	--	NS	--	--	28.8		5.1
	Dichloromethane Dehalogenase (DCMA)	NS	--	--	NS	--	--	NS	--	--	ND	U	5.1
	Epoxyalkane Transferase (EtnE)	NS	--	--	NS	--	--	NS	--	--	ND	U	5.1
	Ethene Monooxygenase (EtnC)	NS	--	--	NS	--	--	NS	--	--	ND	U	5.1
	Methanogens (MGN)	NS	--	--	NS	--	--	NS	--	--	273		5.1
	PCE Reductase (PCE-1)	NS	--	--	NS	--	--	NS	--	--	0.5	J	5.1
	Phenol Hydroxylase (PHE)	NS	--	--	NS	--	--	NS	--	--	2200		5.1
	PMMO	NS	--	--	NS	--	--	NS	--	--	NA	--	--
	Soluble Methane Monooxygenase (SMMO)	NS	--	--	NS	--	--	NS	--	--	642		5.1
	Sulfate Reducing Bacteria (APS)	NS	--	--	NS	--	--	NS	--	--	80200		5.1
	tceA Reductase (TCE)	NS	--	--	NS	--	--	NS	--	--	2.6		0.5
	Toluene Dioxygenase (TOD)	NS	--	--	NS	--	--	NS	--	--	ND	U	5.1
	Toluene Monooxygenase (RMO)	NS	--	--	NS	--	--	NS	--	--	592		5.1
	Toluene Monooxygenase 2 (RDEG)	NS	--	--	NS	--	--	NS	--	--	694		5.1
Total Eubacteria (EBAC)	NS	--	--	NS	--	--	NS	--	--	1510000		5.1	
trans-1,2-DCE Reductase (TDR)	NS	--	--	NS	--	--	NS	--	--	ND	U	5.1	
Trichlorobenzene Dioxygenase (TCBO)	NS	--	--	NS	--	--	NS	--	--	ND	U	5.1	
Vinyl Chloride Reductase (VCR)	NS	--	--	NS	--	--	NS	--	--	7.3		0.5	
EDB (µg/L) EPA Method 8011	1,2-DIBROMOETHANE	6.1		0.029	6.1		0.029	3.4		0.015	1.8		0.0059
VFAs (mg/L) EPA Method 300m	ACETIC ACID	4.4		1	18.6		10	51.8		10	50.5		10
	BUTYRIC ACID	ND	U	1	ND	U	1	ND	U	1	ND	U	1
	FORMIC ACID	ND	U	1	ND	U	1	0.7	J	10	0.6	J	1
	LACTIC ACID	0.6	J	1	0.6	J	1	0.4	J	1	1	J	1
	PROPIONIC ACID	ND	U	1	ND	U	1	ND	U	1	ND	U	1
	PYRUVIC ACID	ND	U	1	ND	U	1	ND	U	1	ND	U	1
	VALERIC ACID	ND	U	1	ND	U	1	ND	U	1	ND	U	1
Fluorometric (µg/L) Spectrofluorophotometry	FLUORESCCEIN	NS	--	--	NS	--	--	NS	--	--	NS	--	--
Reduced Gases (µg/L) RSKSOP-175	ACETYLENE	ND	U	10	ND	U	10	ND	U	10	ND	U	10
	ETHANE	ND	U	4	ND	U	4	ND	U	4	ND	U	4
	ETHYLENE	8.7		5	11		5	17.5		5	17.5		5
	METHANE	21.7		2	39.6		2	102.3		2	244		2
	PROPANE	ND	U	6	ND	U	6	ND	U	6	0.9	J	6

Table 7
Analytical Data Table for KAFB-106063

Phase Designation		Phase 3 Recirculation			Phase 3 Passive								
Sample ID		106063-P3R-082918-FD			106063-P3P-091218			106063-P3P-100418			106063-P3P-111518		
Sample Date		8/29/2018			9/12/2018			10/4/2018			11/15/2018		
Sample Purpose		FD			REG			REG			REG		
Chemical Class and Analytical Method ^a	Parameter	Result	Val Qual	LOQ	Result	Val Qual	LOQ	Result	Val Qual	LOQ	Result	Val Qual	LOQ
General Chemistry (mg/L) SM2320b, EPA Method 300, EPA Method 353.2, SM4500 PE ^c	ALKALINITY	390		5	400		5	410		5	420		5
	BROMIDE	0.87		0.5	0.94		0.5	1.8		0.5	1.2		0.5
	CHLORIDE	52		0.5	52		0.5	49		0.5	48		0.5
	IODIDE	5		0.75	7.4		0.75	11		0.75	12		0.75
	NITRATE	NA	--	--	NA	--	--	NA	--	--	NA	--	--
	NITRITE	NA	--	--	NA	--	--	NA	--	--	NA	--	--
	NITROGEN, NITRATE-NITRITE	ND	U	0.05	ND	U	0.05	ND	U	0.05	ND	U	0.05
	O-PHOSPHATE (AS P)	NA	--	--	NA	--	--	NA	--	--	NA	--	--
	ORTHOPHOSPHATE	ND	U	0.15	ND	U	0.15	ND	U	0.15	ND	UJ	0.15
	PHOSPHORUS	NA	--	--	NA	--	--	NA	--	--	NA	--	--
SULFATE	ND	U	1	ND	U	1	ND	U	1	ND	U	1	
Metals (mg/L) EPA Method 6010	LEAD	NS	--	--	NS	--	--	NS	--	--	NS	--	--
Dissolved Metals (mg/L) EPA Method 6010	IRON	3.8		0.05	5		0.05	8		0.05	8.4		0.05
	MANGANESE	4.9		0.003	5.5		0.003	6.6		0.003	6.3		0.003
δ2H (‰) Mass Spectrometry, USGS Reston, VA	DELTA2H	NS	--	--	NS	--	--	NS	--	--	NS	--	--
VOCs (µg/L) EPA Method 8260	1,1,2-TRICHLOROETHANE	ND	U	50	ND	U	50	ND	U	25	ND	U	50
	1,2,4-TRICHLOROBENZENE	NA	--	--	NA	--	--	NA	--	--	NA	--	--
	1,2,4-TRIMETHYLBENZENE	330		100	410		100	600		50	510		100
	1,2-DIBROMOETHANE	ND	U	100	ND	U	100	ND	U	50	ND	U	100
	1,2-DICHLOROETHANE	ND	U	100	ND	U	100	ND	U	50	ND	U	100
	1,3,5-TRIMETHYLBENZENE	140		50	150		50	210		25	190		50
	2-BUTANONE	ND	U	1000	ND	U	1000	ND	U	500	ND	U	1000
	2-CHLOROTOLUENE	ND	U	50	ND	U	50	ND	U	25	ND	U	50
	2-HEXANONE	ND	U	500	ND	U	500	100	J	250	ND	U	500
	4-METHYL-2-PENTANONE	ND	U	500	ND	U	500	ND	U	250	ND	U	500
	ACETONE	ND	U	1000	ND	U	1000	ND	U	500	ND	U	1000
	BENZENE	3100		100	3500		100	6200		50	5200		100
	CARBON DISULFIDE	ND	U	200	ND	U	200	ND	U	100	ND	U	200
	CHLOROMETHANE	ND	U	100	ND	U	100	ND	U	50	ND	U	100
	CIS-1,2-DICHLOROETHENE	NA	--	--	NA	--	--	NA	--	--	NA	--	--
	DICHLORODIFLUOROMETHANE	ND	U	100	ND	U	100	ND	U	50	ND	U	100
	ETHYLBENZENE	1600		100	1600		100	2200		50	2100		100
	ISOPROPYLBENZENE	160		100	170		100	220		50	200		100
	M,P-XYLENES	NA	--	--	NA	--	--	NA	--	--	NA	--	--
	METHYL TERT-BUTYL ETHER	ND	U	50	ND	U	50	ND	U	25	ND	U	50
	METHYLENE CHLORIDE	270	J	500	ND	U	500	ND	U	250	ND	U	500
	NAPHTHALENE	ND	U	500	ND	U	500	200	J	250	ND	U	500
	N-BUTYLBENZENE	ND	U	100	ND	U	100	28	J	50	ND	U	100
	N-PROPYLBENZENE	120		100	120		100	150		50	140		100
	O-XYLENE	NA	--	--	NA	--	--	NA	--	--	NA	--	--
	P-ISOPROPYLTOLUENE	140		100	120		100	110		50	73	J	100
	SEC-BUTYLBENZENE	ND	U	100	ND	U	100	27	J	50	ND	U	100
	TERT-BUTYLBENZENE	ND	U	100	ND	U	100	ND	U	50	ND	U	100
	TETRACHLOROETHENE	NA	--	--	NA	--	--	NA	--	--	NA	--	--
	TOLUENE	6800		100	10000		100	18000		100	19000		200
	TRANS-1,2-DICHLOROETHENE	NA	--	--	NA	--	--	NA	--	--	NA	--	--
	TRICHLOROETHENE	ND	U	100	ND	U	100	ND	U	50	ND	U	100
	TRICHLOROFUOROMETHANE	ND	U	100	ND	U	100	ND	U	50	ND	U	100
	VINYL CHLORIDE	NA	--	--	NA	--	--	NA	--	--	NA	--	--
XYLENES	3200		50	3800		50	5900		25	6000		50	

Refer to notes at the end of the table.

Table 7
Analytical Data Table for KAFB-106063

Phase Designation		Phase 4 Passive											
Sample ID		106063-P4P-011719			106063-LTM-031120			106063-LTM-051920			106063-LTM-051920-FD		
Sample Date		1/17/2019			3/11/2020			5/19/2020			5/19/2020		
Sample Purpose		REG			REG			REG			FD		
Chemical Class and Analytical Method ^a	Parameter	Result	Val Qual	LOQ	Result	Val Qual	LOQ	Result	Val Qual	LOQ	Result	Val Qual	LOQ
Microbial Community (cells/mL) QuantArray-Chlor	1,1 DCA Reductase (DCA)	ND	U	5.3	ND	U	5	ND	U	4.8	NS	--	--
	1,2 DCA Reductase (DCAR)	ND	U	5.3	ND	U	5	ND	U	4.8	NS	--	--
	BAV1 Vinyl Chloride Reductase (BVC)	ND	U	0.5	ND	U	0.5	ND	U	0.5	NS	--	--
	cer A Reductase	ND	U	5.3	ND	U	5	ND	U	4.8	NS	--	--
	Chloroform Reductase (CFR)	ND	U	5.3	ND	U	5	ND	U	4.8	NS	--	--
	Dehalobacter DCM (DCM)	ND	U	5.3	55.6		5	93.7		4.8	NS	--	--
	Dehalobacter spp. (DHBt)	376000		5.3	76900		5	121000		4.8	NS	--	--
	Dehalobium chloroocercia (DECO)	3370		5.3	1880		5	1420		4.8	NS	--	--
	Dehalococcoides (DHC)	0.6		0.5	2.2		0.5	0.7		0.5	NS	--	--
	Dehalogenimonas spp. (DHG)	ND	U	5.3	ND	U	5	ND	U	4.8	NS	--	--
	Desulfotobacterium spp. (DSB)	91800		5.3	19700		5	47200		4.8	NS	--	--
	Desulfuromonas spp. (DSM)	20		5.3	ND	U	5	ND	U	4.8	NS	--	--
	Dichloromethane Dehalogenase (DCMA)	ND	U	5.3	ND	U	5	ND	U	4.8	NS	--	--
	Epoxyalkane Transferase (EtnE)	ND	U	5.3	ND	U	5	ND	U	4.8	NS	--	--
	Ethene Monooxygenase (EtnC)	ND	U	5.3	ND	U	5	ND	U	4.8	NS	--	--
	Methanogens (MGN)	1060		5.3	42800		5	18200		4.8	NS	--	--
	PCE Reductase (PCE-1)	ND	U	5.3	ND	U	5	ND	U	4.8	NS	--	--
	Phenol Hydroxylase (PHE)	1360		5.3	162		5	623		4.8	NS	--	--
	PMMO	NA	--	--	NA	--	--	NA	--	--	NS	--	--
	Soluble Methane Monooxygenase (SMMO)	1960		5.3	2840		5	558		4.8	NS	--	--
	Sulfate Reducing Bacteria (APS)	142000		5.3	32600		5	17300		4.8	NS	--	--
	tceA Reductase (TCE)	ND	U	0.5	ND	U	0.5	ND	U	0.5	NS	--	--
	Toluene Dioxygenase (TOD)	ND	U	5.3	ND	U	5	ND	U	4.8	NS	--	--
	Toluene Monooxygenase (RMO)	8780		5.3	1020		5	3640		4.8	NS	--	--
	Toluene Monooxygenase 2 (RDEG)	3180		5.3	388		5	1410		4.8	NS	--	--
Total Eubacteria (EBAC)	19600000		5.3	7630000		5	12700000		4.8	NS	--	--	
trans-1,2-DCE Reductase (TDR)	ND	U	5.3	ND	U	5	ND	U	4.8	NS	--	--	
Trichlorobenzene Dioxygenase (TCBO)	ND	U	5.3	ND	U	5	ND	U	4.8	NS	--	--	
Vinyl Chloride Reductase (VCR)	ND	U	0.5	0.2	J	0.5	ND	U	0.5	NS	--	--	
EDB (µg/L) EPA Method 8011	1,2-DIBROMOETHANE	0.84		0.0031	ND	U	0.011	ND	U	0.01	ND	U	0.01
VFAs (mg/L) EPA Method 300m	ACETIC ACID	39.9		10	11.6		10	5.7	J	10	6.2	J	10
	BUTYRIC ACID	ND	U	1	ND	U	1	ND	U	10	ND	U	10
	FORMIC ACID	0.3	J	1	0.5	J	10	0.5	J	10	0.2	J	10
	LACTIC ACID	0.5	J	1	0.8	J	10	ND	U	10	ND	U	10
	PROPIONIC ACID	ND	U	1	ND	U	1	ND	U	10	ND	U	10
	PYRUVIC ACID	ND	U	1	ND	U	1	ND	U	10	ND	U	10
	VALERIC ACID	ND	U	1	ND	U	1	ND	U	10	ND	U	10
Fluorometric (µg/L) Spectrofluorophotometry	FLUORESCCEIN	NS	--	--	NS	--	--	NS	--	--	NS	--	--
Reduced Gases (µg/L) RSKSOP-175	ACETYLENE	ND	U	10	10		10	ND	U	10	ND	U	10
	ETHANE	ND	U	4	ND	U	4	1.5	J	4	1.4	J	4
	ETHYLENE	16.2		5	0.9	J	5	14.7		5	14.8		5
	METHANE	777.8		2	3452.3		2	7891.9		2	7565.4		2
	PROPANE	ND	U	6	ND	U	6	0.9	J	6	1	J	6

Table 7
Analytical Data Table for KAFB-106063

Phase Designation		Phase 4 Passive											
Sample ID		106063-P4P-011719			106063-LTM-031120			106063-LTM-051920			106063-LTM-051920-FD		
Sample Date		1/17/2019			3/11/2020			5/19/2020			5/19/2020		
Sample Purpose		REG			REG			REG			FD		
Chemical Class and Analytical Method ^a	Parameter	Result	Val Qual	LOQ	Result	Val Qual	LOQ	Result	Val Qual	LOQ	Result	Val Qual	LOQ
General Chemistry (mg/L) SM2320b, EPA Method 300, EPA Method 353.2, SM4500 PE ^c	ALKALINITY	430		5	576		5	566		5	569		5
	BROMIDE	0.73		0.5	1.04		0.1	0.929		0.1	0.923		0.1
	CHLORIDE	48		0.5	51.9		0.5	51.5		0.5	50.9		0.5
	IODIDE	12	J+	1.5	7		0.2	7	J-	0.2	7	J-	0.2
	NITRATE	NA	--	--	0.0608	J	0.1	0.0668	J-	0.1	0.0656	J-	0.1
	NITRITE	NA	--	--	NA	--	--	NA	--	--	NA	--	--
	NITROGEN, NITRATE-NITRITE	ND	UJ	0.05	ND	U	0.1	ND	UJ	0.1	ND	UJ	0.1
	O-PHOSPHATE (AS P)	NA	--	--	NA	--	--	NA	--	--	NA	--	--
	ORTHOPHOSPHATE	ND	UJ	0.15	NA	--	--	NA	--	--	NA	--	--
	PHOSPHORUS	NA	--	--	0.01	J	0.025	ND	UJ	0.025	ND	UJ	0.025
SULFATE	ND	U	1	ND	U	0.5	ND	U	0.5	ND	U	0.5	
Metals (mg/L) EPA Method 6010	LEAD	NS	--	--	ND	U	0.001	ND	U	0.001	ND	U	0.001
Dissolved Metals (mg/L) EPA Method 6010	IRON	7.3		0.05	6.11		0.05	6.41		0.05	6.75		0.05
	MANGANESE	5.5		0.003	5.72		0.125	6.07		0.125	6.62		0.125
δ2H (‰) Mass Spectrometry, USGS Reston, VA	DELTA2H	NS	--	--	NS	--	--	NS	--	--	NS	--	--
VOCs (µg/L) EPA Method 8260	1,1,2-TRICHLOROETHANE	ND	U	500	ND	U	5	ND	U	10	ND	U	10
	1,2,4-TRICHLOROBENZENE	NA	--	--	ND	U	5	ND	U	10	ND	U	10
	1,2,4-TRIMETHYLBENZENE	520	J	1000	NA	--	--	NA	--	--	NA	--	--
	1,2-DIBROMOETHANE	ND	U	1000	ND	U	5	ND	U	5	ND	U	5
	1,2-DICHLOROETHANE	NA	--	--	ND	U	5	ND	U	5	ND	U	5
	1,3,5-TRIMETHYLBENZENE	ND	U	500	180		5	160		10	140		10
	2-BUTANONE	ND	U	10000	ND	U	10	ND	U	10	ND	U	10
	2-CHLOROTOLUENE	ND	U	500	ND	U	5	ND	U	10	ND	U	10
	2-HEXANONE	ND	U	5000	ND	U	10	ND	U	20	ND	U	20
	4-METHYL-2-PENTANONE	ND	U	5000	ND	U	10	84		20	83		20
	ACETONE	ND	U	10000	ND	U	10	ND	U	10	ND	U	10
	BENZENE	5000		1000	6400		50	5200		50	5100		50
	CARBON DISULFIDE	ND	U	2000	ND	U	10	ND	U	10	ND	U	10
	CHLOROMETHANE	ND	U	1000	ND	U	5	ND	U	5	ND	U	5
	CIS-1,2-DICHLOROETHENE	NA	--	--	ND	U	5	ND	U	5	ND	U	5
	DICHLORODIFLUOROMETHANE	NA	--	--	ND	U	5	ND	U	10	ND	U	10
	ETHYLBENZENE	NA	--	--	1600		5	1700		10	1600		10
	ISOPROPYLBENZENE	ND	U	1000	200		5	200		10	180		10
	M,P-XYLENES	NA	--	--	2900		10	3400		10	3000		10
	METHYL TERT-BUTYL ETHER	ND	U	500	ND	U	5	ND	U	5	ND	U	5
	METHYLENE CHLORIDE	ND	U	5000	ND	U	10	ND	U	10	ND	U	10
	NAPHTHALENE	ND	U	5000	140		5	150		10	120		10
	N-BUTYLBENZENE	ND	U	1000	ND	U	5	25		10	20		10
	N-PROPYLBENZENE	ND	U	1000	150		5	150		10	130		10
	O-XYLENE	NA	--	--	1500		5	1600		10	1400		10
	P-ISOPROPYLTOLUENE	ND	U	1000	ND	U	5	ND	U	10	ND	U	10
	SEC-BUTYLBENZENE	ND	U	1000	25		5	25		10	21		10
	TERT-BUTYLBENZENE	ND	U	1000	ND	U	5	ND	U	10	ND	U	10
	TETRACHLOROETHENE	NA	--	--	ND	U	5	ND	U	10	ND	U	10
	TOLUENE	16000		1000	15000		50	18000		50	17000		50
	TRANS-1,2-DICHLOROETHENE	NA	--	--	ND	U	5	ND	U	5	ND	U	5
	TRICHLOROETHENE	ND	U	1000	ND	U	5	ND	U	5	ND	U	5
	TRICHLOROFUOROMETHANE	ND	U	1000	ND	U	5	ND	U	10	ND	U	10
	VINYL CHLORIDE	NA	--	--	ND	U	5	ND	U	5	ND	U	5
	XYLENES	5200		500	4400		5	4900		10	4500		10

Refer to notes at the end of the table.

Table 7
Analytical Data Table for KAFB-106063

Phase Designation		Phase 4 Passive					
Sample ID		106063-LTM-080420			106063-LTM-101420		
Sample Date		8/4/2020			10/14/2020		
Sample Purpose		REG			REG		
Chemical Class and Analytical Method ^a	Parameter	Result	Val Qual	LOQ	Result	Val Qual	LOQ
Microbial Community (cells/mL) QuantArray-Chlor	1,1 DCA Reductase (DCA)	ND	U	4.9	4.6		4.6
	1,2 DCA Reductase (DCAR)	ND	U	4.9	4.6		4.6
	BAV1 Vinyl Chloride Reductase (BVC)	ND	U	0.5	0.5		0.5
	cer A Reductase	ND	U	4.9	4.6		4.6
	Chloroform Reductase (CFR)	ND	U	4.9	4.6		4.6
	Dehalobacter DCM (DCM)	ND	U	4.9	160		4.6
	Dehalobacter spp. (DHBt)	148000		4.9	320000		4.6
	Dehalobium chlorocoercia (DECO)	1250		4.9	3750		4.6
	Dehalococcoides (DHC)	0.5	J	0.5	2.5		0.5
	Dehalogenimonas spp. (DHG)	ND	U	4.9	4.6		4.6
	Desulfitobacterium spp. (DSB)	74700		4.9	187000		4.6
	Desulfuromonas spp. (DSM)	ND	U	4.9	4.7		4.6
	Dichloromethane Dehalogenase (DCMA)	ND	U	4.9	4.6		4.6
	Epoxyalkane Transferase (EtnE)	ND	U	4.9	4.6		4.6
	Ethene Monooxygenase (EtnC)	ND	U	4.9	4.6		4.6
	Methanogens (MGN)	35300		4.9	31500		4.6
	PCE Reductase (PCE-1)	ND	U	4.9	4.6		4.6
	Phenol Hydroxylase (PHE)	144		4.9	7740		4.6
	PMMO	NA	--	--	NA	--	--
	Soluble Methane Monooxygenase (SMMO)	781		4.9	24.7		4.6
	Sulfate Reducing Bacteria (APS)	20900		4.9	157000		4.6
	tceA Reductase (TCE)	ND	U	0.5	0.5		0.5
	Toluene Dioxygenase (TOD)	ND	U	4.9	4.6		4.6
	Toluene Monooxygenase (RMO)	1020		4.9	6860		4.6
	Toluene Monooxygenase 2 (RDEG)	1210		4.9	14800		4.6
	Total Eubacteria (EBAC)	3940000		4.9	37200000		4.6
	trans-1,2-DCE Reductase (TDR)	ND	U	4.9	4.6		4.6
Trichlorobenzene Dioxygenase (TCBO)	ND	U	4.9	4.6		4.6	
Vinyl Chloride Reductase (VCR)	ND	U	0.5	0.2		0.5	
EDB (µg/L) EPA Method 8011	1,2-DIBROMOETHANE	ND	U	0.01	ND	U	0.01
VFAs (mg/L) EPA Method 300m	ACETIC ACID	2.9	J	10	0.4		10
	BUTYRIC ACID	ND	U	10	ND	U	10
	FORMIC ACID	2.1	J	10	1.8	J	10
	LACTIC ACID	ND	U	10	0.9	J	10
	PROPIONIC ACID	ND	U	10	ND	U	10
	PYRUVIC ACID	ND	U	10	ND	U	10
Fluorometric (µg/L) Spectrofluorophotometry	VALERIC ACID	ND	U	10	ND	U	10
	FLUORESCEIN	NS	--	--	NS	--	--
Reduced Gases (µg/L) RSKSOP-175	ACETYLENE	ND	U	10	ND	U	10
	ETHANE	2.1	J	4	0.7	J	4
	ETHYLENE	14.9		5	6.4		5
	METHANE	4513.7		2	933.4		20
	PROPANE	1.3	J	6	ND	U	6

**Table 7
Analytical Data Table for KAFB-106063**

Phase Designation		Phase 4 Passive					
Sample ID		106063-LTM-080420			106063-LTM-101420		
Sample Date		8/4/2020			10/14/2020		
Sample Purpose		REG			REG		
Chemical Class and Analytical Method ^a	Parameter	Result	Val Qual	LOQ	Result	Val Qual	LOQ
General Chemistry (mg/L) SM2320b, EPA Method 300, EPA Method 353.2, SM4500 PE ^c	ALKALINITY	572		5	479		5
	BROMIDE	2.03		0.1	1.76		0.1
	CHLORIDE	55.5		0.5	46.8		0.5
	IODIDE	9.5		2	8.2		
	NITRATE	0.0597	J	0.1	0.497		0.1
	NITRITE	NA	--	--	NA	--	--
	NITROGEN, NITRATE-NITRITE	ND	U	0.1	ND	U	0.1
	O-PHOSPHATE (AS P)	NA	--	--	NA	--	--
	ORTHOPHOSPHATE	NA	--	--	NA	--	--
	PHOSPHORUS	ND	U	0.025	ND	U	0.025
SULFATE	0.321	J	0.5	0.946		0.5	
Metals (mg/L) EPA Method 6010	LEAD	ND	U	0.001	ND	U	0.001
Dissolved Metals (mg/L) EPA Method 6010	IRON	5.61		0.05	4.25		0.05
	MANGANESE	6.18		0.125	3.79		0.125
δ2H (‰) Mass Spectrometry, USGS Reston, VA	DELTA2H	NS	--	--	NS	--	--
VOCs (µg/L) EPA Method 8260	1,1,2-TRICHLOROETHANE	ND	U	10	ND	U	10
	1,2,4-TRICHLOROBENZENE	ND	U	10	ND	U	10
	1,2,4-TRIMETHYLBENZENE	NA	--	--	NA	--	--
	1,2-DIBROMOETHANE	ND	U	5	ND	U	5
	1,2-DICHLOROETHANE	ND	U	5	ND	U	5
	1,3,5-TRIMETHYLBENZENE	150		10	110		5
	2-BUTANONE	ND	U	10	ND	U	10
	2-CHLOROTOLUENE	ND	U	10	ND	U	10
	2-HEXANONE	ND	U	20	ND	U	20
	4-METHYL-2-PENTANONE	90		20	50		20
	ACETONE	ND	U	10	ND	U	10
	BENZENE	5500		50	3900		50
	CARBON DISULFIDE	ND	U	10	ND	U	20
	CHLOROMETHANE	ND	U	5	ND	U	5
	CIS-1,2-DICHLOROETHENE	ND	U	5	ND	U	5
	DICHLORODIFLUOROMETHANE	ND	U	10	ND	U	5
	ETHYLBENZENE	1600		10	1100		10
	ISOPROPYLBENZENE	210		10	210		5
	M,P-XYLENES	3100		10	2300		10
	METHYL TERT-BUTYL ETHER	ND	U	5	ND	U	5
	METHYLENE CHLORIDE	ND	U	10	ND	U	10
	NAPHTHALENE	160		10	110		5
	N-BUTYLBENZENE	21		10	44		10
	N-PROPYLBENZENE	140		10	93		10
	O-XYLENE	1400		10	1100		10
	P-ISOPROPYLTOLUENE	ND	U	10	ND	U	5
	SEC-BUTYLBENZENE	22		10	15		10
	TERT-BUTYLBENZENE	ND	U	10	ND	U	5
	TETRACHLOROETHENE	ND	U	10	ND	U	10
	TOLUENE	14000		50	1800		5
	TRANS-1,2-DICHLOROETHENE	ND	U	5	ND	U	5
	TRICHLOROETHENE	ND	U	5	ND	U	5
	TRICHLOROFLUOROMETHANE	ND	U	10	ND	U	5
	VINYL CHLORIDE	ND	U	5	ND	U	5
XYLENES	4500		10	3400		10	

Refer to notes at the end of the table.

Table 7
Analytical Data Table for KAFB-106063

Notes:

Sampling frequency for each analytical method is outlined in Table 4.

a. EPA analytical methods listed are for the most recent sampling event.

b. Samples were collected using Geotech Bladder Pumps.

c. Samples were recollected (except for QuantArray-Chlor analysis) using replacement QED Bladder Pumps.

-- = Not applicable.

δ2H - Delta Deuterium.

0/00 - Per mil.

cells/mL = Cells per milliliter.

EPA = Environmental Protection Agency.

FD = Field duplicate.

ID = Identification.

J = Estimated value, concentration is less than LOQ but greater than laboratory method detection limit (DL).

J+ = Estimated value, concentration is less than LOQ but greater than laboratory method detection limit (DL); biased high.

J- = Estimated value, concentration is less than LOQ but greater than laboratory method detection limit (DL); biased low.

KAFB = Kirtland Air Force Base.

LOQ = Limit of Quantitation

µg/L = Microgram per liter.

mg/L = Milligram per liter.

NA = Not analyzed.

ND = Not detected.

NS = Not sampled.

REG = Regular/parent sample.

U = Analyte was not detected. The reported numerical value is at or below the LOQ.

UJ = Analyte was not detected. The reported value is estimated.

VAL QUAL = Validation qualifier.

VFA - Volatile fatty acid.

VOC = Volatile organic compound.

Table 8
Analytical Data Table for KAFB-106064

Phase Designation		Original Baseline ^b			New Baseline - QED Pumps ^c			Phase 1 Recirculation			Phase 1 Recirculation		
Sample ID		106064-BL-081617			106064-BL-091917			106064-P1R-100417			106064-P1R-100417-FD		
Sample Date		8/16/2017			9/19/2017			10/4/2017			10/4/2017		
Sample Purpose		REG			REG			REG			FD		
Chemical Class and Analytical Method ^a	Parameter	Result	Val Qual	LOQ	Result	Val Qual	LOQ	Result	Val Qual	LOQ	Result	Val Qual	LOQ
Microbial Community (cells/mL) QuantArray-Chlor	1,1 DCA Reductase (DCA)	ND	U	6.2	NS	--	--	NS	--	--	NS	--	--
	1,2 DCA Reductase (DCAR)	ND	U	6.2	NS	--	--	NS	--	--	NS	--	--
	BAV1 Vinyl Chloride Reductase (BVC)	ND	U	0.6	NS	--	--	NS	--	--	NS	--	--
	cer A Reductase	NA	--	--	NS	--	--	NS	--	--	NS	--	--
	Chloroform Reductase (CFR)	ND	U	6.2	NS	--	--	NS	--	--	NS	--	--
	Dehalobacter DCM (DCM)	ND	U	6.2	NS	--	--	NS	--	--	NS	--	--
	Dehalobacter spp. (DHBt)	42500		6.2	NS	--	--	NS	--	--	NS	--	--
	Dehalobium chlorocoercia (DECO)	6400		6.2	NS	--	--	NS	--	--	NS	--	--
	Dehalococcoides (DHC)	ND	U	0.6	NS	--	--	NS	--	--	NS	--	--
	Dehalogenimonas spp. (DHG)	ND	U	6.2	NS	--	--	NS	--	--	NS	--	--
	Desulfitobacterium spp. (DSB)	28200		6.2	NS	--	--	NS	--	--	NS	--	--
	Desulfuromonas spp. (DSM)	4890		6.2	NS	--	--	NS	--	--	NS	--	--
	Dichloromethane Dehalogenase (DCMA)	ND	U	6.2	NS	--	--	NS	--	--	NS	--	--
	Epoxyalkane Transferase (EtnE)	ND	U	6.2	NS	--	--	NS	--	--	NS	--	--
	Ethene Monooxygenase (EtnC)	ND	U	6.2	NS	--	--	NS	--	--	NS	--	--
	Methanogens (MGN)	45.3		6.2	NS	--	--	NS	--	--	NS	--	--
	PCE Reductase (PCE-1)	NS	--	--	NS	--	--	NS	--	--	NS	--	--
	Phenol Hydroxylase (PHE)	19200		6.2	NS	--	--	NS	--	--	NS	--	--
	PMMO	ND	U	6.2	NS	--	--	NS	--	--	NS	--	--
	Soluble Methane Monooxygenase (SMMO)	32.3		6.2	NS	--	--	NS	--	--	NS	--	--
	Sulfate Reducing Bacteria (APS)	147000		6.2	NS	--	--	NS	--	--	NS	--	--
	tceA Reductase (TCE)	ND	U	0.6	NS	--	--	NS	--	--	NS	--	--
	Toluene Dioxygenase (TOD)	8.3		6.2	NS	--	--	NS	--	--	NS	--	--
	Toluene Monooxygenase (RMO)	11500		6.2	NS	--	--	NS	--	--	NS	--	--
	Toluene Monooxygenase 2 (RDEG)	11400		6.2	NS	--	--	NS	--	--	NS	--	--
Total Eubacteria (EBAC)	356000		6.2	NS	--	--	NS	--	--	NS	--	--	
trans-1,2-DCE Reductase (TDR)	NA	--	--	NS	--	--	NS	--	--	NS	--	--	
Trichlorobenzene Dioxygenase (TCBO)	ND	U	6.2	NS	--	--	NS	--	--	NS	--	--	
Vinyl Chloride Reductase (VCR)	ND	U	0.6	NS	--	--	NS	--	--	NS	--	--	
EDB (µg/L) EPA Method 8011	1,2-DIBROMOETHANE	6.27		0.385	143	J+	9.67	NS	--	--	NS	--	--
VFAs (mg/L) EPA Method 300m	ACETIC ACID	ND	U	1	15.7		1	NS	--	--	NS	--	--
	BUTYRIC ACID	ND	U	1	ND	U	1	NS	--	--	NS	--	--
	FORMIC ACID	ND	U	1	ND	U	1	NS	--	--	NS	--	--
	LACTIC ACID	ND	U	1	0.51	J	1	NS	--	--	NS	--	--
	PROPIONIC ACID	ND	U	1	1.46		1	NS	--	--	NS	--	--
	PYRUVIC ACID	ND	U	1	ND	U	1	NS	--	--	NS	--	--
	VALERIC ACID	ND	U	1	ND	U	1	NS	--	--	NS	--	--
Fluorometric (µg/L) Spectrofluorophotometry	FLUORESC EIN	ND	U	0.01	ND	U	0.01	ND	U	0.01	ND	U	0.01
Reduced Gases (µg/L) RSKSOP-175	ACETYLENE	ND	U	10	ND	U	10	NS	--	--	NS	--	--
	ETHANE	ND	U	4	1.65	J	4	NS	--	--	NS	--	--
	ETHYLENE	1.09	J	5	17.8		5	NS	--	--	NS	--	--
	METHANE	26		2	179		2	NS	--	--	NS	--	--
	PROPANE	ND	U	6	2.14	J	6	NS	--	--	NS	--	--
General Chemistry (mg/L) SM2320b, EPA Method 300, EPA Method 353.2, SM4500 Pe ^c	ALKALINITY	200		1	354		1	NS	--	--	NS	--	--
	BROMIDE	0.159		0.125	0.283		0.125	NS	--	--	NS	--	--
	CHLORIDE	11.5		0.33	13		0.33	NS	--	--	NS	--	--
	IODIDE	ND	U	0.2	ND	U	0.75	NS	--	--	NS	--	--
	NITRATE	NA	--	--	NA	--	--	NS	--	--	NS	--	--
	NITRITE	NA	--	--	NA	--	--	NS	--	--	NS	--	--
	NITROGEN, NITRATE-NITRITE	ND	U	0.375	ND	U	0.375	NS	--	--	NS	--	--
	O-PHOSPHATE (AS P)	0.0109		0.02	ND	U	0.02	NS	--	--	NS	--	--
	ORTHOPHOSPHATE	NA	--	--	NA	--	--	NS	--	--	NS	--	--
	PHOSPHORUS	NA	--	--	NA	--	--	NS	--	--	NS	--	--
	SULFATE	11.7		1	ND	U	1	NS	--	--	NS	--	--

Table 8
Analytical Data Table for KAFB-106064

Phase Designation		Original Baseline ^b			New Baseline - QED Pumps ^c			Phase 1 Recirculation			Phase 1 Recirculation		
Sample ID		106064-BL-081617			106064-BL-091917			106064-P1R-100417			106064-P1R-100417-FD		
Sample Date		8/16/2017			9/19/2017			10/4/2017			10/4/2017		
Sample Purpose		REG			REG			REG			FD		
Chemical Class and Analytical Method ^a	Parameter	Result	Val Qual	LOQ	Result	Val Qual	LOQ	Result	Val Qual	LOQ	Result	Val Qual	LOQ
Metals (mg/L) EPA Method 6010	LEAD	NS	--	--	NS	--	--	NS	--	--	NS	--	--
Dissolved Metals (mg/L) EPA Method 6010	IRON	0.315	J	0.06	2.62		0.06	NS	--	--	NS	--	--
	MANGANESE	1.21	J-	0.006	2.13		0.006	NS	--	--	NS	--	--
δ2H (‰) Mass Spectrometry, USGS Reston, VA	DELTA2H	-95.99		-99	-94.52		-99	-93.39		-99	-94.11		-99
CSIA EDB δ13C (‰) Kuder et al, 2012	EDB δ	NA	--	--	-11.4 ±2‰	--	--	NS	--	--	NS	--	--
VOCs (µg/L) EPA Method 8260	1,1,2-TRICHLOROETHANE	ND	U	1.25	ND	U	50	NS	--	--	NS	--	--
	1,2,4-TRICHLOROBENZENE	NA	--	--	NA	--	--	NS	--	--	NS	--	--
	1,2,4-TRIMETHYLBENZENE	12.7		1.25	141		50	NS	--	--	NS	--	--
	1,2-DIBROMOETHANE	9.65		1.25	148		50	NS	--	--	NS	--	--
	1,2-DICHLOROETHANE	2.22	J	1.25	ND	U	50	NS	--	--	NS	--	--
	1,3,5-TRIMETHYLBENZENE	ND	U	1.25	37.5	J	50	NS	--	--	NS	--	--
	2-BUTANONE	ND	U	12.5	ND	U	500	NS	--	--	NS	--	--
	2-CHLOROTOLUENE	ND	U	1.25	ND	U	50	NS	--	--	NS	--	--
	2-HEXANONE	ND	U	6.25	ND	U	250	NS	--	--	NS	--	--
	4-METHYL-2-PENTANONE	5.28	J	6.25	ND	U	250	NS	--	--	NS	--	--
	ACETONE	13.7	J+	12.5	ND	U	500	NS	--	--	NS	--	--
	BENZENE	301		1.25	4730		50	NS	--	--	NS	--	--
	CARBON DISULFIDE	ND	U	1.25	ND	U	50	NS	--	--	NS	--	--
	CHLOROMETHANE	ND	U	1.25	ND	U	50	NS	--	--	NS	--	--
	CIS-1,2-DICHLOROETHENE	NA	--	--	NA	--	--	NS	--	--	NS	--	--
	DICHLORODIFLUOROMETHANE	ND	U	2.5	ND	U	100	NS	--	--	NS	--	--
	ETHYLBENZENE	41.9		1.25	577		50	NS	--	--	NS	--	--
	ISOPROPYLBENZENE	6.16		1.25	51.5	J	50	NS	--	--	NS	--	--
	M,P-XYLENES	NA	--	--	NA	--	--	NS	--	--	NS	--	--
	METHYL TERT-BUTYL ETHER	0.717	J	1.25	ND	U	50	NS	--	--	NS	--	--
	METHYLENE CHLORIDE	ND	U	2.5	ND	U	100	NS	--	--	NS	--	--
	NAPHTHALENE	4.96		1.25	56.2	J	50	NS	--	--	NS	--	--
	N-BUTYLBENZENE	0.795	J	1.25	ND	U	50	NS	--	--	NS	--	--
	N-PROPYLBENZENE	5.85		1.25	37.8	J	50	NS	--	--	NS	--	--
	O-XYLENE	NA	--	--	NA	--	--	NS	--	--	NS	--	--
	P-ISOPROPYLTOLUENE	5.06		1.25	31.8	J	50	NS	--	--	NS	--	--
	SEC-BUTYLBENZENE	1.61	J	1.25	ND	U	50	NS	--	--	NS	--	--
	TERT-BUTYLBENZENE	ND	U	1.25	ND	U	50	NS	--	--	NS	--	--
	TETRACHLOROETHENE	NA	--	--	NA	--	--	NS	--	--	NS	--	--
	TOLUENE	92.6		1.25	7330		50	NS	--	--	NS	--	--
	TRANS-1,2-DICHLOROETHENE	NA	--	--	NA	--	--	NS	--	--	NS	--	--
	TRICHLOROETHENE	ND	U	1.25	ND	U	50	NS	--	--	NS	--	--
	TRICHLOROFUOROMETHANE	ND	U	2.5	ND	U	100	NS	--	--	NS	--	--
	VINYL CHLORIDE	NA	--	--	NA	--	--	NS	--	--	NS	--	--
	XYLENES	66		3.75	2010		150	NS	--	--	NS	--	--

Refer to notes at the end of the table.

Table 8
Analytical Data Table for KAFB-106064

Phase Designation		Phase 1 Recirculation			Phase 1 Recirculation			Phase 1 Recirculation			Phase 1 Recirculation		
Sample ID		106064-P1R-100617			106064-P1R-100917			106064-P1R-101217			106064-P1R-101617		
Sample Date		10/6/2017			10/9/2017			10/12/2017			10/16/2017		
Sample Purpose		REG			REG			REG			REG		
Chemical Class and Analytical Method ^a	Parameter	Result	Val Qual	LOQ	Result	Val Qual	LOQ	Result	Val Qual	LOQ	Result	Val Qual	LOQ
Microbial Community (cells/mL) QuantArray-Chlor	1,1 DCA Reductase (DCA)	NS	--	--	NS	--	--	NS	--	--	NS	--	--
	1,2 DCA Reductase (DCAR)	NS	--	--	NS	--	--	NS	--	--	NS	--	--
	BAV1 Vinyl Chloride Reductase (BVC)	NS	--	--	NS	--	--	NS	--	--	NS	--	--
	cer A Reductase	NS	--	--	NS	--	--	NS	--	--	NS	--	--
	Chloroform Reductase (CFR)	NS	--	--	NS	--	--	NS	--	--	NS	--	--
	Dehalobacter DCM (DCM)	NS	--	--	NS	--	--	NS	--	--	NS	--	--
	Dehalobacter spp. (DHBt)	NS	--	--	NS	--	--	NS	--	--	NS	--	--
	Dehalobium chlorocoercia (DECO)	NS	--	--	NS	--	--	NS	--	--	NS	--	--
	Dehalococcoides (DHC)	NS	--	--	NS	--	--	NS	--	--	NS	--	--
	Dehalogenimonas spp. (DHG)	NS	--	--	NS	--	--	NS	--	--	NS	--	--
	Desulfitobacterium spp. (DSB)	NS	--	--	NS	--	--	NS	--	--	NS	--	--
	Desulfuromonas spp. (DSM)	NS	--	--	NS	--	--	NS	--	--	NS	--	--
	Dichloromethane Dehalogenase (DCMA)	NS	--	--	NS	--	--	NS	--	--	NS	--	--
	Epoxyalkane Transferase (EtnE)	NS	--	--	NS	--	--	NS	--	--	NS	--	--
	Ethene Monooxygenase (EtnC)	NS	--	--	NS	--	--	NS	--	--	NS	--	--
	Methanogens (MGN)	NS	--	--	NS	--	--	NS	--	--	NS	--	--
	PCE Reductase (PCE-1)	NS	--	--	NS	--	--	NS	--	--	NS	--	--
	Phenol Hydroxylase (PHE)	NS	--	--	NS	--	--	NS	--	--	NS	--	--
	PMMO	NS	--	--	NS	--	--	NS	--	--	NS	--	--
	Soluble Methane Monooxygenase (SMMO)	NS	--	--	NS	--	--	NS	--	--	NS	--	--
	Sulfate Reducing Bacteria (APS)	NS	--	--	NS	--	--	NS	--	--	NS	--	--
	tceA Reductase (TCE)	NS	--	--	NS	--	--	NS	--	--	NS	--	--
	Toluene Dioxygenase (TOD)	NS	--	--	NS	--	--	NS	--	--	NS	--	--
	Toluene Monooxygenase (RMO)	NS	--	--	NS	--	--	NS	--	--	NS	--	--
	Toluene Monooxygenase 2 (RDEG)	NS	--	--	NS	--	--	NS	--	--	NS	--	--
Total Eubacteria (EBAC)	NS	--	--	NS	--	--	NS	--	--	NS	--	--	
trans-1,2-DCE Reductase (TDR)	NS	--	--	NS	--	--	NS	--	--	NS	--	--	
Trichlorobenzene Dioxygenase (TCBO)	NS	--	--	NS	--	--	NS	--	--	NS	--	--	
Vinyl Chloride Reductase (VCR)	NS	--	--	NS	--	--	NS	--	--	NS	--	--	
EDB (µg/L) EPA Method 8011	1,2-DIBROMOETHANE	NS	--	--	NS	--	--	NS	--	--	NS	--	--
VFAs (mg/L) EPA Method 300m	ACETIC ACID	NS	--	--	NS	--	--	NS	--	--	NS	--	--
	BUTYRIC ACID	NS	--	--	NS	--	--	NS	--	--	NS	--	--
	FORMIC ACID	NS	--	--	NS	--	--	NS	--	--	NS	--	--
	LACTIC ACID	NS	--	--	NS	--	--	NS	--	--	NS	--	--
	PROPIONIC ACID	NS	--	--	NS	--	--	NS	--	--	NS	--	--
	PYRUVIC ACID	NS	--	--	NS	--	--	NS	--	--	NS	--	--
	VALERIC ACID	NS	--	--	NS	--	--	NS	--	--	NS	--	--
Fluorometric (µg/L) Spectrofluorophotometry	FLUORESC EIN	144.5		0.01	33.529		0.01	9.946		0.01	2.504		0.01
Reduced Gases (µg/L) RSKSOP-175	ACETYLENE	NS	--	--	NS	--	--	NS	--	--	NS	--	--
	ETHANE	NS	--	--	NS	--	--	NS	--	--	NS	--	--
	ETHYLENE	NS	--	--	NS	--	--	NS	--	--	NS	--	--
	METHANE	NS	--	--	NS	--	--	NS	--	--	NS	--	--
	PROPANE	NS	--	--	NS	--	--	NS	--	--	NS	--	--
General Chemistry (mg/L) SM2320b, EPA Method 300, EPA Method 353.2, SM4500 Pe ^c	ALKALINITY	NS	--	--	NS	--	--	NS	--	--	NS	--	--
	BROMIDE	NS	--	--	NS	--	--	NS	--	--	NS	--	--
	CHLORIDE	NS	--	--	NS	--	--	NS	--	--	NS	--	--
	IODIDE	NS	--	--	NS	--	--	NS	--	--	NS	--	--
	NITRATE	NS	--	--	NS	--	--	NS	--	--	NS	--	--
	NITRITE	NS	--	--	NS	--	--	NS	--	--	NS	--	--
	NITROGEN, NITRATE-NITRITE	NS	--	--	NS	--	--	NS	--	--	NS	--	--
	O-PHOSPHATE (AS P)	NS	--	--	NS	--	--	NS	--	--	NS	--	--
	ORTHOPHOSPHATE	NS	--	--	NS	--	--	NS	--	--	NS	--	--
	PHOSPHORUS	NS	--	--	NS	--	--	NS	--	--	NS	--	--
	SULFATE	NS	--	--	NS	--	--	NS	--	--	NS	--	--

Table 8
Analytical Data Table for KAFB-106064

Phase Designation		Phase 1 Recirculation			Phase 1 Recirculation			Phase 1 Recirculation			Phase 1 Recirculation		
Sample ID		106064-P1R-100617			106064-P1R-100917			106064-P1R-101217			106064-P1R-101617		
Sample Date		10/6/2017			10/9/2017			10/12/2017			10/16/2017		
Sample Purpose		REG			REG			REG			REG		
Chemical Class and Analytical Method ^a	Parameter	Result	Val Qual	LOQ	Result	Val Qual	LOQ	Result	Val Qual	LOQ	Result	Val Qual	LOQ
Metals (mg/L) EPA Method 6010	LEAD	NS	--	--	NS	--	--	NS	--	--	NS	--	--
Dissolved Metals (mg/L) EPA Method 6010	IRON	NS	--	--	NS	--	--	NS	--	--	NS	--	--
	MANGANESE	NS	--	--	NS	--	--	NS	--	--	NS	--	--
δ2H (‰) Mass Spectrometry, USGS Reston, VA	DELTA2H	123.55		-99	-56.22		-99	-80.18		-99	-91.39		-99
CSIA EDB δ13C (‰) Kuder et al, 2012	EDB δ	NS	--	--	NS	--	--	NS	--	--	NS	--	--
VOCs (µg/L) EPA Method 8260	1,1,2-TRICHLOROETHANE	NS	--	--	NS	--	--	NS	--	--	NS	--	--
	1,2,4-TRICHLOROBENZENE	NS	--	--	NS	--	--	NS	--	--	NS	--	--
	1,2,4-TRIMETHYLBENZENE	NS	--	--	NS	--	--	NS	--	--	NS	--	--
	1,2-DIBROMOETHANE	NS	--	--	NS	--	--	NS	--	--	NS	--	--
	1,2-DICHLOROETHANE	NS	--	--	NS	--	--	NS	--	--	NS	--	--
	1,3,5-TRIMETHYLBENZENE	NS	--	--	NS	--	--	NS	--	--	NS	--	--
	2-BUTANONE	NS	--	--	NS	--	--	NS	--	--	NS	--	--
	2-CHLOROTOLUENE	NS	--	--	NS	--	--	NS	--	--	NS	--	--
	2-HEXANONE	NS	--	--	NS	--	--	NS	--	--	NS	--	--
	4-METHYL-2-PENTANONE	NS	--	--	NS	--	--	NS	--	--	NS	--	--
	ACETONE	NS	--	--	NS	--	--	NS	--	--	NS	--	--
	BENZENE	NS	--	--	NS	--	--	NS	--	--	NS	--	--
	CARBON DISULFIDE	NS	--	--	NS	--	--	NS	--	--	NS	--	--
	CHLOROMETHANE	NS	--	--	NS	--	--	NS	--	--	NS	--	--
	CIS-1,2-DICHLOROETHENE	NS	--	--	NS	--	--	NS	--	--	NS	--	--
	DICHLORODIFLUOROMETHANE	NS	--	--	NS	--	--	NS	--	--	NS	--	--
	ETHYLBENZENE	NS	--	--	NS	--	--	NS	--	--	NS	--	--
	ISOPROPYLBENZENE	NS	--	--	NS	--	--	NS	--	--	NS	--	--
	M,P-XYLENES	NS	--	--	NS	--	--	NS	--	--	NS	--	--
	METHYL TERT-BUTYL ETHER	NS	--	--	NS	--	--	NS	--	--	NS	--	--
	METHYLENE CHLORIDE	NS	--	--	NS	--	--	NS	--	--	NS	--	--
	NAPHTHALENE	NS	--	--	NS	--	--	NS	--	--	NS	--	--
	N-BUTYLBENZENE	NS	--	--	NS	--	--	NS	--	--	NS	--	--
	N-PROPYLBENZENE	NS	--	--	NS	--	--	NS	--	--	NS	--	--
	O-XYLENE	NS	--	--	NS	--	--	NS	--	--	NS	--	--
	P-ISOPROPYLTOLUENE	NS	--	--	NS	--	--	NS	--	--	NS	--	--
	SEC-BUTYLBENZENE	NS	--	--	NS	--	--	NS	--	--	NS	--	--
	TERT-BUTYLBENZENE	NS	--	--	NS	--	--	NS	--	--	NS	--	--
	TETRACHLOROETHENE	NS	--	--	NS	--	--	NS	--	--	NS	--	--
	TOLUENE	NS	--	--	NS	--	--	NS	--	--	NS	--	--
	TRANS-1,2-DICHLOROETHENE	NS	--	--	NS	--	--	NS	--	--	NS	--	--
	TRICHLOROETHENE	NS	--	--	NS	--	--	NS	--	--	NS	--	--
	TRICHLOROFLUOROMETHANE	NS	--	--	NS	--	--	NS	--	--	NS	--	--
	VINYL CHLORIDE	NS	--	--	NS	--	--	NS	--	--	NS	--	--
	XYLENES	NS	--	--	NS	--	--	NS	--	--	NS	--	--

Refer to notes at the end of the table.

Table 8
Analytical Data Table for KAFB-106064

Phase Designation		Phase 1 Recirculation									Phase 1 Passive		
Sample ID		106064-P1R-102017			106064-P1R-102417			106064-P1R-110117			106064-P1P-111517		
Sample Date		10/20/2017			10/24/2017			11/1/2017			11/15/2017		
Sample Purpose		REG			REG			REG			REG		
Chemical Class and Analytical Method ^a	Parameter	Result	Val Qual	LOQ	Result	Val Qual	LOQ	Result	Val Qual	LOQ	Result	Val Qual	LOQ
Microbial Community (cells/mL) QuantArray-Chlor	1,1 DCA Reductase (DCA)	NS	--	--	NS	--	--	NS	--	--	NS	--	--
	1,2 DCA Reductase (DCAR)	NS	--	--	NS	--	--	NS	--	--	NS	--	--
	BAV1 Vinyl Chloride Reductase (BVC)	NS	--	--	NS	--	--	NS	--	--	NS	--	--
	cer A Reductase	NS	--	--	NS	--	--	NS	--	--	NS	--	--
	Chloroform Reductase (CFR)	NS	--	--	NS	--	--	NS	--	--	NS	--	--
	Dehalobacter DCM (DCM)	NS	--	--	NS	--	--	NS	--	--	NS	--	--
	Dehalobacter spp. (DHBt)	NS	--	--	NS	--	--	NS	--	--	NS	--	--
	Dehalobium chlorocoercia (DECO)	NS	--	--	NS	--	--	NS	--	--	NS	--	--
	Dehalococcoides (DHC)	NS	--	--	NS	--	--	NS	--	--	NS	--	--
	Dehalogenimonas spp. (DHG)	NS	--	--	NS	--	--	NS	--	--	NS	--	--
	Desulfitobacterium spp. (DSB)	NS	--	--	NS	--	--	NS	--	--	NS	--	--
	Desulfuromonas spp. (DSM)	NS	--	--	NS	--	--	NS	--	--	NS	--	--
	Dichloromethane Dehalogenase (DCMA)	NS	--	--	NS	--	--	NS	--	--	NS	--	--
	Epoxyalkane Transferase (EtnE)	NS	--	--	NS	--	--	NS	--	--	NS	--	--
	Ethene Monooxygenase (EtnC)	NS	--	--	NS	--	--	NS	--	--	NS	--	--
	Methanogens (MGN)	NS	--	--	NS	--	--	NS	--	--	NS	--	--
	PCE Reductase (PCE-1)	NS	--	--	NS	--	--	NS	--	--	NS	--	--
	Phenol Hydroxylase (PHE)	NS	--	--	NS	--	--	NS	--	--	NS	--	--
	PMMO	NS	--	--	NS	--	--	NS	--	--	NS	--	--
	Soluble Methane Monooxygenase (SMMO)	NS	--	--	NS	--	--	NS	--	--	NS	--	--
	Sulfate Reducing Bacteria (APS)	NS	--	--	NS	--	--	NS	--	--	NS	--	--
	tceA Reductase (TCE)	NS	--	--	NS	--	--	NS	--	--	NS	--	--
	Toluene Dioxygenase (TOD)	NS	--	--	NS	--	--	NS	--	--	NS	--	--
	Toluene Monooxygenase (RMO)	NS	--	--	NS	--	--	NS	--	--	NS	--	--
Toluene Monooxygenase 2 (RDEG)	NS	--	--	NS	--	--	NS	--	--	NS	--	--	
Total Eubacteria (EBAC)	NS	--	--	NS	--	--	NS	--	--	NS	--	--	
trans-1,2-DCE Reductase (TDR)	NS	--	--	NS	--	--	NS	--	--	NS	--	--	
Trichlorobenzene Dioxygenase (TCBO)	NS	--	--	NS	--	--	NS	--	--	NS	--	--	
Vinyl Chloride Reductase (VCR)	NS	--	--	NS	--	--	NS	--	--	NS	--	--	
EDB (µg/L) EPA Method 8011	1,2-DIBROMOETHANE	NS	--	--	76		1.9	NS	--	--	43.1		3.83
VFAs (mg/L) EPA Method 300m	ACETIC ACID	NS	--	--	5.7	U	1	NS	--	--	20.1		1
	BUTYRIC ACID	NS	--	--	ND	U	1	NS	--	--	ND	U	1
	FORMIC ACID	NS	--	--	ND	U	1	NS	--	--	ND	U	1
	LACTIC ACID	NS	--	--	ND	U	1	NS	--	--	ND	U	1
	PROPIONIC ACID	NS	--	--	ND	U	1	NS	--	--	0.68	J	1
	PYRUVIC ACID	NS	--	--	ND	U	1	NS	--	--	ND	U	1
	VALERIC ACID	NS	--	--	ND	U	1	NS	--	--	ND	U	1
Fluorometric (µg/L) Spectrofluorophotometry	FLUORESC EIN	3.289		0.01	4.128		0.01	6.553		0.01	5.942		0.01
Reduced Gases (µg/L) RSKSOP-175	ACETYLENE	NS	--	--	ND	U	10	NS	--	--	ND	U	10
	ETHANE	NS	--	--	ND	U	4	NS	--	--	ND	U	4
	ETHYLENE	NS	--	--	3.18	J	5	NS	--	--	3.46	J	5
	METHANE	NS	--	--	1.9	J	2	NS	--	--	11.4		2
	PROPANE	NS	--	--	ND	U	6	NS	--	--	ND	U	6
General Chemistry (mg/L) SM2320b, EPA Method 300, EPA Method 353.2, SM4500 Pe ^c	ALKALINITY	NS	--	--	317		1	NS	--	--	300		1
	BROMIDE	NS	--	--	0.53		0.125	NS	--	--	0.596		0.25
	CHLORIDE	NS	--	--	44.5		0.33	NS	--	--	44.8		0.66
	IODIDE	NS	--	--	ND	U	0.75	NS	--	--	ND	U	0.75
	NITRATE	NS	--	--	NA	--	--	NS	--	--	NA	--	--
	NITRITE	NS	--	--	NA	--	--	NS	--	--	NA	--	--
	NITROGEN, NITRATE-NITRITE	NS	--	--	ND	U	0.375	NS	--	--	ND	U	0.375
	O-PHOSPHATE (AS P)	NS	--	--	ND	U	0.02	NS	--	--	0.019	J	0.02
	ORTHOPHOSPHATE	NS	--	--	NA	--	--	NS	--	--	NA	--	--
	PHOSPHORUS	NS	--	--	NA	--	--	NS	--	--	NA	--	--
	SULFATE	NS	--	--	13.8		1	NS	--	--	ND	U	2

**Table 8
Analytical Data Table for KAFB-106064**

Phase Designation		Phase 1 Recirculation									Phase 1 Passive		
Sample ID		106064-P1R-102017			106064-P1R-102417			106064-P1R-110117			106064-P1P-111517		
Sample Date		10/20/2017			10/24/2017			11/1/2017			11/15/2017		
Sample Purpose		REG			REG			REG			REG		
Chemical Class and Analytical Method ^a	Parameter	Result	Val Qual	LOQ	Result	Val Qual	LOQ	Result	Val Qual	LOQ	Result	Val Qual	LOQ
Metals (mg/L) EPA Method 6010	LEAD	NS	--	--	NS	--	--	NS	--	--	NS	--	--
Dissolved Metals (mg/L) EPA Method 6010	IRON	NS	--	--	0.689		0.06	NS	--	--	1.04		0.06
	MANGANESE	NS	--	--	2.11		0.006	NS	--	--	2.53		0.006
δ2H (‰) Mass Spectrometry, USGS Reston, VA	DELTA2H	-90.18		-99	-90.67		-99	-85.04		-99	-88.46		-99
CSIA EDB δ13C (‰) Kuder et al, 2012	EDB δ	NS	--	--	NS	--	--	NS	--	--	NS	--	--
VOCs (µg/L) EPA Method 8260	1,1,2-TRICHLOROETHANE	NS	--	--	ND	U	50	NS	--	--	ND	U	50
	1,2,4-TRICHLOROBENZENE	NS	--	--	NA	--	--	NS	--	--	NA	--	--
	1,2,4-TRIMETHYLBENZENE	NS	--	--	350		50	NS	--	--	344		50
	1,2-DIBROMOETHANE	NS	--	--	76.7	J	50	NS	--	--	49.9	J	50
	1,2-DICHLOROETHANE	NS	--	--	ND	U	50	NS	--	--	ND	U	50
	1,3,5-TRIMETHYLBENZENE	NS	--	--	111		50	NS	--	--	122		50
	2-BUTANONE	NS	--	--	ND	U	500	NS	--	--	ND	U	500
	2-CHLOROTOLUENE	NS	--	--	ND	U	50	NS	--	--	ND	U	50
	2-HEXANONE	NS	--	--	170	J	250	NS	--	--	142	J	250
	4-METHYL-2-PENTANONE	NS	--	--	ND	U	250	NS	--	--	ND	U	250
	ACETONE	NS	--	--	ND	U	500	NS	--	--	ND	U	500
	BENZENE	NS	--	--	3140		50	NS	--	--	3850		50
	CARBON DISULFIDE	NS	--	--	ND	U	50	NS	--	--	ND	U	50
	CHLOROMETHANE	NS	--	--	ND	U	50	NS	--	--	ND	U	50
	CIS-1,2-DICHLOROETHENE	NS	--	--	NA	--	--	NS	--	--	NA	--	--
	DICHLORODIFLUOROMETHANE	NS	--	--	ND	U	100	NS	--	--	ND	U	100
	ETHYLBENZENE	NS	--	--	894		50	NS	--	--	1470		50
	ISOPROPYLBENZENE	NS	--	--	77.9	J	50	NS	--	--	149		50
	M,P-XYLENES	NS	--	--	NA	--	--	NS	--	--	NA	--	--
	METHYL TERT-BUTYL ETHER	NS	--	--	ND	U	50	NS	--	--	ND	U	50
	METHYLENE CHLORIDE	NS	--	--	ND	U	100	NS	--	--	ND	U	100
	NAPHTHALENE	NS	--	--	105		50	NS	--	--	139		50
	N-BUTYLBENZENE	NS	--	--	ND	U	50	NS	--	--	ND	U	50
	N-PROPYLBENZENE	NS	--	--	72.7	J	50	NS	--	--	103		50
	O-XYLENE	NS	--	--	NA	--	--	NS	--	--	NA	--	--
	P-ISOPROPYLTOLUENE	NS	--	--	51.2	J	50	NS	--	--	101		50
	SEC-BUTYLBENZENE	NS	--	--	ND	U	50	NS	--	--	ND	U	50
	TERT-BUTYLBENZENE	NS	--	--	ND	U	50	NS	--	--	ND	U	50
	TETRACHLOROETHENE	NS	--	--	NA	--	--	NS	--	--	NA	--	--
	TOLUENE	NS	--	--	7540		50	NS	--	--	16900		50
	TRANS-1,2-DICHLOROETHENE	NS	--	--	NA	--	--	NS	--	--	NA	--	--
	TRICHLOROETHENE	NS	--	--	ND	U	50	NS	--	--	ND	U	50
	TRICHLOROFLUOROMETHANE	NS	--	--	ND	U	100	NS	--	--	ND	U	100
	VINYL CHLORIDE	NS	--	--	NA	--	--	NS	--	--	NA	--	--
	XYLENES	NS	--	--	3350		150	NS	--	--	4270		150

Refer to notes at the end of the table.

Table 8
Analytical Data Table for KAFB-106064

Phase Designation		Phase 1 Passive			Phase 2 Recirculation						Phase 2 Recirculation		
Sample ID		106064-P1P-112817			106064-P2R-011018			106064-P2R-011818			106064-P2R-012518		
Sample Date		11/28/2017			1/10/2018			1/18/2018			1/25/2018		
Sample Purpose		REG			REG			REG			REG		
Chemical Class and Analytical Method ^a	Parameter	Result	Val Qual	LOQ	Result	Val Qual	LOQ	Result	Val Qual	LOQ	Result	Val Qual	LOQ
Microbial Community (cells/mL) QuantArray-Chlor	1,1 DCA Reductase (DCA)	ND	U	4.9	NS	--	--	NS	--	--	ND	U	10.4
	1,2 DCA Reductase (DCAR)	ND	U	4.9	NS	--	--	NS	--	--	ND	U	10.4
	BAV1 Vinyl Chloride Reductase (BVC)	ND	U	0.5	NS	--	--	NS	--	--	ND	U	1
	cer A Reductase	NA	--	--	NS	--	--	NS	--	--	ND	U	10.4
	Chloroform Reductase (CFR)	ND	U	4.9	NS	--	--	NS	--	--	ND	U	10.4
	Dehalobacter DCM (DCM)	ND	U	4.9	NS	--	--	NS	--	--	ND	U	10.4
	Dehalobacter spp. (DHBt)	84200		4.9	NS	--	--	NS	--	--	119000		10.4
	Dehalobium chlorocoercia (DECO)	4520		4.9	NS	--	--	NS	--	--	23600		10.4
	Dehalococcoides (DHC)	0.6		0.5	NS	--	--	NS	--	--	ND	U	1
	Dehalogenimonas spp. (DHG)	ND	U	4.9	NS	--	--	NS	--	--	ND	U	10.4
	Desulfitobacterium spp. (DSB)	103000		4.9	NS	--	--	NS	--	--	89700		10.4
	Desulfuromonas spp. (DSM)	5		4.9	NS	--	--	NS	--	--	10.7		10.4
	Dichloromethane Dehalogenase (DCMA)	ND	U	4.9	NS	--	--	NS	--	--	ND	U	10.4
	Epoxyalkane Transferase (EtnE)	ND	U	4.9	NS	--	--	NS	--	--	ND	U	10.4
	Ethene Monooxygenase (EtnC)	ND	U	4.9	NS	--	--	NS	--	--	ND	U	10.4
	Methanogens (MGN)	75.4		4.9	NS	--	--	NS	--	--	228		10.4
	PCE Reductase (PCE-1)	NA	--	--	NS	--	--	NS	--	--	4.3	J	10.4
	Phenol Hydroxylase (PHE)	6760		4.9	NS	--	--	NS	--	--	17400		10.4
	PMMO	69.7		4.9	NS	--	--	NS	--	--	NA	--	--
	Soluble Methane Monooxygenase (SMMO)	422		4.9	NS	--	--	NS	--	--	590		10.4
	Sulfate Reducing Bacteria (APS)	96100		4.9	NS	--	--	NS	--	--	298000		10.4
	tceA Reductase (TCE)	ND	U	0.5	NS	--	--	NS	--	--	ND	U	1
	Toluene Dioxygenase (TOD)	ND	U	4.9	NS	--	--	NS	--	--	ND	U	10.4
	Toluene Monooxygenase (RMO)	22100		4.9	NS	--	--	NS	--	--	17800		10.4
	Toluene Monooxygenase 2 (RDEG)	8480		4.9	NS	--	--	NS	--	--	8300		10.4
Total Eubacteria (EBAC)	6130000		4.9	NS	--	--	NS	--	--	22700000		10.4	
trans-1,2-DCE Reductase (TDR)	NA	--	--	NS	--	--	NS	--	--	ND	U	10.4	
Trichlorobenzene Dioxygenase (TCBO)	ND	U	4.9	NS	--	--	NS	--	--	ND	U	10.4	
Vinyl Chloride Reductase (VCR)	0.3	J	0.5	NS	--	--	NS	--	--	ND	U	1	
EDB (µg/L) EPA Method 8011	1,2-DIBROMOETHANE	20.3		1.91	69.9		1.9	65		1.88	80.3	J+	1.9
VFAs (mg/L) EPA Method 300m	ACETIC ACID	21		1	73		1	79.8		1	44.9		1
	BUTYRIC ACID	ND	U	1	ND	U	1	1.05		1	0.74	J	1
	FORMIC ACID	ND	U	1	ND	U	1	ND	U	1	ND	U	1
	LACTIC ACID	ND	U	1	3.02		1	2.59		1	0.72	J	1
	PROPIONIC ACID	0.57	J	1	13		1	20.3		1	10.5		1
	PYRUVIC ACID	ND	U	1	ND	U	1	ND	U	1	ND	U	1
	VALERIC ACID	ND	U	1	ND	U	1	ND	U	1	ND	U	1
Fluorometric (µg/L) Spectrofluorophotometry	FLUORESC EIN	5.489		0.01	NS	--	--	NS	--	--	NS	--	--
Reduced Gases (µg/L) RSKSOP-175	ACETYLENE	ND	U	10	ND	U	10	ND	U	10	ND	U	10
	ETHANE	ND	U	4	2.01	J	4	1.82	J	4	2.86		4
	ETHYLENE	5.07		5	6.46		5	ND	U	5	9.47		5
	METHANE	20.5		2	15		2	16.5		2	25.3		2
	PROPANE	ND	U	6	1.93	J	6	2.23	J	6	3.21	J	6
General Chemistry (mg/L) SM2320b, EPA Method 300, EPA Method 353.2, SM4500 Pe ^c	ALKALINITY	312		1	354		1	341		1	352		1
	BROMIDE	0.654		0.25	0.565		0.25	0.644		0.25	0.606		0.125
	CHLORIDE	45.7		0.66	53.3		0.66	53.7		0.66	48.6		0.66
	IODIDE	ND	U	0.75	11		0.75	13		0.75	18		0.75
	NITRATE	NA	--	--	NA	--	--	NA	--	--	NA	--	--
	NITRITE	NA	--	--	NA	--	--	NA	--	--	NA	--	--
	NITROGEN, NITRATE-NITRITE	ND	U	0.375	ND	U	0.375	ND	U	0.375	ND	U	0.375
	O-PHOSPHATE (AS P)	ND	U	0.02	1.12		0.04	1.92		0.04	1.72		0.1
	ORTHOPHOSPHATE	NA	--	--	NA	--	--	NA	--	--	NA	--	--
	PHOSPHORUS	NA	--	--	NA	--	--	NA	--	--	NA	--	--
	SULFATE	ND	U	2	ND	U	2	ND	U	2	ND	U	2

Table 8
Analytical Data Table for KAFB-106064

Phase Designation		Phase 1 Passive			Phase 2 Recirculation						Phase 2 Recirculation		
Sample ID		106064-P1P-112817			106064-P2R-011018			106064-P2R-011818			106064-P2R-012518		
Sample Date		11/28/2017			1/10/2018			1/18/2018			1/25/2018		
Sample Purpose		REG			REG			REG			REG		
Chemical Class and Analytical Method ^a	Parameter	Result	Val Qual	LOQ	Result	Val Qual	LOQ	Result	Val Qual	LOQ	Result	Val Qual	LOQ
Metals (mg/L) EPA Method 6010	LEAD	NS	--	--	NS	--	--	NS	--	--	NS	--	--
Dissolved Metals (mg/L) EPA Method 6010	IRON	1.67		0.06	4.67		0.06	1.31		0.06	1.76	J-	0.06
	MANGANESE	2.72		0.006	0.777		0.006	3.69		0.006	3.75	J-	0.006
δ2H (‰) Mass Spectrometry, USGS Reston, VA	DELTA2H	-87.46		-99	NS	--	--	NS	--	--	NS	--	--
CSIA EDB δ13C (‰) Kuder et al, 2012	EDB δ	-1.3 ±2‰	--	--	NS	--	--	NS	--	--	-9.3 ±2‰	--	--
VOCs (µg/L) EPA Method 8260	1,1,2-TRICHLOROETHANE	ND	U	125	ND	U	50	ND	U	50	ND	U	50
	1,2,4-TRICHLOROBENZENE	NA	--	--	NA	--	--	NA	--	--	NA	--	--
	1,2,4-TRIMETHYLBENZENE	488		125	342		50	274		50	398		50
	1,2-DIBROMOETHANE	ND	U	125	63.6	J	50	59.5	J	50	62.8	J	50
	1,2-DICHLOROETHANE	ND	U	125	ND	U	50	ND	U	50	ND	U	50
	1,3,5-TRIMETHYLBENZENE	171	J	125	126		50	97.8	J	50	149		50
	2-BUTANONE	ND	U	1250	ND	U	500	ND	U	500	ND	U	500
	2-CHLOROTOLUENE	ND	U	125	ND	U	50	ND	U	50	ND	U	50
	2-HEXANONE	ND	U	625	ND	U	250	ND	U	250	ND	U	250
	4-METHYL-2-PENTANONE	ND	U	625	ND	U	250	ND	U	250	ND	U	250
	ACETONE	ND	U	1250	447	J	500	418	J	500	265	J	500
	BENZENE	3680		125	3950		50	3700		50	4070		50
	CARBON DISULFIDE	ND	U	125	ND	U	50	ND	U	50	ND	U	50
	CHLOROMETHANE	ND	U	125	64.8		50	ND	U	50	ND	U	50
	CIS-1,2-DICHLOROETHENE	NA	--	--	NA	--	--	NA	--	--	NA	--	--
	DICHLORODIFLUOROMETHANE	ND	U	250	ND	U	100	ND	U	100	ND	U	100
	ETHYLBENZENE	2040		125	1010		50	956		50	1180		50
	ISOPROPYLBENZENE	192	J	125	97.4	J	50	89.1	J	50	96.8	J	50
	M,P-XYLENES	NA	--	--	NA	--	--	NA	--	--	NA	--	--
	METHYL TERT-BUTYL ETHER	ND	U	125	ND	U	50	ND	U	50	ND	U	50
	METHYLENE CHLORIDE	ND	U	250	55.6	J	100	ND	U	100	ND	U	100
	NAPHTHALENE	132	J	125	106		50	125		50	100		50
	N-BUTYLBENZENE	ND	U	125	ND	U	50	ND	U	50	ND	U	50
	N-PROPYLBENZENE	147	J	125	93.3	J	50	93.3	J	50	103		50
	O-XYLENE	NA	--	--	NA	--	--	NA	--	--	NA	--	--
	P-ISOPROPYLTOLUENE	148	J	125	98.8	J	50	81.5	J	50	ND	U	50
	SEC-BUTYLBENZENE	ND	U	125	ND	U	50	ND	U	50	ND	U	50
	TERT-BUTYLBENZENE	ND	U	125	ND	U	50	ND	U	50	ND	U	50
	TETRACHLOROETHENE	NA	--	--	NA	--	--	NA	--	--	NA	--	--
	TOLUENE	19500		125	9200		50	9850		50	11300		50
	TRANS-1,2-DICHLOROETHENE	NA	--	--	NA	--	--	NA	--	--	NA	--	--
	TRICHLOROETHENE	ND	U	125	ND	U	50	ND	U	50	ND	U	50
	TRICHLOROFUOROMETHANE	ND	U	250	ND	U	100	ND	U	100	ND	U	100
	VINYL CHLORIDE	NA	--	--	NA	--	--	NA	--	--	NA	--	--
	XYLENES	5730		375	3180		150	3020		150	3740		150

Refer to notes at the end of the table.

Table 8
Analytical Data Table for KAFB-106064

Phase Designation		Phase 2 Passive						Phase 2 Passive					
Sample ID		106064-P2P-030718			106064-P2P-041018			106064-P2P-050918			106064-P2P-050918-FD		
Sample Date		3/7/2018			4/10/2018			5/9/2018			5/9/2018		
Sample Purpose		REG			REG			REG			FD		
Chemical Class and Analytical Method ^a	Parameter	Result	Val Qual	LOQ	Result	Val Qual	LOQ	Result	Val Qual	LOQ	Result	Val Qual	LOQ
Microbial Community (cells/mL) QuantArray-Chlor	1,1 DCA Reductase (DCA)	NS	--	--	NS	--	--	ND	U	9.1	NS	--	--
	1,2 DCA Reductase (DCAR)	NS	--	--	NS	--	--	ND	U	9.1	NS	--	--
	BAV1 Vinyl Chloride Reductase (BVC)	NS	--	--	NS	--	--	ND	U	0.9	NS	--	--
	cer A Reductase	NS	--	--	NS	--	--	ND	U	9.1	NS	--	--
	Chloroform Reductase (CFR)	NS	--	--	NS	--	--	ND	U	9.1	NS	--	--
	Dehalobacter DCM (DCM)	NS	--	--	NS	--	--	11800		9.1	NS	--	--
	Dehalobacter spp. (DHBt)	NS	--	--	NS	--	--	132000		9.1	NS	--	--
	Dehalobium chlorocoercia (DECO)	NS	--	--	NS	--	--	23100		9.1	NS	--	--
	Dehalococcoides (DHC)	NS	--	--	NS	--	--	ND	U	0.9	NS	--	--
	Dehalogenimonas spp. (DHG)	NS	--	--	NS	--	--	1110		9.1	NS	--	--
	Desulfitobacterium spp. (DSB)	NS	--	--	NS	--	--	64900		9.1	NS	--	--
	Desulfuromonas spp. (DSM)	NS	--	--	NS	--	--	132		9.1	NS	--	--
	Dichloromethane Dehalogenase (DCMA)	NS	--	--	NS	--	--	ND	U	9.1	NS	--	--
	Epoxyalkane Transferase (EtnE)	NS	--	--	NS	--	--	ND	U	9.1	NS	--	--
	Ethene Monooxygenase (EtnC)	NS	--	--	NS	--	--	85.4		9.1	NS	--	--
	Methanogens (MGN)	NS	--	--	NS	--	--	524		9.1	NS	--	--
	PCE Reductase (PCE-1)	NS	--	--	NS	--	--	ND	U	9.1	NS	--	--
	Phenol Hydroxylase (PHE)	NS	--	--	NS	--	--	8350		9.1	NS	--	--
	PMMO	NS	--	--	NS	--	--	NA	--	--	NS	--	--
	Soluble Methane Monooxygenase (SMMO)	NS	--	--	NS	--	--	608		9.1	NS	--	--
	Sulfate Reducing Bacteria (APS)	NS	--	--	NS	--	--	71300		9.1	NS	--	--
	tceA Reductase (TCE)	NS	--	--	NS	--	--	ND	U	0.9	NS	--	--
	Toluene Dioxygenase (TOD)	NS	--	--	NS	--	--	ND	U	9.1	NS	--	--
	Toluene Monooxygenase (RMO)	NS	--	--	NS	--	--	16500		9.1	NS	--	--
	Toluene Monooxygenase 2 (RDEG)	NS	--	--	NS	--	--	8850		9.1	NS	--	--
Total Eubacteria (EBAC)	NS	--	--	NS	--	--	16100000		9.1	NS	--	--	
trans-1,2-DCE Reductase (TDR)	NS	--	--	NS	--	--	ND	U	9.1	NS	--	--	
Trichlorobenzene Dioxygenase (TCBO)	NS	--	--	NS	--	--	ND	U	9.1	NS	--	--	
Vinyl Chloride Reductase (VCR)	NS	--	--	NS	--	--	ND	U	0.9	NS	--	--	
EDB (µg/L) EPA Method 8011	1,2-DIBROMOETHANE	26.8	J+	1.9	12.6	J	1.9	6.2		0.189	10.6		0.382
VFAs (mg/L) EPA Method 300m	ACETIC ACID	126		10	142.1		10	119		10	122		10
	BUTYRIC ACID	1.8		1	ND	U	1	ND	U	1	ND	U	1
	FORMIC ACID	ND	U	1	1.2		1	0.4	J	1	0.3	J	1
	LACTIC ACID	ND	U	1	ND	U	10	ND	U	1	ND	U	1
	PROPIONIC ACID	36.6		1	27.1		10	24.3		1	24.1		1
	PYRUVIC ACID	0.8	J	1	ND	U	1	0.5	J	1	ND	U	1
	VALERIC ACID	0.6	J	1	ND	U	1	ND	U	1	ND	U	1
Fluorometric (µg/L) Spectrofluorophotometry	FLUORESC EIN	NS	--	--	NS	--	--	NS	--	--	NS	--	--
Reduced Gases (µg/L) RSKSOP-175	ACETYLENE	ND	U	10	ND	U	10	ND	U	10	ND	U	10
	ETHANE	3.1	J	4	4.5		4	4.5		4	4.59		4
	ETHYLENE	11.5		5	12.93		5	11		5	11.7		5
	METHANE	141		2	191		20	601		2	614		2
	PROPANE	2.9	J	6	4.3	J	6	4.8	J	6	4.9	J	6
General Chemistry (mg/L) SM2320b, EPA Method 300, EPA Method 353.2, SM4500 Pe ^c	ALKALINITY	423		1	374		1	421		1	402		1
	BROMIDE	0.53	J	0.625	0.576		0.25	0.597		0.25	0.594		0.25
	CHLORIDE	47.8		1.65	51.1		0.66	51.8		0.66	52		0.66
	IODIDE	18		0.75	17	J-	0.75	22		1.5	22		1.5
	NITRATE	NA	--	--	ND	U	0.2	ND	U	0.2	ND	U	0.2
	NITRITE	NA	--	--	ND	U	0.2	ND	U	0.2	ND	U	0.2
	NITROGEN, NITRATE-NITRITE	ND	U	0.375	NA	--	--	NA	--	--	NA	--	--
	O-PHOSPHATE (AS P)	1.66	J-	0.2	1.07		0.04	1.28		0.04	1.27		0.04
	ORTHOPHOSPHATE	NA	--	--	NA	--	--	NA	--	--	NA	--	--
	PHOSPHORUS	NA	--	--	NA	--	--	NA	--	--	NA	--	--
	SULFATE	ND	U	5	ND	U	2	ND	U	2	ND	U	2

**Table 8
Analytical Data Table for KAFB-106064**

Phase Designation		Phase 2 Passive						Phase 2 Passive					
Sample ID		106064-P2P-030718			106064-P2P-041018			106064-P2P-050918			106064-P2P-050918-FD		
Sample Date		3/7/2018			4/10/2018			5/9/2018			5/9/2018		
Sample Purpose		REG			REG			REG			FD		
Chemical Class and Analytical Method ^a	Parameter	Result	Val Qual	LOQ	Result	Val Qual	LOQ	Result	Val Qual	LOQ	Result	Val Qual	LOQ
Metals (mg/L) EPA Method 6010	LEAD	NS	--	--	NS	--	--	NS	--	--	NS	--	--
Dissolved Metals (mg/L) EPA Method 6010	IRON	3.68		0.06	4.43	J-	0.06	5.07		0.06	4.81		0.06
	MANGANESE	4.47		0.006	5.4	J+	0.006	5.62		0.006	5.41		0.006
δ2H (‰) Mass Spectrometry, USGS Reston, VA	DELTA2H	NS	--	--	NS	--	--	NS	--	--	NS	--	--
CSIA EDB δ13C (‰) Kuder et al, 2012	EDB δ	NS	--	--	NS	--	--	-1.2 ±1.5‰	--	--	NS	--	--
VOCs (µg/L) EPA Method 8260	1,1,2-TRICHLOROETHANE	ND	U	100	ND	U	50	ND	U	100	ND	U	100
	1,2,4-TRICHLOROBENZENE	NA	--	--	NA	--	--	NA	--	--	NA	--	--
	1,2,4-TRIMETHYLBENZENE	354		100	446		50	404		100	409		100
	1,2-DIBROMOETHANE	ND	U	100	ND	U	50	ND	U	100	ND	U	100
	1,2-DICHLOROETHANE	ND	U	100	ND	U	50	ND	U	100	ND	U	100
	1,3,5-TRIMETHYLBENZENE	118	J	100	152		50	124	J	100	142	J	100
	2-BUTANONE	ND	U	1000	ND	U	500	ND	U	1000	ND	U	1000
	2-CHLOROTOLUENE	ND	U	100	ND	U	50	ND	U	100	ND	U	100
	2-HEXANONE	ND	U	500	ND	U	250	ND	U	500	ND	U	500
	4-METHYL-2-PENTANONE	ND	U	500	ND	U	250	ND	U	500	ND	U	500
	ACETONE	ND	U	1000	435	J	500	ND	U	1000	ND	U	1000
	BENZENE	4010		100	3380		50	3490		100	3620		100
	CARBON DISULFIDE	ND	U	100	ND	U	50	ND	U	100	ND	U	100
	CHLOROMETHANE	ND	U	100	ND	U	50	ND	U	100	ND	U	100
	CIS-1,2-DICHLOROETHENE	NA	--	--	NA	--	--	NA	--	--	NA	--	--
	DICHLORODIFLUOROMETHANE	ND	U	200	ND	U	100	ND	U	200	ND	U	200
	ETHYLBENZENE	1810		100	1960		50	1660		100	1670		100
	ISOPROPYLBENZENE	193	J	100	248		50	202		100	207		100
	M,P-XYLENES	NA	--	--	NA	--	--	NA	--	--	NA	--	--
	METHYL TERT-BUTYL ETHER	ND	U	100	ND	U	50	ND	U	100	ND	U	100
	METHYLENE CHLORIDE	ND	U	200	ND	U	100	ND	U	200	ND	U	200
	NAPHTHALENE	93.6	J	100	143		50	137	J	100	137	J	100
	N-BUTYLBENZENE	ND	U	100	ND	U	50	ND	U	100	ND	U	100
	N-PROPYLBENZENE	95.8	J	100	140		50	124	J	100	117	J	100
	O-XYLENE	NA	--	--	NA	--	--	NA	--	--	NA	--	--
	P-ISOPROPYLTOLUENE	ND	U	100	50.8	J	50	56.1	J	100	56.2	J	100
	SEC-BUTYLBENZENE	ND	U	100	ND	U	50	ND	U	100	ND	U	100
	TERT-BUTYLBENZENE	ND	U	100	ND	U	50	ND	U	100	ND	U	100
	TETRACHLOROETHENE	NA	--	--	NA	--	--	NA	--	--	NA	--	--
	TOLUENE	15500		100	12100		50	13900		100	14000		100
	TRANS-1,2-DICHLOROETHENE	NA	--	--	NA	--	--	NA	--	--	NA	--	--
	TRICHLOROETHENE	ND	U	100	ND	U	50	ND	U	100	ND	U	100
	TRICHLOROFUOROMETHANE	ND	U	200	ND	U	100	ND	U	200	ND	U	200
	VINYL CHLORIDE	NA	--	--	NA	--	--	NA	--	--	NA	--	--
	XYLENES	5320		300	5290		150	5130		300	5220		300

Refer to notes at the end of the table.

Table 8
Analytical Data Table for KAFB-106064

Phase Designation		Phase 2 Passive						Phase 3 Recirculation					
Sample ID		106064-P2P-061418			106064-P2P-061418-FD			106064-P3R-080818			106064-P3R-081618		
Sample Date		6/14/2018			6/14/2018			8/8/2018			8/16/2018		
Sample Purpose		REG			FD			REG			REG		
Chemical Class and Analytical Method ^a	Parameter	Result	Val Qual	LOQ	Result	Val Qual	LOQ	Result	Val Qual	LOQ	Result	Val Qual	LOQ
Microbial Community (cells/mL) QuantArray-Chlor	1,1 DCA Reductase (DCA)	NS	--	--	NS	--	--	NS	--	--	NS	--	--
	1,2 DCA Reductase (DCAR)	NS	--	--	NS	--	--	NS	--	--	NS	--	--
	BAV1 Vinyl Chloride Reductase (BVC)	NS	--	--	NS	--	--	NS	--	--	NS	--	--
	cer A Reductase	NS	--	--	NS	--	--	NS	--	--	NS	--	--
	Chloroform Reductase (CFR)	NS	--	--	NS	--	--	NS	--	--	NS	--	--
	Dehalobacter DCM (DCM)	NS	--	--	NS	--	--	NS	--	--	NS	--	--
	Dehalobacter spp. (DHBt)	NS	--	--	NS	--	--	NS	--	--	NS	--	--
	Dehalobium chlorocoercia (DECO)	NS	--	--	NS	--	--	NS	--	--	NS	--	--
	Dehalococcoides (DHC)	NS	--	--	NS	--	--	NS	--	--	NS	--	--
	Dehalogenimonas spp. (DHG)	NS	--	--	NS	--	--	NS	--	--	NS	--	--
	Desulfitobacterium spp. (DSB)	NS	--	--	NS	--	--	NS	--	--	NS	--	--
	Desulfuromonas spp. (DSM)	NS	--	--	NS	--	--	NS	--	--	NS	--	--
	Dichloromethane Dehalogenase (DCMA)	NS	--	--	NS	--	--	NS	--	--	NS	--	--
	Epoxyalkane Transferase (EtnE)	NS	--	--	NS	--	--	NS	--	--	NS	--	--
	Ethene Monooxygenase (EtnC)	NS	--	--	NS	--	--	NS	--	--	NS	--	--
	Methanogens (MGN)	NS	--	--	NS	--	--	NS	--	--	NS	--	--
	PCE Reductase (PCE-1)	NS	--	--	NS	--	--	NS	--	--	NS	--	--
	Phenol Hydroxylase (PHE)	NS	--	--	NS	--	--	NS	--	--	NS	--	--
	PMMO	NS	--	--	NS	--	--	NS	--	--	NS	--	--
	Soluble Methane Monooxygenase (SMMO)	NS	--	--	NS	--	--	NS	--	--	NS	--	--
	Sulfate Reducing Bacteria (APS)	NS	--	--	NS	--	--	NS	--	--	NS	--	--
	tceA Reductase (TCE)	NS	--	--	NS	--	--	NS	--	--	NS	--	--
	Toluene Dioxygenase (TOD)	NS	--	--	NS	--	--	NS	--	--	NS	--	--
	Toluene Monooxygenase (RMO)	NS	--	--	NS	--	--	NS	--	--	NS	--	--
Toluene Monooxygenase 2 (RDEG)	NS	--	--	NS	--	--	NS	--	--	NS	--	--	
Total Eubacteria (EBAC)	NS	--	--	NS	--	--	NS	--	--	NS	--	--	
trans-1,2-DCE Reductase (TDR)	NS	--	--	NS	--	--	NS	--	--	NS	--	--	
Trichlorobenzene Dioxygenase (TCBO)	NS	--	--	NS	--	--	NS	--	--	NS	--	--	
Vinyl Chloride Reductase (VCR)	NS	--	--	NS	--	--	NS	--	--	NS	--	--	
EDB (µg/L) EPA Method 8011	1,2-DIBROMOETHANE	6.19		0.384	6.45		0.384	8.1		0.03	5.5		0.03
VFAs (mg/L) EPA Method 300m	ACETIC ACID	141	J	10	121	J	10	136.4		10	126		10
	BUTYRIC ACID	ND	UJ	10	ND	UJ	10	ND	U	1	ND	U	1
	FORMIC ACID	ND	UJ	10	ND	UJ	10	5.9	J	10	0.7	J	10
	LACTIC ACID	ND	UJ	10	ND	UJ	10	ND	U	1	ND	U	1
	PROPIONIC ACID	11.6	J	10	8.9	J	10	22.2		10	52.9		10
	PYRUVIC ACID	ND	UJ	10	ND	UJ	10	ND	U	1	ND	U	1
	VALERIC ACID	ND	UJ	10	ND	UJ	10	ND	U	1	ND	U	1
Fluorometric (µg/L) Spectrofluorophotometry	FLUORESCIEIN	NS	--	--	NS	--	--	NS	--	--	NS	--	--
Reduced Gases (µg/L) RSKSOP-175	ACETYLENE	ND	UJ	10	ND	UJ	10	ND	U	10	ND	U	10
	ETHANE	5.3	J	4	5.3	J	4	4.4		4	5.1		4
	ETHYLENE	12.6	J	5	13.2	J	5	12.6		5	15.8		5
	METHANE	250	J	2	266	J	2	731.3		2	3096.4		2
	PROPANE	6	J	6	6.5	J	6	5.8	J	6	5.7	J	6
General Chemistry (mg/L) SM2320b, EPA Method 300, EPA Method 353.2, SM4500 Pe ^c	ALKALINITY	483	J-	1	473	J-	1	390		5	390		5
	BROMIDE	0.416	J	0.625	0.417	J	0.625	1.8		1	1.1		0.5
	CHLORIDE	49.3		1.65	49.4		1.65	61		1	54		0.5
	IODIDE	19		1.5	20		1.5	3.7		0.75	4.7		0.75
	NITRATE	ND	U	0.5	ND	U	0.5	NA	--	--	NA	--	--
	NITRITE	ND	U	0.5	ND	U	0.5	NA	--	--	NA	--	--
	NITROGEN, NITRATE-NITRITE	NA	--	--	NA	--	--	ND	R	0.05	ND	U	0.05
	O-PHOSPHATE (AS P)	1.45		0.04	6.73		0.2	NS	--	--	NA	--	--
	ORTHOPHOSPHATE	NA	--	--	NA	--	--	0.39	J-	0.15	2.5		0.15
	PHOSPHORUS	NA	--	--	NA	--	--	NA	--	--	NA	--	--
	SULFATE	ND	U	5	ND	U	5	2.2		2	ND	U	1

Table 8
Analytical Data Table for KAFB-106064

Phase Designation		Phase 2 Passive						Phase 3 Recirculation					
Sample ID		106064-P2P-061418			106064-P2P-061418-FD			106064-P3R-080818			106064-P3R-081618		
Sample Date		6/14/2018			6/14/2018			8/8/2018			8/16/2018		
Sample Purpose		REG			FD			REG			REG		
Chemical Class and Analytical Method ^a	Parameter	Result	Val Qual	LOQ	Result	Val Qual	LOQ	Result	Val Qual	LOQ	Result	Val Qual	LOQ
Metals (mg/L) EPA Method 6010	LEAD	NS	--	--	NS	--	--	NS	--	--	NS	--	--
Dissolved Metals (mg/L) EPA Method 6010	IRON	4.23		0.06	4.11		0.06	3.1		0.05	2.9		0.05
	MANGANESE	5.85		0.006	5.47		0.006	5.8		0.003	6		0.003
δ2H (‰) Mass Spectrometry, USGS Reston, VA	DELTA2H	NS	--	--	NS	--	--	NS	--	--	NS	--	--
CSIA EDB δ13C (‰) Kuder et al, 2012	EDB δ	NS	--	--	NS	--	--	NS	--	--	NS	--	--
VOCs (µg/L) EPA Method 8260	1,1,2-TRICHLOROETHANE	ND	U	100	ND	U	100	ND	U	0.5	ND	U	0.5
	1,2,4-TRICHLOROBENZENE	NA	--	--	NA	--	--	NA	--	--	NA	--	--
	1,2,4-TRIMETHYLBENZENE	367		100	352		100	350		20	370		100
	1,2-DIBROMOETHANE	ND	U	100	ND	U	100	8.5	J+	1	ND	U	1
	1,2-DICHLOROETHANE	ND	U	100	ND	U	100	ND	U	1	ND	U	1
	1,3,5-TRIMETHYLBENZENE	122	J	100	123	J	100	110	J+	0.5	110		0.5
	2-BUTANONE	ND	U	1000	ND	U	1000	50	J+	10	63		10
	2-CHLOROTOLUENE	ND	U	100	ND	U	100	ND	U	0.5	ND	U	0.5
	2-HEXANONE	ND	U	500	ND	U	500	69	J+	5	80		5
	4-METHYL-2-PENTANONE	ND	U	500	ND	U	500	69	J+	5	63		5
	ACETONE	657	J	1000	657	J	1000	160	J+	10	200		10
	BENZENE	3820		100	3820		100	3700		20	3700		100
	CARBON DISULFIDE	ND	U	100	ND	U	100	ND	U	2	ND	U	2
	CHLOROMETHANE	ND	U	100	ND	U	100	ND	U	1	ND	U	1
	CIS-1,2-DICHLOROETHENE	NA	--	--	NA	--	--	NA	--	--	NA	--	--
	DICHLORODIFLUOROMETHANE	ND	U	200	ND	U	200	ND	U	1	ND	U	1
	ETHYLBENZENE	1370		100	1390		100	1100		20	1100		100
	ISOPROPYLBENZENE	149	J	100	158	J	100	110	J+	1	98		1
	M,P-XYLENES	NA	--	--	NA	--	--	NA	--	--	NA	--	--
	METHYL TERT-BUTYL ETHER	ND	U	100	ND	U	100	ND	U	0.5	ND	U	0.5
	METHYLENE CHLORIDE	ND	U	200	ND	U	200	ND	U	5	ND	U	5
	NAPHTHALENE	110	J	100	113	J	100	130	J+	5	130		5
	N-BUTYLBENZENE	ND	U	100	ND	U	100	18	J+	1	18		1
	N-PROPYLBENZENE	104	J	100	112	J	100	85	J+	1	86		1
	O-XYLENE	NA	--	--	NA	--	--	NA	--	--	NA	--	--
	P-ISOPROPYLTOLUENE	ND	U	100	56.6	J	100	85	J+	1	83		1
	SEC-BUTYLBENZENE	ND	U	100	ND	U	100	16	J+	1	16		1
	TERT-BUTYLBENZENE	ND	U	100	ND	U	100	1.3	J+	1	1.2		1
	TETRACHLOROETHENE	NA	--	--	NA	--	--	NA	--	--	NA	--	--
	TOLUENE	13000		100	12900		100	9400	J-	100	9700		100
	TRANS-1,2-DICHLOROETHENE	NA	--	--	NA	--	--	NA	--	--	NA	--	--
	TRICHLOROETHENE	ND	U	100	ND	U	100	ND	U	1	ND	U	1
	TRICHLOROFUOROMETHANE	ND	U	200	ND	U	200	ND	U	1	ND	U	1
	VINYL CHLORIDE	NA	--	--	NA	--	--	NA	--	--	NA	--	--
	XYLENES	4450		300	4410		300	3400		10	3400		50

Refer to notes at the end of the table.

Table 8
Analytical Data Table for KAFB-106064

Phase Designation		Phase 3 Recirculation						Phase 3 Passive					
Sample ID		106064-P3R-082218			106064-P3R-082918			106064-P3P-091218			106064-P3P-091218-FD		
Sample Date		8/22/2018			8/29/2018			9/12/2018			9/12/2018		
Sample Purpose		REG			REG			REG			FD		
Chemical Class and Analytical Method ^a	Parameter	Result	Val Qual	LOQ	Result	Val Qual	LOQ	Result	Val Qual	LOQ	Result	Val Qual	LOQ
Microbial Community (cells/mL) QuantArray-Chlor	1,1 DCA Reductase (DCA)	ND	U	5	NS	--	--	NS	--	--	NS	--	--
	1,2 DCA Reductase (DCAR)	ND	U	5	NS	--	--	NS	--	--	NS	--	--
	BAV1 Vinyl Chloride Reductase (BVC)	ND	U	0.5	NS	--	--	NS	--	--	NS	--	--
	cer A Reductase	ND	U	5	NS	--	--	NS	--	--	NS	--	--
	Chloroform Reductase (CFR)	ND	U	5	NS	--	--	NS	--	--	NS	--	--
	Dehalobacter DCM (DCM)	17400		5	NS	--	--	NS	--	--	NS	--	--
	Dehalobacter spp. (DHBt)	15100		5	NS	--	--	NS	--	--	NS	--	--
	Dehalobium chlorocoercia (DECO)	52000		5	NS	--	--	NS	--	--	NS	--	--
	Dehalococcoides (DHC)	0.3	J	0.5	NS	--	--	NS	--	--	NS	--	--
	Dehalogenimonas spp. (DHG)	ND	U	5	NS	--	--	NS	--	--	NS	--	--
	Desulfitobacterium spp. (DSB)	105000		5	NS	--	--	NS	--	--	NS	--	--
	Desulfuromonas spp. (DSM)	ND	U	5	NS	--	--	NS	--	--	NS	--	--
	Dichloromethane Dehalogenase (DCMA)	ND	U	5	NS	--	--	NS	--	--	NS	--	--
	Epoxyalkane Transferase (EtnE)	124		5	NS	--	--	NS	--	--	NS	--	--
	Ethene Monooxygenase (EtnC)	ND	U	5	NS	--	--	NS	--	--	NS	--	--
	Methanogens (MGN)	10400		5	NS	--	--	NS	--	--	NS	--	--
	PCE Reductase (PCE-1)	ND	U	5	NS	--	--	NS	--	--	NS	--	--
	Phenol Hydroxylase (PHE)	18900		5	NS	--	--	NS	--	--	NS	--	--
	PMMO	NA	--	--	NS	--	--	NS	--	--	NS	--	--
	Soluble Methane Monooxygenase (SMMO)	ND	U	5	NS	--	--	NS	--	--	NS	--	--
	Sulfate Reducing Bacteria (APS)	825000		5	NS	--	--	NS	--	--	NS	--	--
	tceA Reductase (TCE)	ND	U	0.5	NS	--	--	NS	--	--	NS	--	--
	Toluene Dioxygenase (TOD)	ND	U	5	NS	--	--	NS	--	--	NS	--	--
	Toluene Monooxygenase (RMO)	44400		5	NS	--	--	NS	--	--	NS	--	--
Toluene Monooxygenase 2 (RDEG)	11900		5	NS	--	--	NS	--	--	NS	--	--	
Total Eubacteria (EBAC)	29600000		5	NS	--	--	NS	--	--	NS	--	--	
trans-1,2-DCE Reductase (TDR)	ND	U	5	NS	--	--	NS	--	--	NS	--	--	
Trichlorobenzene Dioxygenase (TCBO)	ND	U	5	NS	--	--	NS	--	--	NS	--	--	
Vinyl Chloride Reductase (VCR)	ND	U	0.5	NS	--	--	NS	--	--	NS	--	--	
EDB (µg/L) EPA Method 8011	1,2-DIBROMOETHANE	2.5		0.0003	3		0.015	1.5		0.0058	1.7		0.015
VFAs (mg/L) EPA Method 300m	ACETIC ACID	119.3		10	94.8		10	50.6		10	50.1		10
	BUTYRIC ACID	ND	U	1	ND	U	1	ND	U	1	ND		1
	FORMIC ACID	0.7	J	10	1.4		1	ND	U	1	ND		1
	LACTIC ACID	ND	U	1	ND	U	1	ND	U	1	ND		1
	PROPIONIC ACID	66.7		10	66.9		10	74.9		10	76.1		10
	PYRUVIC ACID	ND	U	1	ND	U	1	ND	U	1	ND		1
	VALERIC ACID	ND	U	1	ND	U	1	ND	U	1	ND		1
Fluorometric (µg/L) Spectrofluorophotometry	FLUORESC EIN	NS	--	--	NS	--	--	NS	--	--	NS	--	--
Reduced Gases (µg/L) RSKSOP-175	ACETYLENE	ND	U	10	ND	U	10	ND	U	10	ND		10
	ETHANE	4.8		4	2.5	J	4	4.2		4	4.2		4
	ETHYLENE	13.2		5	7.7		5	10.4		5	10.4		5
	METHANE	3897.9		2	2501.3		2	7053.1		2	7090.1		2
	PROPANE	5.9	J	6	3.2	J	6	5.7	J	6	5.7		6
General Chemistry (mg/L) SM2320b, EPA Method 300, EPA Method 353.2, SM4500 Pe ^c	ALKALINITY	420		5	420		5	450		5	460		5
	BROMIDE	2		0.5	0.85		0.5	0.78	J+	0.5	0.77		0.5
	CHLORIDE	52		0.5	54		0.5	51		0.5	51		0.5
	IODIDE	3.1		0.75	5		0.75	4.5		0.75	5.3		0.75
	NITRATE	NA	--	--	NA	--	--	NA	--	--	NA	--	--
	NITRITE	NA	--	--	NA	--	--	NA	--	--	NA	--	--
	NITROGEN, NITRATE-NITRITE	ND		0.05	ND	U	0.05	ND	UJ	0.05	ND	U	0.05
	O-PHOSPHATE (AS P)	NA	--	--	NA	--	--	NA	--	--	NA	--	--
	ORTHOPHOSPHATE	3.5		0.15	4.3		0.15	3.9		0.15	3.9		0.15
	PHOSPHORUS	NA	--	--	NA	--	--	NA	--	--	NA	--	--
	SULFATE	ND		1	ND	U	1	ND	U	1	ND	U	1

Table 8
Analytical Data Table for KAFB-106064

Phase Designation		Phase 3 Recirculation						Phase 3 Passive					
Sample ID		106064-P3R-082218			106064-P3R-082918			106064-P3P-091218			106064-P3P-091218-FD		
Sample Date		8/22/2018			8/29/2018			9/12/2018			9/12/2018		
Sample Purpose		REG			REG			REG			FD		
Chemical Class and Analytical Method ^a	Parameter	Result	Val Qual	LOQ	Result	Val Qual	LOQ	Result	Val Qual	LOQ	Result	Val Qual	LOQ
Metals (mg/L) EPA Method 6010	LEAD	NS	--	--	NS	--	--	NS	--	--	NS	--	--
Dissolved Metals (mg/L) EPA Method 6010	IRON	3.4		0.05	2.6		0.05	3		0.05	3		0.05
	MANGANESE	7.2		0.003	6		0.003	6.5		0.003	6.6		0.003
δ2H (‰) Mass Spectrometry, USGS Reston, VA	DELTA2H	NS	--	--	NS	--	--	NS	--	--	NS	--	--
CSIA EDB δ13C (‰) Kuder et al, 2012	EDB δ	-10.2 ±1.5‰	--	--	NS	--	--	-4.5 ±5‰	--	--	NS	--	--
VOCs (µg/L) EPA Method 8260	1,1,2-TRICHLOROETHANE	ND	U	50	ND	U	0.5	ND	U	50	ND	U	50
	1,2,4-TRICHLOROBENZENE	NA	--	--	NA	--	--	NA	--	--	NA	--	--
	1,2,4-TRIMETHYLBENZENE	360	J+	100	320		100	350		100	360		100
	1,2-DIBROMOETHANE	ND	U	100	4.7	J+	1	ND	U	100	ND	U	100
	1,2-DICHLOROETHANE	ND	U	100	3.2		1	ND	U	100	ND	U	100
	1,3,5-TRIMETHYLBENZENE	110	J+	50	110	J+	0.5	120		50	120		50
	2-BUTANONE	ND	U	1000	74	J+	10	ND	U	1000	ND	U	1000
	2-CHLOROTOLUENE	ND	U	50	ND	U	0.5	ND	U	50	ND	U	50
	2-HEXANONE	ND	U	500	78	J+	5	ND	U	500	ND	U	500
	4-METHYL-2-PENTANONE	ND	U	500	66	J+	5	ND	U	500	ND	U	500
	ACETONE	ND	U	1000	280	J+	10	ND	U	1000	ND	U	1000
	BENZENE	4000	J+	100	3500		100	3300		100	3400		100
	CARBON DISULFIDE	ND	U	200	ND	U	2	ND	U	200	ND	U	200
	CHLOROMETHANE	ND	U	100	ND	U	1	ND	U	100	ND	U	100
	CIS-1,2-DICHLOROETHENE	NA	--	--	NA	--	--	NA	--	--	NA	--	--
	DICHLORODIFLUOROMETHANE	ND	U	100	ND	U	1	ND	U	100	ND	U	100
	ETHYLBENZENE	1000		100	1000		100	1100		100	1200		100
	ISOPROPYLBENZENE	110	J+	100	94	J+	1	100		100	100		100
	M,P-XYLENES	NA	--	--	NA	--	--	NA	--	--	NA	--	--
	METHYL TERT-BUTYL ETHER	ND	U	50	ND	U	0.5	ND	U	50	ND	U	50
	METHYLENE CHLORIDE	ND	U	500	ND	U	5	ND	U	500	ND	U	500
	NAPHTHALENE	ND	U	500	130	J+	5	ND	U	500	ND	U	500
	N-BUTYLBENZENE	ND	U	100	19	J+	1	ND	U	100	ND	U	100
	N-PROPYLBENZENE	88	J+	100	87	J+	1	94	J	100	92	J	100
	O-XYLENE	NA	--	--	NA	--	--	NA	--	--	NA	--	--
	P-ISOPROPYLTOLUENE	86	J+	100	77	J+	1	64	J	100	62	J	100
	SEC-BUTYLBENZENE	ND	U	100	16	J+	1	ND	U	100	ND	U	100
	TERT-BUTYLBENZENE	ND	U	100	ND	U	1	ND	U	100	ND	U	100
	TETRACHLOROETHENE	NA	--	--	NA	--	--	NA	--	--	NA	--	--
	TOLUENE	12000	J+	100	10000		100	11000		100	11000		100
	TRANS-1,2-DICHLOROETHENE	NA	--	--	NA	--	--	NA	--	--	NA	--	--
	TRICHLOROETHENE	ND	U	100	ND	U	1	ND	U	100	ND	U	100
	TRICHLOROFLUOROMETHANE	ND	U	100	ND	U	1	ND	U	100	ND	U	100
	VINYL CHLORIDE	NA	--	--	NA	--	--	NA	--	--	NA	--	--
	XYLENES	3400	J+	50	3300		50	3500		50	3700		50

Refer to notes at the end of the table.

Table 8
Analytical Data Table for KAFB-106064

Phase Designation		Phase 3 Passive						Phase 4 Passive					
Sample ID		106064-P3P-100418			106064-P3P-111418			106064-P4P-011619			106064-P4P-011619-FD		
Sample Date		10/4/2018			11/14/2018			1/16/2019			1/16/2019		
Sample Purpose		REG			REG			REG			FD		
Chemical Class and Analytical Method ^a	Parameter	Result	Val Qual	LOQ	Result	Val Qual	LOQ	Result	Val Qual	LOQ	Result	Val Qual	LOQ
Microbial Community (cells/mL) QuantArray-Chlor	1,1 DCA Reductase (DCA)	NS	--	--	ND	U	5	NS	--	--	ND	U	5.2
	1,2 DCA Reductase (DCAR)	NS	--	--	ND	U	5	NS	--	--	ND	U	5.2
	BAV1 Vinyl Chloride Reductase (BVC)	NS	--	--	ND	U	0.5	NS	--	--	ND	U	0.5
	cer A Reductase	NS	--	--	121		5	NS	--	--	ND	U	5.2
	Chloroform Reductase (CFR)	NS	--	--	ND	U	5	NS	--	--	ND	U	5.2
	Dehalobacter DCM (DCM)	NS	--	--	2700		5	NS	--	--	8140		5.2
	Dehalobacter spp. (DHBt)	NS	--	--	169000		5	NS	--	--	1350000		5.2
	Dehalobium chlorocoercia (DECO)	NS	--	--	4820		5	NS	--	--	22300		5.2
	Dehalococcoides (DHC)	NS	--	--	ND	U	0.5	NS	--	--	0.2	J	0.5
	Dehalogenimonas spp. (DHG)	NS	--	--	ND	U	5	NS	--	--	ND	U	5.2
	Desulfitobacterium spp. (DSB)	NS	--	--	99400		5	NS	--	--	450000		5.2
	Desulfuromonas spp. (DSM)	NS	--	--	36.6		5	NS	--	--	19.6		5.2
	Dichloromethane Dehalogenase (DCMA)	NS	--	--	ND	U	5	NS	--	--	ND	U	5.2
	Epoxyalkane Transferase (EtnE)	NS	--	--	ND	U	5	NS	--	--	94.8		5.2
	Ethene Monooxygenase (EtnC)	NS	--	--	ND	U	5	NS	--	--	ND	U	5.2
	Methanogens (MGN)	NS	--	--	68700		5	NS	--	--	127000		5.2
	PCE Reductase (PCE-1)	NS	--	--	ND	U	5	NS	--	--	ND	U	5.2
	Phenol Hydroxylase (PHE)	NS	--	--	13300		5	NS	--	--	15700		5.2
	PMMO	NS	--	--	NA	--	--	NS	--	--	NA	--	--
	Soluble Methane Monooxygenase (SMMO)	NS	--	--	1080		5	NS	--	--	ND	U	5.2
	Sulfate Reducing Bacteria (APS)	NS	--	--	44700		5	NS	--	--	72700		5.2
	tceA Reductase (TCE)	NS	--	--	ND	U	0.5	NS	--	--	ND	U	0.5
	Toluene Dioxygenase (TOD)	NS	--	--	ND	U	5	NS	--	--	ND	U	5.2
	Toluene Monooxygenase (RMO)	NS	--	--	6670		5	NS	--	--	18800		5.2
	Toluene Monooxygenase 2 (RDEG)	NS	--	--	5350		5	NS	--	--	11100		5.2
Total Eubacteria (EBAC)	NS	--	--	6160000		5	NS	--	--	13100000		5.2	
trans-1,2-DCE Reductase (TDR)	NS	--	--	ND	U	5	NS	--	--	ND	U	5.2	
Trichlorobenzene Dioxygenase (TCBO)	NS	--	--	ND	U	5	NS	--	--	ND	U	5.2	
Vinyl Chloride Reductase (VCR)	NS	--	--	ND	U	0.5	NS	--	--	ND	U	0.5	
EDB (µg/L) EPA Method 8011	1,2-DIBROMOETHANE	0.32	J+	0.0015	0.025	J	0.00029	0.028		0.0003	0.026		0.0003
VFAs (mg/L) EPA Method 300m	ACETIC ACID	29.5		10	ND	U	1	0.5	J	1	0.3	J	1
	BUTYRIC ACID	ND	U	1	ND	U	1	ND	U	1	ND	U	1
	FORMIC ACID	ND	U	1	ND	U	1	ND	U	1	ND	U	1
	LACTIC ACID	0.4	J	1	0.9	J	1	0.8	J	1	0.8	J	1
	PROPIONIC ACID	16.6		10	ND	U	1	ND	U	1	ND	U	1
	PYRUVIC ACID	ND	U	1	ND	U	1	ND	U	1	ND	U	1
	VALERIC ACID	ND	U	1	ND	U	1	ND	U	1	ND	U	1
Fluorometric (µg/L) Spectrofluorophotometry	FLUORESCIEIN	NS	--	--	NS	--	--	NS	--	--	NS	--	--
Reduced Gases (µg/L) RSKSOP-175	ACETYLENE	ND	U	10	ND	U	10	ND	U	10	ND	U	10
	ETHANE	3.9	J	4	4.3		4	4.5		4	4.5		4
	ETHYLENE	8.4		5	8.3		5	6.7		5	6.6		5
	METHANE	11125.4		2	14886.8		2	14220.9		20	15034.6		20
	PROPANE	5.1	J	6	5.1	J	6	5.5	J	6	5.3	J	6
General Chemistry (mg/L) SM2320b, EPA Method 300, EPA Method 353.2, SM4500 Pe ^c	ALKALINITY	480		5	510		5	510		5	510		5
	BROMIDE	1.4		0.5	1.3		0.5	1.1		0.5	0.77		0.5
	CHLORIDE	48		0.5	48		0.5	47		0.5	48		0.5
	IODIDE	4.2		0.75	4.2	J+	0.75	4		0.75	NA	--	--
	NITRATE	NA	--	--	NA	--	--	NA	--	--	NA	--	--
	NITRITE	NA	--	--	NA	--	--	NA	--	--	NA	--	--
	NITROGEN, NITRATE-NITRITE	ND	U	0.05	ND	U	0.05	ND	UJ	0.05	ND	UJ	0.05
	O-PHOSPHATE (AS P)	NA	--	--	NA	--	--	NA	--	--	NA	--	--
	ORTHOPHOSPHATE	2.9		0.15	0.92	J	0.75	0.14	J	0.15	0.12	J	0.15
	PHOSPHORUS	NA	--	--	NA	--	--	NA	--	--	NA	--	--
	SULFATE	ND	U	1	ND	U	1	ND	U	1	ND	U	1

Table 8
Analytical Data Table for KAFB-106064

Phase Designation		Phase 3 Passive						Phase 4 Passive					
Sample ID		106064-P3P-100418			106064-P3P-111418			106064-P4P-011619			106064-P4P-011619-FD		
Sample Date		10/4/2018			11/14/2018			1/16/2019			1/16/2019		
Sample Purpose		REG			REG			REG			FD		
Chemical Class and Analytical Method ^a	Parameter	Result	Val Qual	LOQ	Result	Val Qual	LOQ	Result	Val Qual	LOQ	Result	Val Qual	LOQ
Metals (mg/L) EPA Method 6010	LEAD	NS	--	--	NS	--	--	NS	--	--	NS	--	--
Dissolved Metals (mg/L) EPA Method 6010	IRON	3.6		0.05	4		0.05	5.1		0.05	5		0.05
	MANGANESE	7.7		0.003	6.8		0.003	7.1		0.003	6.4		0.003
δ2H (‰) Mass Spectrometry, USGS Reston, VA	DELTA2H	NS	--	--	NS	--	--	NS	--	--	NS	--	--
CSIA EDB δ13C (‰) Kuder et al, 2012	EDB δ	NS	--	--	NS	--	--	NS	--	--	NS	--	--
VOCs (µg/L) EPA Method 8260	1,1,2-TRICHLOROETHANE	ND	U	25	ND	U	25	ND	U	50	ND	U	50
	1,2,4-TRICHLOROBENZENE	NA	--	--	NA	--	--	NA	--	--	NA	--	--
	1,2,4-TRIMETHYLBENZENE	350		50	380		50	470		100	420		100
	1,2-DIBROMOETHANE	ND	U	50	ND	U	50	ND	U	100	ND	U	100
	1,2-DICHLOROETHANE	ND	U	50	ND	U	50	NA	--	--	NA	--	--
	1,3,5-TRIMETHYLBENZENE	120		25	140		25	160		50	140		50
	2-BUTANONE	ND	U	500	ND	U	500	ND	U	1000	ND	U	1000
	2-CHLOROTOLUENE	ND	U	25	ND	U	25	ND	U	50	ND	U	50
	2-HEXANONE	ND	U	250	ND	U	250	ND	U	500	ND	U	500
	4-METHYL-2-PENTANONE	ND	U	250	ND	U	250	ND	U	500	ND	U	500
	ACETONE	ND	U	500	ND	U	500	ND	U	1000	ND	U	1000
	BENZENE	3300		50	3200		50	3400		100	3200		100
	CARBON DISULFIDE	ND	U	100	ND	U	100	ND	U	200	ND	U	200
	CHLOROMETHANE	ND	U	50	ND	U	50	ND	U	100	ND	U	100
	CIS-1,2-DICHLOROETHENE	NA	--	--	NA	--	--	NA	--	--	NA	--	--
	DICHLORODIFLUOROMETHANE	ND	U	50	ND	U	50	NA	--	--	NA	--	--
	ETHYLBENZENE	110		50	1800		50	NA	--	--	NA	--	--
	ISOPROPYLBENZENE	100		50	190		50	230		100	210		100
	M,P-XYLENES	NA	--	--	NA	--	--	NA	--	--	NA	--	--
	METHYL TERT-BUTYL ETHER	ND	U	25	ND	U	25	ND	U	50	ND	U	50
	METHYLENE CHLORIDE	ND	U	250	ND	U	250	ND	U	500	ND	U	500
	NAPHTHALENE	140	J	250	140	J	250	ND	U	500	ND	U	500
	N-BUTYLBENZENE	ND	U	50	ND	U	50	ND	U	100	ND	U	100
	N-PROPYLBENZENE	95		50	120		50	160		100	130		100
	O-XYLENE	NA	--	--	NA	--	--	NA	--	--	NA	--	--
	P-ISOPROPYLTOLUENE	68		50	52		50	ND	U	100	ND	U	100
	SEC-BUTYLBENZENE	ND	U	50	ND	U	50	ND	U	100	ND	U	100
	TERT-BUTYLBENZENE	ND	U	50	ND	U	50	ND	U	100	ND	U	100
	TETRACHLOROETHENE	NA	--	--	NA	--	--	NA	--	--	NA	--	--
	TOLUENE	11000		100	11000		100	990		100	930		100
	TRANS-1,2-DICHLOROETHENE	NA	--	--	NA	--	--	NA	--	--	NA	--	--
	TRICHLOROETHENE	ND	U	50	ND	U	50	ND	U	100	ND	U	100
	TRICHLOROFUOROMETHANE	ND	U	50	ND	U	50	ND	U	100	ND	U	100
	VINYL CHLORIDE	NA	--	--	NA	--	--	NA	--	--	NA	--	--
	XYLENES	3600		25	5500		25	5000		50	4500		50

Refer to notes at the end of the table.

Table 8
Analytical Data Table for KAFB-106064

Phase Designation		Phase 4 Passive											
Sample ID		106064-LTM-031120			106064-LTM-031120-FD			106064-LTM-051920			106064-LTM-080420		
Sample Date		3/11/2020			3/11/2020			5/19/2020			8/4/2020		
Sample Purpose		REG			FD			REG			REG		
Chemical Class and Analytical Method ^a	Parameter	Result	Val Qual	LOQ	Result	Val Qual	LOQ	Result	Val Qual	LOQ	Result	Val Qual	LOQ
Microbial Community (cells/mL) QuantArray-Chlor	1,1 DCA Reductase (DCA)	ND	U	4.8	NS	--	--	ND	U	5	ND	U	4.6
	1,2 DCA Reductase (DCAR)	ND	U	4.8	NS	--	--	ND	U	5	ND	U	4.6
	BAV1 Vinyl Chloride Reductase (BVC)	0.5	J	0.5	NS	--	--	ND	U	0.5	ND	U	0.5
	cer A Reductase	ND	U	4.8	NS	--	--	ND	U	5	ND	U	4.6
	Chloroform Reductase (CFR)	ND	U	4.8	NS	--	--	ND	U	5	ND	U	4.6
	Dehalobacter DCM (DCM)	ND	U	4.8	NS	--	--	ND	U	5	ND	U	4.6
	Dehalobacter spp. (DHBt)	145000		4.8	NS	--	--	342000		5	100000		4.6
	Dehalobium chlorocoercia (DECO)	10500		4.8	NS	--	--	3340		5	1310		4.6
	Dehalococcoides (DHC)	27		0.5	NS	--	--	2.1		0.5	1.6		0.5
	Dehalogenimonas spp. (DHG)	ND	U	4.8	NS	--	--	ND	U	5	ND	U	4.6
	Desulfitobacterium spp. (DSB)	38700		4.8	NS	--	--	128000		5	30300		4.6
	Desulfuromonas spp. (DSM)	ND	U	4.8	NS	--	--	ND	U	5	0.3	J	4.6
	Dichloromethane Dehalogenase (DCMA)	ND	U	4.8	NS	--	--	ND	U	5	ND	U	4.6
	Epoxyalkane Transferase (EtnE)	ND	U	4.8	NS	--	--	ND	U	5	ND	U	4.6
	Ethene Monooxygenase (EtnC)	ND	U	4.8	NS	--	--	ND	U	5	ND	U	4.6
	Methanogens (MGN)	59100		4.8	NS	--	--	38600		5	48000		4.6
	PCE Reductase (PCE-1)	ND	U	4.8	NS	--	--	ND	U	5	ND	U	4.6
	Phenol Hydroxylase (PHE)	8890		4.8	NS	--	--	631		5	449		4.6
	PMMO	NA	--	--	NS	--	--	NA	--	--	NA	--	--
	Soluble Methane Monooxygenase (SMMO)	2800		4.8	NS	--	--	24.6		5	776		4.6
	Sulfate Reducing Bacteria (APS)	39800		4.8	NS	--	--	32400		5	28200		4.6
	tceA Reductase (TCE)	1		0.5	NS	--	--	0.6		0.5	ND	U	0.5
	Toluene Dioxygenase (TOD)	ND	U	4.8	NS	--	--	ND	U	5	ND	U	4.6
	Toluene Monooxygenase (RMO)	12800		4.8	NS	--	--	1160		5	ND	U	4.6
Toluene Monooxygenase 2 (RDEG)	12100		4.8	NS	--	--	2020		5	1170		4.6	
Total Eubacteria (EBAC)	14800000		4.8	NS	--	--	22900000		5	6410000		4.6	
trans-1,2-DCE Reductase (TDR)	ND	U	4.8	NS	--	--	ND	U	5	ND	U	4.6	
Trichlorobenzene Dioxygenase (TCBO)	ND	U	4.8	NS	--	--	ND	U	5	ND	U	4.6	
Vinyl Chloride Reductase (VCR)	6.3		0.5	NS	--	--	ND	U	0.5	ND	U	0.5	
EDB (µg/L) EPA Method 8011	1,2-DIBROMOETHANE	ND	U	0.01	ND	U	0.01	ND	U	0.01	ND	U	0.011
VFAs (mg/L) EPA Method 300m	ACETIC ACID	0.5	J	10	ND	U	1	ND	U	10	ND	U	10
	BUTYRIC ACID	ND	U	1	ND	U	1	ND	U	10	ND	U	10
	FORMIC ACID	0.9	J	10	0.5	J	10	0.3	J	10	3.3	J	10
	LACTIC ACID	1.5	J	10	1.4	J	10	ND	U	10	ND	U	10
	PROPIONIC ACID	ND	U	1	ND	U	1	ND	U	10	ND	U	10
	PYRUVIC ACID	ND	U	1	ND	U	1	ND	U	10	ND	U	10
	VALERIC ACID	ND	U	1	ND	U	1	ND	U	10	ND	U	10
Fluorometric (µg/L) Spectrofluorophotometry	FLUORESC EIN	NS	--	--	NS	--	--	NS	--	--	NS	--	--
Reduced Gases (µg/L) RSKSOP-175	ACETYLENE	ND	U	10	ND	U	10	ND	U	10	ND	U	10
	ETHANE	1.5	J	4	1.7	J	4	8.2		4	4.1		4
	ETHYLENE	ND	U	5	ND	U	5	2.8		5	1.7	J	5
	METHANE	2626.3		2	2942.2		2	11127.7		2	8613.5		2
	PROPANE	ND	U	6	ND	U	6	4.5	J	6	2.9	J	6
General Chemistry (mg/L) SM2320b, EPA Method 300, EPA Method 353.2, SM4500 Pe ^c	ALKALINITY	599		5	607		5	673		5	707		5
	BROMIDE	0.832		0.1	0.837		0.1	0.813		0.1	0.921		0.1
	CHLORIDE	49		0.5	48.1		0.5	47.8		0.5	50.8		0.5
	IODIDE	4.1		0.2	3.8		0.2	6.3		0.2	6.1		2
	NITRATE	0.0572	J	0.1	0.0758	J	0.1	0.0718	J-	0.1	0.0842	J	0.1
	NITRITE	NA	--	--	NA	--	--	NA	--	--	NA	--	--
	NITROGEN, NITRATE-NITRITE	ND	U	0.1	ND	U	0.1	ND	UJ	0.1	ND	U	0.1
	O-PHOSPHATE (AS P)	NA	--	--	NA	--	--	NA	--	--	NA	--	--
	ORTHOPHOSPHATE	NA	--	--	NA	--	--	NA	--	--	NA	--	--
	PHOSPHORUS	0.011	J	0.025	0.017	J	0.025	0.029	J-	0.025	0.092		0.025
	SULFATE	ND	U	0.5	ND	U	0.5	0.326	J	0.5	1.07		0.5

Table 8
Analytical Data Table for KAFB-106064

Phase Designation		Phase 4 Passive											
Sample ID		106064-LTM-031120			106064-LTM-031120-FD			106064-LTM-051920			106064-LTM-080420		
Sample Date		3/11/2020			3/11/2020			5/19/2020			8/4/2020		
Sample Purpose		REG			FD			REG			REG		
Chemical Class and Analytical Method ^a	Parameter	Result	Val Qual	LOQ	Result	Val Qual	LOQ	Result	Val Qual	LOQ	Result	Val Qual	LOQ
Metals (mg/L) EPA Method 6010	LEAD	ND	U	0.001	ND	U	0.001	ND	U	0.001	ND	U	0.001
Dissolved Metals (mg/L) EPA Method 6010	IRON	6.59		0.05	6.51		0.05	7.52		0.05	6.39		0.05
	MANGANESE	6.4		0.125	6.17		0.125	7.07		0.125	7.26		0.125
δ2H (‰) Mass Spectrometry, USGS Reston, VA	DELTA2H	NS	--	--	NS	--	--	NS	--	--	NS	--	--
CSIA EDB δ13C (‰) Kuder et al, 2012	EDB δ	NS	--	--	NS	--	--	NS	--	--	NS	--	--
VOCs (µg/L) EPA Method 8260	1,1,2-TRICHLOROETHANE	ND	U	2.5	ND	U	2.5	ND	U	5	ND	U	10
	1,2,4-TRICHLOROBENZENE	ND	U	2.5	ND	U	2.5	ND	U	5	ND	U	10
	1,2,4-TRIMETHYLBENZENE	NA	--	--	NA	--	--	NA	--	--	NA	--	--
	1,2-DIBROMOETHANE	ND	U	2.5	ND	U	2.5	ND	U	2.5	ND	U	5
	1,2-DICHLOROETHANE	ND	U	2.5	ND	U	2.5	ND	U	2.5	ND	U	5
	1,3,5-TRIMETHYLBENZENE	110		2.5	110		2.5	120		5	130		10
	2-BUTANONE	ND	U	5	ND	U	5	ND	U	5	ND	U	10
	2-CHLOROTOLUENE	ND	U	2.5	ND	U	2.5	ND	U	5	ND	U	10
	2-HEXANONE	ND	U	5	ND	U	5	ND	U	10	ND	U	20
	4-METHYL-2-PENTANONE	ND	U	5	ND	U	5	ND	U	10	ND	U	20
	ACETONE	ND	U	5	ND	U	5	ND	U	5	61		10
	BENZENE	2800		25	2900		25	2900		12	3500		50
	CARBON DISULFIDE	ND	U	5	ND	U	5	ND	U	5	ND	U	10
	CHLOROMETHANE	ND	U	2.5	ND	U	2.5	ND	U	2.5	ND	U	5
	CIS-1,2-DICHLOROETHENE	ND	U	2.5	ND	U	2.5	ND	U	2.5	ND	U	5
	DICHLORODIFLUOROMETHANE	ND	U	2.5	ND	U	2.5	ND	U	5	ND	U	10
	ETHYLBENZENE	1300		25	1300		25	1300		25	1200		10
	ISOPROPYLBENZENE	160		2.5	160		2.5	160		5	170		10
	M,P-XYLENES	2600		50	2700		50	2700		25	2400		10
	METHYL TERT-BUTYL ETHER	ND	U	2.5	ND	U	2.5	ND	U	2.5	ND	U	5
	METHYLENE CHLORIDE	ND	U	5	ND	U	5	ND	U	5	ND	U	10
	NAPHTHALENE	89		2.5	100		2.5	120		5	130		10
	N-BUTYLBENZENE	14		2.5	15		2.5	16		5	18		10
	N-PROPYLBENZENE	100		2.5	100		2.5	110		5	110		10
	O-XYLENE	1200		25	1200		25	1200		25	1100		10
	P-ISOPROPYLTOLUENE	ND	U	2.5	ND	U	2.5	30		5	54		10
	SEC-BUTYLBENZENE	15		2.5	17		2.5	17		5	19		10
	TERT-BUTYLBENZENE	ND	U	2.5	ND	U	2.5	ND	U	5	ND	U	10
	TETRACHLOROETHENE	ND	U	2.5	ND	U	2.5	ND	U	5	ND	U	10
	TOLUENE	29		2.5	25		2.5	290		2.5	580		5
	TRANS-1,2-DICHLOROETHENE	ND	U	2.5	ND	U	2.5	ND	U	2.5	ND	U	5
	TRICHLOROETHENE	ND	U	2.5	ND	U	2.5	ND	U	2.5	ND	U	5
	TRICHLOROFLUOROMETHANE	ND	U	2.5	ND	U	2.5	ND	U	5	ND	U	10
	VINYL CHLORIDE	ND	U	2.5	ND	U	2.5	ND	U	2.5	ND	U	5
	XYLENES	3800		25	3900		25	4000		25	3600		10

Refer to notes at the end of the table.

Table 8
Analytical Data Table for KAFB-106064

Phase Designation		Phase 4 Passive		
Sample ID		106064-LTM-101420		
Sample Date		10/14/2020		
Sample Purpose		REG		
Chemical Class and Analytical Method ^a	Parameter	Result	Val Qual	LOQ
Microbial Community (cells/mL) QuantArray-Chlor	1,1 DCA Reductase (DCA)	ND	U	5.1
	1,2 DCA Reductase (DCAR)	ND	U	5.1
	BAV1 Vinyl Chloride Reductase (BVC)	ND	U	0.5
	cer A Reductase	ND	U	5.1
	Chloroform Reductase (CFR)	ND	U	5.1
	Dehalobacter DCM (DCM)	ND	U	5.1
	Dehalobacter spp. (DHBt)	166000		5.1
	Dehalobium chlorocoercia (DECO)	1460		5.1
	Dehalococcoides (DHC)	5.4		0.5
	Dehalogenimonas spp. (DHG)	ND	U	5.1
	Desulfitobacterium spp. (DSB)	51100		5.1
	Desulfuromonas spp. (DSM)	ND	U	5.1
	Dichloromethane Dehalogenase (DCMA)	ND	U	5.1
	Epoxyalkane Transferase (EtnE)	ND	U	5.1
	Ethene Monooxygenase (EtnC)	ND	U	5.1
	Methanogens (MGN)	38400		5.1
	PCE Reductase (PCE-1)	ND	U	5.1
	Phenol Hydroxylase (PHE)	427		5.1
	PMMO	NA	--	--
	Soluble Methane Monooxygenase (SMMO)	66.4		5.1
	Sulfate Reducing Bacteria (APS)	20700		5.1
	tceA Reductase (TCE)	ND	U	0.5
	Toluene Dioxygenase (TOD)	ND	U	5.1
	Toluene Monooxygenase (RMO)	749		5.1
	Toluene Monooxygenase 2 (RDEG)	384		5.1
	Total Eubacteria (EBAC)	11900000		5.1
	trans-1,2-DCE Reductase (TDR)	ND	U	5.1
	Trichlorobenzene Dioxygenase (TCBO)	ND	U	5.1
	Vinyl Chloride Reductase (VCR)	0.1		0.5
	EDB (µg/L) EPA Method 8011	1,2-DIBROMOETHANE	ND	U
VFAs (mg/L) EPA Method 300m	ACETIC ACID	ND	U	10
	BUTYRIC ACID	ND	U	10
	FORMIC ACID	1.2	J	10
	LACTIC ACID	ND	U	10
	PROPIONIC ACID	ND	U	10
	PYRUVIC ACID	ND	U	10
	VALERIC ACID	ND	U	10
Fluorometric (µg/L) Spectrofluorophotometry	FLUORESC EIN	NS	--	--
Reduced Gases (µg/L) RSKSOP-175	ACETYLENE	ND	U	10
	ETHANE	3.2		4
	ETHYLENE	5		5
	METHANE	5693.7		2
	PROPANE	2.3		6
General Chemistry (mg/L) SM2320b, EPA Method 300, EPA Method 353.2, SM4500 Pe ^c	ALKALINITY	637		5
	BROMIDE	0.77		0.1
	CHLORIDE	47.3		0.5
	IODIDE	4.1		
	NITRATE	0.047	J	0.1
	NITRITE	NA	--	--
	NITROGEN, NITRATE-NITRITE	ND	U	0.1
	O-PHOSPHATE (AS P)	NA	--	--
	ORTHOPHOSPHATE	NA	--	--
	PHOSPHORUS	0.073		0.025
	SULFATE	0.258	J	0.5

Table 8
Analytical Data Table for KAFB-106064

Phase Designation		Phase 4 Passive		
Sample ID		106064-LTM-101420		
Sample Date		10/14/2020		
Sample Purpose		REG		
Chemical Class and Analytical Method ^a	Parameter	Result	Val Qual	LOQ
Metals (mg/L) EPA Method 6010	LEAD	ND	U	0.001
Dissolved Metals (mg/L) EPA Method 6010	IRON	5.6		0.05
	MANGANESE	6.77		0.125
δ2H (‰) Mass Spectrometry, USGS Reston, VA	DELTA2H	NS	--	--
CSIA EDB δ13C (‰) Kuder et al, 2012	EDB δ	NS	--	--
VOCs (µg/L) EPA Method 8260	1,1,2-TRICHLOROETHANE	ND	U	10
	1,2,4-TRICHLOROBENZENE	ND	U	10
	1,2,4-TRIMETHYLBENZENE	NA	--	--
	1,2-DIBROMOETHANE	ND	U	5
	1,2-DICHLOROETHANE	ND	U	5
	1,3,5-TRIMETHYLBENZENE	150		10
	2-BUTANONE	ND	U	10
	2-CHLOROTOLUENE	ND	U	10
	2-HEXANONE	ND	U	20
	4-METHYL-2-PENTANONE	ND	U	20
	ACETONE	ND	U	10
	BENZENE	3600		50
	CARBON DISULFIDE	ND	U	20
	CHLOROMETHANE	ND	U	5
	CIS-1,2-DICHLOROETHENE	ND	U	5
	DICHLORODIFLUOROMETHANE	ND	U	5
	ETHYLBENZENE	1300		10
	ISOPROPYLBENZENE	190		5
	M,P-XYLENES	3100		10
	METHYL TERT-BUTYL ETHER	ND	U	5
	METHYLENE CHLORIDE	ND	U	10
	NAPHTHALENE	120		5
	N-BUTYLBENZENE	48		10
	N-PROPYLBENZENE	110		10
	O-XYLENE	1400		10
	P-ISOPROPYLTOLUENE	83		10
	SEC-BUTYLBENZENE	19		5
	TERT-BUTYLBENZENE	ND	U	10
	TETRACHLOROETHENE	ND	U	5
	TOLUENE	420		5
	TRANS-1,2-DICHLOROETHENE	ND	U	5
	TRICHLOROETHENE	ND	U	5
	TRICHLOROFLUOROMETHANE	ND	U	5
	VINYL CHLORIDE	ND	U	5
	XYLENES	4500		5

Refer to notes at the end of the table.

Table 8
Analytical Data Table for KAFB-106064

Notes:

Sampling frequency for each analytical method is outlined in Table 4.

a. EPA analytical methods listed are for the most recent sampling event.

b. Samples were collected using Geotech Bladder Pumps.

c. Samples were recollected (except for QuantArray-Chlor analysis) using replacement QED Bladder Pumps.

-- = Not applicable.

δ2H - Delta Deuterium.

0/00 - Per mil.

cells/mL = Cells per milliliter.

EPA = Environmental Protection Agency.

FD = Field duplicate.

ID = Identification.

J = Estimated value, concentration is less than LOQ but greater than laboratory method detection limit (DL).

J+ = Estimated value, concentration is less than LOQ but greater than laboratory method detection limit (DL); biased high.

J- = Estimated value, concentration is less than LOQ but greater than laboratory method detection limit (DL); biased low.

KAFB = Kirtland Air Force Base.

LOQ = Limit of Quantitation

µg/L = Microgram per liter.

mg/L = Milligram per liter.

NA = Not analyzed.

ND = Not detected.

NS = Not sampled.

REG = Regular/parent sample.

U = Analyte was not detected. The reported numerical value is at or below the LOQ.

UJ = Analyte was not detected. The reported value is estimated.

VAL QUAL = Validation qualifier.

VFA - Volatile fatty acid.

VOC = Volatile organic compound.

Table 9
Analytical Data Table for KAFB-106EX1

Phase Designation		Original Baseline ^b			New Baseline - QED Pumps ^c			Phase 1 Recirculation					
Sample ID		106EX1-BL-062917			106EX1-BL-092617			106EX1-P1R-100417			106EX1-P1R-100617		
Sample Date		6/29/2017			9/26/2017			10/4/2017			10/6/2017		
Sample Purpose		REG			REG			REG			REG		
Chemical Class and Analytical Method ^a	Parameter	Result	Val Qual	LOQ	Result	Val Qual	LOQ	Result	Val Qual	LOQ	Result	Val Qual	LOQ
Microbial Community (cells/mL) QuantArray-Chlor	1,1 DCA Reductase (DCA)	ND	U	4.9	NS	--	--	NS	--	--	NS	--	--
	1,2 DCA Reductase (DCAR)	ND	U	4.9	NS	--	--	NS	--	--	NS	--	--
	BAV1 Vinyl Chloride Reductase (BVC)	ND	U	0.5	NS	--	--	NS	--	--	NS	--	--
	cer A Reductase	NA	--	--	NS	--	--	NS	--	--	NS	--	--
	Chloroform Reductase (CFR)	ND	U	4.9	NS	--	--	NS	--	--	NS	--	--
	Dehalobacter DCM (DCM)	ND	U	4.9	NS	--	--	NS	--	--	NS	--	--
	Dehalobacter spp. (DHBt)	87400		4.9	NS	--	--	NS	--	--	NS	--	--
	Dehalobium chlorocoercia (DECO)	18700		4.9	NS	--	--	NS	--	--	NS	--	--
	Dehalococcoides (DHC)	ND	U	0.5	NS	--	--	NS	--	--	NS	--	--
	Dehalogenimonas spp. (DHG)	ND	U	4.9	NS	--	--	NS	--	--	NS	--	--
	Desulfitobacterium spp. (DSB)	370000		4.9	NS	--	--	NS	--	--	NS	--	--
	Desulfuromonas spp. (DSM)	6.3		4.9	NS	--	--	NS	--	--	NS	--	--
	Dichloromethane Dehalogenase (DCMA)	ND	U	4.9	NS	--	--	NS	--	--	NS	--	--
	Epoxyalkane Transferase (EtnE)	2480		4.9	NS	--	--	NS	--	--	NS	--	--
	Ethene Monooxygenase (EtnC)	ND	U	4.9	NS	--	--	NS	--	--	NS	--	--
	Methanogens (MGN)	742		4.9	NS	--	--	NS	--	--	NS	--	--
	PCE Reductase (PCE-1)	NS	--	--	NS	--	--	NS	--	--	NS	--	--
	Phenol Hydroxylase (PHE)	143000		4.9	NS	--	--	NS	--	--	NS	--	--
	PMMO	88.3		4.9	NS	--	--	NS	--	--	NS	--	--
	Soluble Methane Monooxygenase (SMMO)	3850		4.9	NS	--	--	NS	--	--	NS	--	--
	Sulfate Reducing Bacteria (APS)	119000		4.9	NS	--	--	NS	--	--	NS	--	--
	tceA Reductase (TCE)	ND	U	0.5	NS	--	--	NS	--	--	NS	--	--
	Toluene Dioxygenase (TOD)	51.4		4.9	NS	--	--	NS	--	--	NS	--	--
	Toluene Monooxygenase (RMO)	404000		4.9	NS	--	--	NS	--	--	NS	--	--
	Toluene Monooxygenase 2 (RDEG)	114000		4.9	NS	--	--	NS	--	--	NS	--	--
	Total Eubacteria (EBAC)	959000		4.9	NS	--	--	NS	--	--	NS	--	--
	trans-1,2-DCE Reductase (TDR)	NA	--	--	NS	--	--	NS	--	--	NS	--	--
	Trichlorobenzene Dioxygenase (TCBO)	ND	U	4.9	NS	--	--	NS	--	--	NS	--	--
Vinyl Chloride Reductase (VCR)	ND	U	0.5										
EDB (µg/L) EPA Method 8011	1,2-DIBROMOETHANE	28.5		1.89	31.3	J+	1.94	NS	--	--	NS	--	--
VFAs (mg/L) EPA Method 300m	ACETIC ACID	ND	U	1	4.51		1	NS	--	--	NS	--	--
	BUTYRIC ACID	ND	U	1	ND	U	1	NS	--	--	NS	--	--
	FORMIC ACID	ND	U	1	ND	U	1	NS	--	--	NS	--	--
	LACTIC ACID	ND	U	1	ND	U	1	NS	--	--	NS	--	--
	PROPIONIC ACID	ND	U	1	ND	U	1	NS	--	--	NS	--	--
	PYRUVIC ACID	ND	U	1	ND	U	1	NS	--	--	NS	--	--
	VALERIC ACID	ND	U	1	ND	U	1	NS	--	--	NS	--	--
Fluorometric (µg/L) Spectrofluorophotometry	FLUORESC EIN	ND	U	0.01	ND	U	0.01	ND	U	0.01	ND	U	0.01
Reduced Gases (µg/L) RSKSOP-175	ACETYLENE	ND	U	10	ND	U	10	NS	--	--	NS	--	--
	ETHANE	0.67	J	4	ND	U	4	NS	--	--	NS	--	--
	ETHYLENE	1.13	J	5	3.08	J	5	NS	--	--	NS	--	--
	METHANE	2.61		2	14.3		2	NS	--	--	NS	--	--
	PROPANE	ND	U	6	ND	U	6	NS	--	--	NS	--	--
General Chemistry (mg/L) SM2320b, EPA Method 300, EPA Method 353.2, SM4500 Pe ^c	ALKALINITY	246		1	313		1	NS	--	--	NS	--	--
	BROMIDE	0.373	J-	0.125	0.0952	J	0.25	NS	--	--	NS	--	--
	CHLORIDE	12.3		0.33	12.5		0.66	NS	--	--	NS	--	--
	IODIDE	ND	U	0.2	ND	U	0.75	NS	--	--	NS	--	--
	NITRATE	NA	--	--	NA	--	--	NS	--	--	NS	--	--
	NITRITE	NA	--	--	NA	--	--	NS	--	--	NS	--	--
	NITROGEN, NITRATE-NITRITE	ND	U	0.375	ND	U	0.375	NS	--	--	NS	--	--
	O-PHOSPHATE (AS P)	0.0958		0.02	0.219	J+	0.02	NS	--	--	NS	--	--
	ORTHOPHOSPHATE	NA	--	--	NA	--	--	NS	--	--	NS	--	--
	PHOSPHORUS	NA	--	--	NA	--	--	NS	--	--	NS	--	--
SULFATE	7.48		1	2.05	J	2	NS	--	--	NS	--	--	

Table 9
Analytical Data Table for KAFB-106EX1

Phase Designation		Original Baseline ^b			New Baseline - QED Pumps ^c			Phase 1 Recirculation					
Sample ID		106EX1-BL-062917			106EX1-BL-092617			106EX1-P1R-100417			106EX1-P1R-100617		
Sample Date		6/29/2017			9/26/2017			10/4/2017			10/6/2017		
Sample Purpose		REG			REG			REG			REG		
Chemical Class and Analytical Method ^a	Parameter	Result	Val Qual	LOQ	Result	Val Qual	LOQ	Result	Val Qual	LOQ	Result	Val Qual	LOQ
Metals (mg/L) EPA Method 6010	LEAD	NS	--	--	NS	--	--	NS	--	--	NS	--	--
Dissolved Metals (mg/L) EPA Method 6010	IRON	1.33		0.06	5.36		0.06	NS	--	--	NS	--	--
	MANGANESE	1.89		0.006	3.07		0.006	NS	--	--	NS	--	--
δ2H (‰) Mass Spectrometry, USGS Reston, VA	DELTA2H	-94.24		-99	-94.04		-99	-94.57		-99	-95.56		-99
CSIA EDB δ13C (‰) Kuder et al, 2012	EDB δ	NA	--	--	-9.0 ±2‰	--	--	NS	--	--	NS	--	--
VOCs (µg/L) EPA Method 8260	1,1,2-TRICHLOROETHANE	ND	U	25	ND	U	50	NS	--	--	NS	--	--
	1,2,4-TRICHLOROBENZENE	NA	--	--	NA	--	--	NS	--	--	NS	--	--
	1,2,4-TRIMETHYLBENZENE	167		25	215		50	NS	--	--	NS	--	--
	1,2-DIBROMOETHANE	32.3	J	25	40.1	J	50	NS	--	--	NS	--	--
	1,2-DICHLOROETHANE	ND	U	25	ND	U	50	NS	--	--	NS	--	--
	1,3,5-TRIMETHYLBENZENE	55.2		25	69.6	J	50	NS	--	--	NS	--	--
	2-BUTANONE	215	J	250	287	J	500	NS	--	--	NS	--	--
	2-CHLOROTOLUENE	ND	U	25	ND	U	50	NS	--	--	NS	--	--
	2-HEXANONE	153	J	125	239	J	250	NS	--	--	NS	--	--
	4-METHYL-2-PENTANONE	62.8	J	125	ND	U	250	NS	--	--	NS	--	--
	ACETONE	673		250	951	J	500	NS	--	--	NS	--	--
	BENZENE	1100		25	2090		50	NS	--	--	NS	--	--
	CARBON DISULFIDE	ND	U	25	27.2	J	50	NS	--	--	NS	--	--
	CHLOROMETHANE	ND	U	25	ND	U	50	NS	--	--	NS	--	--
	CIS-1,2-DICHLOROETHENE	NA	--	--	NA	--	--	NS	--	--	NS	--	--
	DICHLORODIFLUOROMETHANE	ND	U	50	ND	U	100	NS	--	--	NS	--	--
	ETHYLBENZENE	526		25	797		50	NS	--	--	NS	--	--
	ISOPROPYLBENZENE	36	J+	25	58	J	50	NS	--	--	NS	--	--
	M,P-XYLENES	NA	--	--	NA	--	--	NS	--	--	NS	--	--
	METHYL TERT-BUTYL ETHER	ND	U	25	ND	U	50	NS	--	--	NS	--	--
	METHYLENE CHLORIDE	ND	U	50	ND	U	100	NS	--	--	NS	--	--
	NAPHTHALENE	68.9	J+	25	114		50	NS	--	--	NS	--	--
	N-BUTYLBENZENE	ND	U	25	ND	U	50	NS	--	--	NS	--	--
	N-PROPYLBENZENE	46.6	J	25	61.7	J	50	NS	--	--	NS	--	--
	O-XYLENE	NA	--	--	NA	--	--	NS	--	--	NS	--	--
	P-ISOPROPYLTOLUENE	ND	U	25	ND	U	50	NS	--	--	NS	--	--
	SEC-BUTYLBENZENE	ND	U	25	ND	U	50	NS	--	--	NS	--	--
	TERT-BUTYLBENZENE	ND	U	25	ND	U	50	NS	--	--	NS	--	--
	TETRACHLOROETHENE	NA	--	--	NA	--	--	NS	--	--	NS	--	--
	TOLUENE	4380		25	6300		50	NS	--	--	NS	--	--
	TRANS-1,2-DICHLOROETHENE	NA	--	--	NA	--	--	NS	--	--	NS	--	--
TRICHLOROETHENE	ND	U	25	ND	U	50	NS	--	--	NS	--	--	
TRICHLOROFUOROMETHANE	ND	U	50	ND	U	100	NS	--	--	NS	--	--	
VINYL CHLORIDE	NA	--	--	NA	--	--	NS	--	--	NS	--	--	
XYLENES	1690		75	2590		150	NS	--	--	NS	--	--	

Refer to notes at the end of the table.

Table 9
Analytical Data Table for KAFB-106EX1

Phase Designation		Phase 1 Recirculation						Phase 1 Recirculation					
Sample ID		106EX1-P1R-100917			106EX1-P1R-101217			106EX1-P1R-101617			106EX1-P1R-101617-FD		
Sample Date		10/9/2017			10/12/2017			10/16/2017			10/16/2017		
Sample Purpose		REG			REG			REG			FD		
Chemical Class and Analytical Method ^a	Parameter	Result	Val Qual	LOQ	Result	Val Qual	LOQ	Result	Val Qual	LOQ	Result	Val Qual	LOQ
Microbial Community (cells/mL) QuantArray-Chlor	1,1 DCA Reductase (DCA)	NS	--	--	NS	--	--	NS	--	--	NS	--	--
	1,2 DCA Reductase (DCAR)	NS	--	--	NS	--	--	NS	--	--	NS	--	--
	BAV1 Vinyl Chloride Reductase (BVC)	NS	--	--	NS	--	--	NS	--	--	NS	--	--
	cer A Reductase	NS	--	--	NS	--	--	NS	--	--	NS	--	--
	Chloroform Reductase (CFR)	NS	--	--	NS	--	--	NS	--	--	NS	--	--
	Dehalobacter DCM (DCM)	NS	--	--	NS	--	--	NS	--	--	NS	--	--
	Dehalobacter spp. (DHBt)	NS	--	--	NS	--	--	NS	--	--	NS	--	--
	Dehalobium chlorocoercia (DECO)	NS	--	--	NS	--	--	NS	--	--	NS	--	--
	Dehalococcoides (DHC)	NS	--	--	NS	--	--	NS	--	--	NS	--	--
	Dehalogenimonas spp. (DHG)	NS	--	--	NS	--	--	NS	--	--	NS	--	--
	Desulfitobacterium spp. (DSB)	NS	--	--	NS	--	--	NS	--	--	NS	--	--
	Desulfuromonas spp. (DSM)	NS	--	--	NS	--	--	NS	--	--	NS	--	--
	Dichloromethane Dehalogenase (DCMA)	NS	--	--	NS	--	--	NS	--	--	NS	--	--
	Epoxyalkane Transferase (EtnE)	NS	--	--	NS	--	--	NS	--	--	NS	--	--
	Ethene Monooxygenase (EtnC)	NS	--	--	NS	--	--	NS	--	--	NS	--	--
	Methanogens (MGN)	NS	--	--	NS	--	--	NS	--	--	NS	--	--
	PCE Reductase (PCE-1)	NS	--	--	NS	--	--	NS	--	--	NS	--	--
	Phenol Hydroxylase (PHE)	NS	--	--	NS	--	--	NS	--	--	NS	--	--
	PMMO	NS	--	--	NS	--	--	NS	--	--	NS	--	--
	Soluble Methane Monooxygenase (SMMO)	NS	--	--	NS	--	--	NS	--	--	NS	--	--
	Sulfate Reducing Bacteria (APS)	NS	--	--	NS	--	--	NS	--	--	NS	--	--
	tceA Reductase (TCE)	NS	--	--	NS	--	--	NS	--	--	NS	--	--
	Toluene Dioxygenase (TOD)	NS	--	--	NS	--	--	NS	--	--	NS	--	--
	Toluene Monooxygenase (RMO)	NS	--	--	NS	--	--	NS	--	--	NS	--	--
Toluene Monooxygenase 2 (RDEG)	NS	--	--	NS	--	--	NS	--	--	NS	--	--	
Total Eubacteria (EBAC)	NS	--	--	NS	--	--	NS	--	--	NS	--	--	
trans-1,2-DCE Reductase (TDR)	NS	--	--	NS	--	--	NS	--	--	NS	--	--	
Trichlorobenzene Dioxygenase (TCBO)	NS	--	--	NS	--	--	NS	--	--	NS	--	--	
Vinyl Chloride Reductase (VCR)													
EDB (µg/L) EPA Method 8011	1,2-DIBROMOETHANE	NS	--	--	NS	--	--	NS	--	--	NS	--	--
VFAs (mg/L) EPA Method 300m	ACETIC ACID	NS	--	--	NS	--	--	NS	--	--	NS	--	--
	BUTYRIC ACID	NS	--	--	NS	--	--	NS	--	--	NS	--	--
	FORMIC ACID	NS	--	--	NS	--	--	NS	--	--	NS	--	--
	LACTIC ACID	NS	--	--	NS	--	--	NS	--	--	NS	--	--
	PROPIONIC ACID	NS	--	--	NS	--	--	NS	--	--	NS	--	--
	PYRUVIC ACID	NS	--	--	NS	--	--	NS	--	--	NS	--	--
	VALERIC ACID	NS	--	--	NS	--	--	NS	--	--	NS	--	--
Fluorometric (µg/L) Spectrofluorophotometry	FLUORESC EIN	ND	U	0.01	0.009		0.01	0.735		0.01	0.773		0.01
Reduced Gases (µg/L) RSKSOP-175	ACETYLENE	NS	--	--	NS	--	--	NS	--	--	NS	--	--
	ETHANE	NS	--	--	NS	--	--	NS	--	--	NS	--	--
	ETHYLENE	NS	--	--	NS	--	--	NS	--	--	NS	--	--
	METHANE	NS	--	--	NS	--	--	NS	--	--	NS	--	--
	PROPANE	NS	--	--	NS	--	--	NS	--	--	NS	--	--
General Chemistry (mg/L) SM2320b, EPA Method 300, EPA Method 353.2, SM4500 Pe ^c	ALKALINITY	NS	--	--	NS	--	--	NS	--	--	NS	--	--
	BROMIDE	NS	--	--	NS	--	--	NS	--	--	NS	--	--
	CHLORIDE	NS	--	--	NS	--	--	NS	--	--	NS	--	--
	IODIDE	NS	--	--	NS	--	--	NS	--	--	NS	--	--
	NITRATE	NS	--	--	NS	--	--	NS	--	--	NS	--	--
	NITRITE	NS	--	--	NS	--	--	NS	--	--	NS	--	--
	NITROGEN, NITRATE-NITRITE	NS	--	--	NS	--	--	NS	--	--	NS	--	--
	O-PHOSPHATE (AS P)	NS	--	--	NS	--	--	NS	--	--	NS	--	--
	ORTHOPHOSPHATE	NS	--	--	NS	--	--	NS	--	--	NS	--	--
	PHOSPHORUS	NS	--	--	NS	--	--	NS	--	--	NS	--	--
	SULFATE	NS	--	--	NS	--	--	NS	--	--	NS	--	--

Table 9
Analytical Data Table for KAFB-106EX1

Phase Designation		Phase 1 Recirculation						Phase 1 Recirculation					
Sample ID		106EX1-P1R-100917			106EX1-P1R-101217			106EX1-P1R-101617			106EX1-P1R-101617-FD		
Sample Date		10/9/2017			10/12/2017			10/16/2017			10/16/2017		
Sample Purpose		REG			REG			REG			FD		
Chemical Class and Analytical Method ^a	Parameter	Result	Val Qual	LOQ	Result	Val Qual	LOQ	Result	Val Qual	LOQ	Result	Val Qual	LOQ
Metals (mg/L) EPA Method 6010	LEAD	NS	--	--	NS	--	--	NS	--	--	NS	--	--
Dissolved Metals (mg/L) EPA Method 6010	IRON	NS	--	--	NS	--	--	NS	--	--	NS	--	--
	MANGANESE	NS	--	--	NS	--	--	NS	--	--	NS	--	--
δ 2H (‰) Mass Spectrometry, USGS Reston, VA	DELTA2H	-95.92		-99	-95		-99	-92.41		-99	-92.76		-99
CSIA EDB δ 13C (‰) Kuder et al, 2012	EDB δ	NS	--	--	NS	--	--	NS	--	--	NS	--	--
VOCs (µg/L) EPA Method 8260	1,1,2-TRICHLOROETHANE	NS	--	--	NS	--	--	NS	--	--	NS	--	--
	1,2,4-TRICHLOROBENZENE	NS	--	--	NS	--	--	NS	--	--	NS	--	--
	1,2,4-TRIMETHYLBENZENE	NS	--	--	NS	--	--	NS	--	--	NS	--	--
	1,2-DIBROMOETHANE	NS	--	--	NS	--	--	NS	--	--	NS	--	--
	1,2-DICHLOROETHANE	NS	--	--	NS	--	--	NS	--	--	NS	--	--
	1,3,5-TRIMETHYLBENZENE	NS	--	--	NS	--	--	NS	--	--	NS	--	--
	2-BUTANONE	NS	--	--	NS	--	--	NS	--	--	NS	--	--
	2-CHLOROTOLUENE	NS	--	--	NS	--	--	NS	--	--	NS	--	--
	2-HEXANONE	NS	--	--	NS	--	--	NS	--	--	NS	--	--
	4-METHYL-2-PENTANONE	NS	--	--	NS	--	--	NS	--	--	NS	--	--
	ACETONE	NS	--	--	NS	--	--	NS	--	--	NS	--	--
	BENZENE	NS	--	--	NS	--	--	NS	--	--	NS	--	--
	CARBON DISULFIDE	NS	--	--	NS	--	--	NS	--	--	NS	--	--
	CHLOROMETHANE	NS	--	--	NS	--	--	NS	--	--	NS	--	--
	CIS-1,2-DICHLOROETHENE	NS	--	--	NS	--	--	NS	--	--	NS	--	--
	DICHLORODIFLUOROMETHANE	NS	--	--	NS	--	--	NS	--	--	NS	--	--
	ETHYLBENZENE	NS	--	--	NS	--	--	NS	--	--	NS	--	--
	ISOPROPYLBENZENE	NS	--	--	NS	--	--	NS	--	--	NS	--	--
	M,P-XYLENES	NS	--	--	NS	--	--	NS	--	--	NS	--	--
	METHYL TERT-BUTYL ETHER	NS	--	--	NS	--	--	NS	--	--	NS	--	--
	METHYLENE CHLORIDE	NS	--	--	NS	--	--	NS	--	--	NS	--	--
	NAPHTHALENE	NS	--	--	NS	--	--	NS	--	--	NS	--	--
	N-BUTYLBENZENE	NS	--	--	NS	--	--	NS	--	--	NS	--	--
	N-PROPYLBENZENE	NS	--	--	NS	--	--	NS	--	--	NS	--	--
	O-XYLENE	NS	--	--	NS	--	--	NS	--	--	NS	--	--
	P-ISOPROPYLTOLUENE	NS	--	--	NS	--	--	NS	--	--	NS	--	--
	SEC-BUTYLBENZENE	NS	--	--	NS	--	--	NS	--	--	NS	--	--
	TERT-BUTYLBENZENE	NS	--	--	NS	--	--	NS	--	--	NS	--	--
	TETRACHLOROETHENE	NS	--	--	NS	--	--	NS	--	--	NS	--	--
	TOLUENE	NS	--	--	NS	--	--	NS	--	--	NS	--	--
	TRANS-1,2-DICHLOROETHENE	NS	--	--	NS	--	--	NS	--	--	NS	--	--
	TRICHLOROETHENE	NS	--	--	NS	--	--	NS	--	--	NS	--	--
	TRICHLOROFUOROMETHANE	NS	--	--	NS	--	--	NS	--	--	NS	--	--
	VINYL CHLORIDE	NS	--	--	NS	--	--	NS	--	--	NS	--	--
	XYLENES	NS	--	--	NS	--	--	NS	--	--	NS	--	--

Refer to notes at the end of the table.

Table 9
Analytical Data Table for KAFB-106EX1

Phase Designation		Phase 1 Recirculation						Phase 1 Recirculation					
Sample ID		106EX1-P1R-102017			106EX1-P1R-102417			106EX1-P1R-102417-FD			106EX1-P1R-110117		
Sample Date		10/20/2017			10/24/2017			10/24/2017			11/1/2017		
Sample Purpose		REG			REG			FD			REG		
Chemical Class and Analytical Method ^a	Parameter	Result	Val Qual	LOQ	Result	Val Qual	LOQ	Result	Val Qual	LOQ	Result	Val Qual	LOQ
Microbial Community (cells/mL) QuantArray-Chlor	1,1 DCA Reductase (DCA)	NS	--	--	NS	--	--	NS	--	--	NS	--	--
	1,2 DCA Reductase (DCAR)	NS	--	--	NS	--	--	NS	--	--	NS	--	--
	BAV1 Vinyl Chloride Reductase (BVC)	NS	--	--	NS	--	--	NS	--	--	NS	--	--
	cer A Reductase	NS	--	--	NS	--	--	NS	--	--	NS	--	--
	Chloroform Reductase (CFR)	NS	--	--	NS	--	--	NS	--	--	NS	--	--
	Dehalobacter DCM (DCM)	NS	--	--	NS	--	--	NS	--	--	NS	--	--
	Dehalobacter spp. (DHBt)	NS	--	--	NS	--	--	NS	--	--	NS	--	--
	Dehalobium chlorocoercia (DECO)	NS	--	--	NS	--	--	NS	--	--	NS	--	--
	Dehalococcoides (DHC)	NS	--	--	NS	--	--	NS	--	--	NS	--	--
	Dehalogenimonas spp. (DHG)	NS	--	--	NS	--	--	NS	--	--	NS	--	--
	Desulfitobacterium spp. (DSB)	NS	--	--	NS	--	--	NS	--	--	NS	--	--
	Desulfuromonas spp. (DSM)	NS	--	--	NS	--	--	NS	--	--	NS	--	--
	Dichloromethane Dehalogenase (DCMA)	NS	--	--	NS	--	--	NS	--	--	NS	--	--
	Epoxyalkane Transferase (EtnE)	NS	--	--	NS	--	--	NS	--	--	NS	--	--
	Ethene Monooxygenase (EtnC)	NS	--	--	NS	--	--	NS	--	--	NS	--	--
	Methanogens (MGN)	NS	--	--	NS	--	--	NS	--	--	NS	--	--
	PCE Reductase (PCE-1)	NS	--	--	NS	--	--	NS	--	--	NS	--	--
	Phenol Hydroxylase (PHE)	NS	--	--	NS	--	--	NS	--	--	NS	--	--
	PMMO	NS	--	--	NS	--	--	NS	--	--	NS	--	--
	Soluble Methane Monooxygenase (SMMO)	NS	--	--	NS	--	--	NS	--	--	NS	--	--
	Sulfate Reducing Bacteria (APS)	NS	--	--	NS	--	--	NS	--	--	NS	--	--
	tceA Reductase (TCE)	NS	--	--	NS	--	--	NS	--	--	NS	--	--
	Toluene Dioxygenase (TOD)	NS	--	--	NS	--	--	NS	--	--	NS	--	--
	Toluene Monooxygenase (RMO)	NS	--	--	NS	--	--	NS	--	--	NS	--	--
Toluene Monooxygenase 2 (RDEG)	NS	--	--	NS	--	--	NS	--	--	NS	--	--	
Total Eubacteria (EBAC)	NS	--	--	NS	--	--	NS	--	--	NS	--	--	
trans-1,2-DCE Reductase (TDR)	NS	--	--	NS	--	--	NS	--	--	NS	--	--	
Trichlorobenzene Dioxygenase (TCBO)	NS	--	--	NS	--	--	NS	--	--	NS	--	--	
Vinyl Chloride Reductase (VCR)	NS	--	--	NS	--	--	NS	--	--	NS	--	--	
EDB (µg/L) EPA Method 8011	1,2-DIBROMOETHANE	NS	--	--	53.6		1.92	50.4		1.9	NS	--	--
VFAs (mg/L) EPA Method 300m	ACETIC ACID	NS	--	--	ND	U	1	ND	U	1	NS	--	--
	BUTYRIC ACID	NS	--	--	ND	U	1	ND	U	1	NS	--	--
	FORMIC ACID	NS	--	--	ND	U	1	ND	U	1	NS	--	--
	LACTIC ACID	NS	--	--	ND	U	1	ND	U	1	NS	--	--
	PROPIONIC ACID	NS	--	--	ND	U	1	ND	U	1	NS	--	--
	PYRUVIC ACID	NS	--	--	ND	U	1	ND	U	1	NS	--	--
	VALERIC ACID	NS	--	--	ND	U	1	ND	U	1	NS	--	--
Fluorometric (µg/L) Spectrofluorophotometry	FLUORESC EIN	1.847		0.01	2.625		0.01				3.733		0.01
Reduced Gases (µg/L) RSKSOP-175	ACETYLENE	NS	--	--	ND	U	10	ND	U	10	NS	--	--
	ETHANE	NS	--	--	ND	U	4	ND	U	4	NS	--	--
	ETHYLENE	NS	--	--	3.07	J	5	3.53	J	5	NS	--	--
	METHANE	NS	--	--	1.02	J	2	1.2	J	2	NS	--	--
	PROPANE	NS	--	--	ND	U	6	ND	U	6	NS	--	--
General Chemistry (mg/L) SM2320b, EPA Method 300, EPA Method 353.2, SM4500 Pe ^c	ALKALINITY	NS	--	--	267		1	268		1	NS	--	--
	BROMIDE	NS	--	--	0.264		0.125	0.257		0.125	NS	--	--
	CHLORIDE	NS	--	--	15.4		0.33	15.5		0.33	NS	--	--
	IODIDE	NS	--	--	ND	U	0.75	ND	U	0.75	NS	--	--
	NITRATE	NS	--	--	NA	--	--	NA	--	--	NS	--	--
	NITRITE	NS	--	--	NA	--	--	NA	--	--	NS	--	--
	NITROGEN, NITRATE-NITRITE	NS	--	--	ND	U	0.375	ND	U	0.375	NS	--	--
	O-PHOSPHATE (AS P)	NS	--	--	ND	U	0.02	ND	U	0.02	NS	--	--
	ORTHOPHOSPHATE	NS	--	--	NA	--	--	NA	--	--	NS	--	--
	PHOSPHORUS	NS	--	--	NA	--	--	NA	--	--	NS	--	--
SULFATE	NS	--	--	14.6		1	14.3		1	NS	--	--	

**Table 9
Analytical Data Table for KAFB-106EX1**

Phase Designation		Phase 1 Recirculation						Phase 1 Recirculation					
Sample ID		106EX1-P1R-102017			106EX1-P1R-102417			106EX1-P1R-102417-FD			106EX1-P1R-110117		
Sample Date		10/20/2017			10/24/2017			10/24/2017			11/1/2017		
Sample Purpose		REG			REG			FD			REG		
Chemical Class and Analytical Method ^a	Parameter	Result	Val Qual	LOQ	Result	Val Qual	LOQ	Result	Val Qual	LOQ	Result	Val Qual	LOQ
Metals (mg/L) EPA Method 6010	LEAD	NS	--	--	NS	--	--	NS	--	--	NS	--	--
Dissolved Metals (mg/L) EPA Method 6010	IRON	NS	--	--	0.248		0.06	0.25		0.06	NS	--	--
	MANGANESE	NS	--	--	1.57		0.006	1.59		0.006	NS	--	--
δ2H (‰) Mass Spectrometry, USGS Reston, VA	DELTA2H	-92.35		-99	-93.32		-99	-94.31		-99	-89.6		-99
CSIA EDB δ13C (‰) Kuder et al, 2012	EDB δ	NS	--	--	NS	--	--	NS	--	--	NS	--	--
VOCs (µg/L) EPA Method 8260	1,1,2-TRICHLOROETHANE	NS	--	--	ND	U	25	ND	U	25	NS	--	--
	1,2,4-TRICHLOROBENZENE	NS	--	--	NS	--	--	NS	--	--	NS	--	--
	1,2,4-TRIMETHYLBENZENE	NS	--	--	255		25	220		25	NS	--	--
	1,2-DIBROMOETHANE	NS	--	--	57.6		25	67.8		25	NS	--	--
	1,2-DICHLOROETHANE	NS	--	--	ND	U	25	ND	U	25	NS	--	--
	1,3,5-TRIMETHYLBENZENE	NS	--	--	92.3		25	81.2		25	NS	--	--
	2-BUTANONE	NS	--	--	ND	U	250	148	J	250	NS	--	--
	2-CHLOROTOLUENE	NS	--	--	ND	U	25	ND	U	25	NS	--	--
	2-HEXANONE	NS	--	--	103	J	125	106	J	125	NS	--	--
	4-METHYL-2-PENTANONE	NS	--	--	ND	U	125	68.6	J	125	NS	--	--
	ACETONE	NS	--	--	719		250	853		250	NS	--	--
	BENZENE	NS	--	--	2910		25	2680		25	NS	--	--
	CARBON DISULFIDE	NS	--	--	ND	U	25	ND	U	25	NS	--	--
	CHLOROMETHANE	NS	--	--	ND	U	25	ND	U	25	NS	--	--
	CIS-1,2-DICHLOROETHENE	NS	--	--	NA	--	--	NA	--	--	NS	--	--
	DICHLORODIFLUOROMETHANE	NS	--	--	ND	U	50	ND	U	50	NS	--	--
	ETHYLBENZENE	NS	--	--	688		25	620		25	NS	--	--
	ISOPROPYLBENZENE	NS	--	--	61.4		25	53		25	NS	--	--
	M,P-XYLENES	NS	--	--	NA	--	--	NA	--	--	NS	--	--
	METHYL TERT-BUTYL ETHER	NS	--	--	ND	U	25	ND	U	25	NS	--	--
	METHYLENE CHLORIDE	NS	--	--	ND	U	50	ND	U	50	NS	--	--
	NAPHTHALENE	NS	--	--	72.4		25	68.6		25	NS	--	--
	N-BUTYLBENZENE	NS	--	--	14.6	J	25	12.9	J	25	NS	--	--
	N-PROPYLBENZENE	NS	--	--	63.9		25	58.1		25	NS	--	--
	O-XYLENE	NS	--	--	NA	--	--	NA	--	--	NS	--	--
	P-ISOPROPYLTOLUENE	NS	--	--	ND	U	25	13.5	J	25	NS	--	--
	SEC-BUTYLBENZENE	NS	--	--	ND	U	25	13.5	J	25	NS	--	--
	TERT-BUTYLBENZENE	NS	--	--	ND	U	25	ND	U	25	NS	--	--
	TETRACHLOROETHENE	NS	--	--	NA	--	--	NA	--	--	NS	--	--
	TOLUENE	NS	--	--	5610		25	5060		25	NS	--	--
	TRANS-1,2-DICHLOROETHENE	NS	--	--	NA	--	--	NA	--	--	NS	--	--
	TRICHLOROETHENE	NS	--	--	ND	U	25	ND	U	25	NS	--	--
	TRICHLOROFUOROMETHANE	NS	--	--	ND	U	50	ND	U	50	NS	--	--
	VINYL CHLORIDE	NS	--	--	NA	--	--	NA	--	--	NS	--	--
	XYLENES	NS	--	--	2470		75	2240		75	NS	--	--

Refer to notes at the end of the table.

Table 9
Analytical Data Table for KAFB-106EX1

Phase Designation		Phase 1 Passive						Phase 2 Recirculation					
Sample ID		106EX1-P1P-111617			106EX1-P1P-112917			106EX1-P2R-011018			106EX1-P2R-011618		
Sample Date		11/16/2017			11/29/2017			1/10/2018			1/16/2018		
Sample Purpose		REG			REG			REG			REG		
Chemical Class and Analytical Method ^a	Parameter	Result	Val Qual	LOQ	Result	Val Qual	LOQ	Result	Val Qual	LOQ	Result	Val Qual	LOQ
Microbial Community (cells/mL) QuantArray-Chlor	1,1 DCA Reductase (DCA)	NS	--	--	ND	U	6.6	NS	--	--	NS	--	--
	1,2 DCA Reductase (DCAR)	NS	--	--	ND	U	6.6	NS	--	--	NS	--	--
	BAV1 Vinyl Chloride Reductase (BVC)	NS	--	--	ND	U	0.7	NS	--	--	NS	--	--
	cer A Reductase	NS	--	--	NA	--	--	NS	--	--	NS	--	--
	Chloroform Reductase (CFR)	NS	--	--	ND	U	6.6	NS	--	--	NS	--	--
	Dehalobacter DCM (DCM)	NS	--	--	ND	U	6.6	NS	--	--	NS	--	--
	Dehalobacter spp. (DHBt)	NS	--	--	125000		6.6	NS	--	--	NS	--	--
	Dehalobium chlorocoercia (DECO)	NS	--	--	7140		6.6	NS	--	--	NS	--	--
	Dehalococcoides (DHC)	NS	--	--	ND	U	0.7	NS	--	--	NS	--	--
	Dehalogenimonas spp. (DHG)	NS	--	--	ND	U	6.6	NS	--	--	NS	--	--
	Desulfitobacterium spp. (DSB)	NS	--	--	331000		6.6	NS	--	--	NS	--	--
	Desulfuromonas spp. (DSM)	NS	--	--	ND	U	6.6	NS	--	--	NS	--	--
	Dichloromethane Dehalogenase (DCMA)	NS	--	--	ND	U	6.6	NS	--	--	NS	--	--
	Epoxyalkane Transferase (EtnE)	NS	--	--	138		6.6	NS	--	--	NS	--	--
	Ethene Monooxygenase (EtnC)	NS	--	--	ND	U	6.6	NS	--	--	NS	--	--
	Methanogens (MGN)	NS	--	--	346		6.6	NS	--	--	NS	--	--
	PCE Reductase (PCE-1)	NS	--	--	NA	--	--	NS	--	--	NS	--	--
	Phenol Hydroxylase (PHE)	NS	--	--	22700		6.6	NS	--	--	NS	--	--
	PMMO	NS	--	--	2.7	J	6.6	NS	--	--	NS	--	--
	Soluble Methane Monooxygenase (SMMO)	NS	--	--	1630		6.6	NS	--	--	NS	--	--
	Sulfate Reducing Bacteria (APS)	NS	--	--	89300		6.6	NS	--	--	NS	--	--
	tceA Reductase (TCE)	NS	--	--	ND	U	0.7	NS	--	--	NS	--	--
	Toluene Dioxygenase (TOD)	NS	--	--	22200		6.6	NS	--	--	NS	--	--
	Toluene Monooxygenase (RMO)	NS	--	--	373000		6.6	NS	--	--	NS	--	--
	Toluene Monooxygenase 2 (RDEG)	NS	--	--	227000		6.6	NS	--	--	NS	--	--
Total Eubacteria (EBAC)	NS	--	--	7680000		6.6	NS	--	--	NS	--	--	
trans-1,2-DCE Reductase (TDR)	NS	--	--	NA	--	--	NS	--	--	NS	--	--	
Trichlorobenzene Dioxygenase (TCBO)	NS	--	--	157		6.6	NS	--	--	NS	--	--	
Vinyl Chloride Reductase (VCR)				ND	U	0.7	NS	--	--	NS	--	--	
EDB (µg/L) EPA Method 8011	1,2-DIBROMOETHANE	21		3.81	12.9		1.87	25.7		1.88	62.2		1.91
VFAs (mg/L) EPA Method 300m	ACETIC ACID	7.65		1	10.1		1	3.53		1	4.45		1
	BUTYRIC ACID	ND	U	1	ND	U	1	ND	U	1	ND	U	1
	FORMIC ACID	ND	U	1	ND	U	1	ND	U	1	ND	U	1
	LACTIC ACID	ND	U	1	ND	U	1	1.97		1	0.75	J	1
	PROPIONIC ACID	ND	U	1	ND	U	1	0.88	J	1	0.32	J	1
	PYRUVIC ACID	ND	U	1	ND	U	1	ND	U	1	ND	U	1
	VALERIC ACID	ND	U	1	ND	U	1	ND	U	1	ND	U	1
Fluorometric (µg/L) Spectrofluorophotometry	FLUORESCIEIN	3.947		0.01	5.251		0.01	NS	--	--	NS	--	--
Reduced Gases (µg/L) RSKSOP-175	ACETYLENE	ND	U	10	ND	U	10	ND	U	10	ND	U	10
	ETHANE	ND	U	4	ND	U	4	1.74	J	4	2.66	J	4
	ETHYLENE	2.77	J	5	5.17		5	6.91		5	8.34		5
	METHANE	0.81	J	2	2.49		2	2.33		2	2.92		2
	PROPANE	ND	U	6	ND	U	6	ND	U	6	2.68	J	6
General Chemistry (mg/L) SM2320b, EPA Method 300, EPA Method 353.2, SM4500 Pe ^c	ALKALINITY	246		1	264		1	281	J-	1	280		1
	BROMIDE	0.327		0.125	0.395		0.125	0.366	J-	0.125	0.403		0.125
	CHLORIDE	18.5		0.33	20.7		0.33	25.8		0.33	29.6		0.33
	IODIDE	ND	U	0.75	ND	U	0.75	0.25	J	0.75	0.58	J	0.75
	NITRATE	NA	--	--	NA	--	--	NA	--	--	NA	--	--
	NITRITE	NA	--	--	NA	--	--	NA	--	--	NA	--	--
	NITROGEN, NITRATE-NITRITE	ND	U	0.375	ND	U	0.375	ND	U	0.375	ND	U	0.375
	O-PHOSPHATE (AS P)	0.0153	J	0.02	ND	U	0.02	0.0136	J	0.02	ND	U	0.02
	ORTHOPHOSPHATE	NA	--	--	NA	--	--	NA	--	--	NA	--	--
	PHOSPHORUS	NA	--	--	NA	--	--	NA	--	--	NA	--	--
SULFATE	10.1		1	9.82		1	8.43	J+	1	7.21		1	

Table 9
Analytical Data Table for KAFB-106EX1

Phase Designation		Phase 1 Passive						Phase 2 Recirculation					
Sample ID		106EX1-P1P-111617			106EX1-P1P-112917			106EX1-P2R-011018			106EX1-P2R-011618		
Sample Date		11/16/2017			11/29/2017			1/10/2018			1/16/2018		
Sample Purpose		REG			REG			REG			REG		
Chemical Class and Analytical Method ^a	Parameter	Result	Val Qual	LOQ	Result	Val Qual	LOQ	Result	Val Qual	LOQ	Result	Val Qual	LOQ
Metals (mg/L) EPA Method 6010	LEAD	NS	--	--	NS	--	--	NS	--	--	NS	--	--
Dissolved Metals (mg/L) EPA Method 6010	IRON	1.45		0.06	1.63		0.06	0.521		0.06	0.535		0.06
	MANGANESE	1.94		0.006	2.27		0.006	2.33		0.006	2.49		0.006
δ2H (‰) Mass Spectrometry, USGS Reston, VA	DELTA2H	-91.2		-99	-88.51		-99	NS	--	--	NS	--	--
CSIA EDB δ13C (‰) Kuder et al, 2012	EDB δ	NS	--	--	-7.2±2‰	--	--	NS	--	--	NS	--	--
VOCs (µg/L) EPA Method 8260	1,1,2-TRICHLOROETHANE	ND	U	50	ND	U	25	ND	U	50	ND	U	50
	1,2,4-TRICHLOROBENZENE	NS	--	--	NS	--	--	NS	--	--	NS	--	--
	1,2,4-TRIMETHYLBENZENE	169		50	161		25	257		50	325		50
	1,2-DIBROMOETHANE	ND	U	50	21.9	J	25	51.7	J	50	51	J	50
	1,2-DICHLOROETHANE	ND	U	50	ND	U	25	ND	U	50	ND	U	50
	1,3,5-TRIMETHYLBENZENE	60.2	J	50	59.1		25	92.9	J	50	114		50
	2-BUTANONE	ND	U	500	ND	U	250	ND	U	500	ND	U	500
	2-CHLOROTOLUENE	ND	U	50	ND	U	25	ND	U	50	ND	U	50
	2-HEXANONE	ND	U	250	120	J	125	125	J	250	ND	U	250
	4-METHYL-2-PENTANONE	ND	U	250	75.5	J	125	ND	U	250	ND	U	250
	ACETONE	407	J-	500	375	J	250	493	J	500	356	J	500
	BENZENE	1950		50	2080		25	3750		50	3940		50
	CARBON DISULFIDE	ND	U	50	ND	U	25	ND	U	50	ND	U	50
	CHLOROMETHANE	ND	U	50	ND	U	25	47.9		50	ND	U	50
	CIS-1,2-DICHLOROETHENE	NA	--	--	NA	--	--	NA	--	--	NA	--	--
	DICHLORODIFLUOROMETHANE	ND	U	100	ND	U	50	ND	U	100	ND	U	100
	ETHYLBENZENE	437		50	477		25	815		50	919		50
	ISOPROPYLBENZENE	40.2	J	50	49	J	25	63.4	J	50	71.2	J	50
	M,P-XYLENES	NA	--	--	NA	--	--	NA	--	--	NA	--	--
	METHYL TERT-BUTYL ETHER	ND	U	50	ND	U	25	ND	U	50	ND	U	50
	METHYLENE CHLORIDE	ND	U	100	ND	U	50	57.4	J	100	ND	U	100
	NAPHTHALENE	64.5	J	50	63.1		25	80.9		50	98.7	J	50
	N-BUTYLBENZENE	ND	U	50	ND	U	25	ND	U	50	ND	U	50
	N-PROPYLBENZENE	45.1	J	50	49.6	J	25	70.2	J	50	84.6	J	50
	O-XYLENE	NA	--	--	NA	--	--	NA	--	--	NA	--	--
	P-ISOPROPYLTOLUENE	ND	U	50	19.3	J	25	29	J	50	36.9	J	50
	SEC-BUTYLBENZENE	ND	U	50	ND	U	25	ND	U	50	ND	U	50
	TERT-BUTYLBENZENE	ND	U	50	ND	U	25	ND	U	50	ND	U	50
	TETRACHLOROETHENE	NA	--	--	NA	--	--	NA	--	--	NA	--	--
	TOLUENE	4230		50	4420		25	8190		50	9220		50
	TRANS-1,2-DICHLOROETHENE	NA	--	--	NA	--	--	NA	--	--	NA	--	--
TRICHLOROETHENE	ND	U	50	ND	U	25	ND	U	50	ND	U	50	
TRICHLOROFUOROMETHANE	ND	U	100	ND	U	50	ND	U	100	ND	U	100	
VINYL CHLORIDE	NA	--	--	NA	--	--	NA	--	--	NA	--	--	
XYLENES	1490		150	1690		75	2760		150	2860		150	

Refer to notes at the end of the table.

Table 9
Analytical Data Table for KAFB-106EX1

Phase Designation		Phase 2 Recirculation						Phase 2 Passive					
Sample ID		106EX1-P2R-011618-FD			106EX1-P2R-012518			106EX1-P2P-030718			106EX1-P2P-041118		
Sample Date		1/16/2018			1/25/2018			3/7/2018			4/11/2018		
Sample Purpose		FD			REG			REG			REG		
Chemical Class and Analytical Method ^a	Parameter	Result	Val Qual	LOQ	Result	Val Qual	LOQ	Result	Val Qual	LOQ	Result	Val Qual	LOQ
Microbial Community (cells/mL) QuantArray-Chlor	1,1 DCA Reductase (DCA)	NS	--	--	ND	U	7.5	NS	--	--	NS	--	--
	1,2 DCA Reductase (DCAR)	NS	--	--	ND	U	7.5	NS	--	--	NS	--	--
	BAV1 Vinyl Chloride Reductase (BVC)	NS	--	--	ND	U	0.7	NS	--	--	NS	--	--
	cer A Reductase	NS	--	--	ND	U	7.5	NS	--	--	NS	--	--
	Chloroform Reductase (CFR)	NS	--	--	ND	U	7.5	NS	--	--	NS	--	--
	Dehalobacter DCM (DCM)	NS	--	--	ND	U	7.5	NS	--	--	NS	--	--
	Dehalobacter spp. (DHBt)	NS	--	--	118000		7.5	NS	--	--	NS	--	--
	Dehalobium chlorocoercia (DECO)	NS	--	--	15700		7.5	NS	--	--	NS	--	--
	Dehalococcoides (DHC)	NS	--	--	ND	U	0.7	NS	--	--	NS	--	--
	Dehalogenimonas spp. (DHG)	NS	--	--	ND	U	7.5	NS	--	--	NS	--	--
	Desulfitobacterium spp. (DSB)	NS	--	--	161000		7.5	NS	--	--	NS	--	--
	Desulfuromonas spp. (DSM)	NS	--	--	14.7		7.5	NS	--	--	NS	--	--
	Dichloromethane Dehalogenase (DCMA)	NS	--	--	ND	U	7.5	NS	--	--	NS	--	--
	Epoxyalkane Transferase (EtnE)	NS	--	--	121		7.5	NS	--	--	NS	--	--
	Ethene Monooxygenase (EtnC)	NS	--	--	ND	U	7.5	NS	--	--	NS	--	--
	Methanogens (MGN)	NS	--	--	4	J	7.5	NS	--	--	NS	--	--
	PCE Reductase (PCE-1)	NS	--	--	0.4	J	7.5	NS	--	--	NS	--	--
	Phenol Hydroxylase (PHE)	NS	--	--	100000		7.5	NS	--	--	NS	--	--
	PMMO	NS	--	--	NA	--	--	NS	--	--	NS	--	--
	Soluble Methane Monooxygenase (SMMO)	NS	--	--	639		7.5	NS	--	--	NS	--	--
	Sulfate Reducing Bacteria (APS)	NS	--	--	111000		7.5	NS	--	--	NS	--	--
	tceA Reductase (TCE)	NS	--	--	ND	U	0.7	NS	--	--	NS	--	--
	Toluene Dioxygenase (TOD)	NS	--	--	ND	U	7.5	NS	--	--	NS	--	--
	Toluene Monooxygenase (RMO)	NS	--	--	115000		7.5	NS	--	--	NS	--	--
Toluene Monooxygenase 2 (RDEG)	NS	--	--	35500		7.5	NS	--	--	NS	--	--	
Total Eubacteria (EBAC)	NS	--	--	17500000		7.5	NS	--	--	NS	--	--	
trans-1,2-DCE Reductase (TDR)	NS	--	--	ND	U	7.5	NS	--	--	NS	--	--	
Trichlorobenzene Dioxygenase (TCBO)	NS	--	--	210		7.5	NS	--	--	NS	--	--	
Vinyl Chloride Reductase (VCR)	NS	--	--	ND	U	0.7	NS	--	--	NS	--	--	
EDB (µg/L) EPA Method 8011	1,2-DIBROMOETHANE	80		1.91	69.7	J+	1.91	13.7	J+	1.91	3.74	J	1.92
VFAs (mg/L) EPA Method 300m	ACETIC ACID	5.75		1	20.2		1	38		1	32.4		1
	BUTYRIC ACID	ND	U	1	ND	U	1	0.6	J	1	ND	U	1
	FORMIC ACID	ND	U	1	ND	U	1	ND	U	1	ND	U	1
	LACTIC ACID	0.93	J	1	1.4		1	1.1		1	0.63	J	1
	PROPIONIC ACID	0.73	J	1	2.58		1	7		1	4.54		1
	PYRUVIC ACID	ND	U	1	ND	U	1	ND	U	1	ND	U	1
	VALERIC ACID	ND	U	1	ND	U	1	ND	U	1	ND	U	1
Fluorometric (µg/L) Spectrofluorophotometry	FLUORESC EIN	NS	--	--	NS	--	--	NS	--	--	NS	--	--
Reduced Gases (µg/L) RSKSOP-175	ACETYLENE	ND	U	10	ND	U	10	ND	U	10	ND	U	10
	ETHANE	2.71	J	4	2.36	J	4	2.4	J	4	2.17	J	4
	ETHYLENE	7.83		5	9.04		5	9		5	7.28		5
	METHANE	2.78		2	3.51		2	22.9		2	63.2		2
	PROPANE	2.61	J	6	3.04	J	6	3.4	J	6	3.42	J	6
General Chemistry (mg/L) SM2320b, EPA Method 300, EPA Method 353.2, SM4500 Pe ^c	ALKALINITY	294		1	291		1	331		1	337		1
	BROMIDE	0.383	J	0.25	0.363		0.125	0.404	J	0.25	0.441		0.125
	CHLORIDE	29.1		0.66	26.6		0.33	34.2		0.66	38.1		0.33
	IODIDE	0.59	J	0.75	1.3		0.75	3.3		0.75	3.9		0.75
	NITRATE	NA	--	--	NA	--	--	NA	--	--	ND	U	0.1
	NITRITE	NA	--	--	NA	--	--	NA	--	--	ND	U	0.1
	NITROGEN, NITRATE-NITRITE	ND	U	0.375	ND	U	0.375	ND	U	0.375	NA	--	--
	O-PHOSPHATE (AS P)	ND	U	0.02	0.0354	J	0.02	0.0116	J	0.02	0.0256		0.02
	ORTHOPHOSPHATE	NA	--	--	NA	--	--	NA	--	--	NA	--	--
	PHOSPHORUS	NA	--	--	NA	--	--	NA	--	--	NA	--	--
SULFATE	7.15		2	7.03		1	3.89	J	2	3.48		1	

Table 9
Analytical Data Table for KAFB-106EX1

Phase Designation		Phase 2 Recirculation						Phase 2 Passive					
Sample ID		106EX1-P2R-011618-FD			106EX1-P2R-012518			106EX1-P2P-030718			106EX1-P2P-041118		
Sample Date		1/16/2018			1/25/2018			3/7/2018			4/11/2018		
Sample Purpose		FD			REG			REG			REG		
Chemical Class and Analytical Method ^a	Parameter	Result	Val Qual	LOQ	Result	Val Qual	LOQ	Result	Val Qual	LOQ	Result	Val Qual	LOQ
Metals (mg/L) EPA Method 6010	LEAD	NS	--	--	NS	--	--	NS	--	--	NS	--	--
Dissolved Metals (mg/L) EPA Method 6010	IRON	0.518		0.06	0.548	J-	0.06	2.85		0.06	2.47	J-	0.06
	MANGANESE	2.46		0.006	2.39	J-	0.006	3.19		0.006	3.45	J+	0.006
δ ² H (‰) Mass Spectrometry, USGS Reston, VA	DELTA2H	NS	--	--	NS	--	--	NS	--	--	NS	--	--
CSIA EDB δ ¹³ C (‰) Kuder et al, 2012	EDB δ	NS	--	--	-9.7 ±2‰	--	--	NS	--	--	NS	--	--
VOCs (µg/L) EPA Method 8260	1,1,2-TRICHLOROETHANE	ND	U	50	ND	U	50	ND	U	50	ND	U	50
	1,2,4-TRICHLOROBENZENE	NS	--	--	NS	--	--	NS	--	--	NS	--	--
	1,2,4-TRIMETHYLBENZENE	300		50	345		50	270		50	281		50
	1,2-DIBROMOETHANE	45.8	J	50	45.4	J	50	ND	U	50	ND	U	50
	1,2-DICHLOROETHANE	ND	U	50	ND	U	50	ND	U	50	ND	U	50
	1,3,5-TRIMETHYLBENZENE	104		50	118		50	94.4	J	50	98.3	J	50
	2-BUTANONE	ND	U	500	ND	U	500	ND	U	500	ND	U	500
	2-CHLOROTOLUENE	ND	U	50	ND	U	50	ND	U	50	ND	U	50
	2-HEXANONE	ND	U	250	ND	U	250	ND	U	250	ND	U	250
	4-METHYL-2-PENTANONE	ND	U	250	ND	U	250	ND	U	250	ND	U	250
	ACETONE	356	J	500	ND	U	500	ND	U	500	ND	U	500
	BENZENE	3740		50	3950		50	3110		50	2490		50
	CARBON DISULFIDE	ND	U	50	ND	U	50	ND	U	50	ND	U	50
	CHLOROMETHANE	ND	U	50	ND	U	50	ND	U	50	ND	U	50
	CIS-1,2-DICHLOROETHENE	NA	--	--	NA	--	--	NA	--	--	NA	--	--
	DICHLORODIFLUOROMETHANE	ND	U	100	ND	U	100	ND	U	100	ND	U	100
	ETHYLBENZENE	842		50	963		50	811		50	786		50
	ISOPROPYLBENZENE	59.9	J	50	76.1	J	50	99.9	J	50	122		50
	M,P-XYLENES	NA	--	--	NA	--	--	NA	--	--	NA	--	--
	METHYL TERT-BUTYL ETHER	ND	U	50	ND	U	50	ND	U	50	ND	U	50
	METHYLENE CHLORIDE	ND	U	100	ND	U	100	ND	U	100	ND	U	100
	NAPHTHALENE	86.5	J	50	102		50	69.6	J	50	96.3	J	50
	N-BUTYLBENZENE	ND	U	50	ND	U	50	ND	U	50	ND	U	50
	N-PROPYLBENZENE	74.5	J	50	87	J	50	67.3	J	50	75.8	J	50
	O-XYLENE	NA	--	--	NA	--	--	NA	--	--	NA	--	--
	P-ISOPROPYLTOLUENE	30.9	J	50	ND	U	50	ND	U	50	44.9	J	50
	SEC-BUTYLBENZENE	ND	U	50	ND	U	50	ND	U	50	ND	U	50
	TERT-BUTYLBENZENE	ND	U	50	ND	U	50	ND	U	50	ND	U	50
	TETRACHLOROETHENE	NA	--	--	NA	--	--	NA	--	--	NA	--	--
	TOLUENE	8610		50	9550		50	7660		50	6280		50
	TRANS-1,2-DICHLOROETHENE	NA	--	--	NA	--	--	NA	--	--	NA	--	--
TRICHLOROETHENE	ND	U	50	ND	U	50	ND	U	50	ND	U	50	
TRICHLOROFUOROMETHANE	ND	U	100	ND	U	100	ND	U	100	ND	U	100	
VINYL CHLORIDE	NA	--	--	NA	--	--	NA	--	--	NA	--	--	
XYLENES	2640		150	3190		150	2430		150	2180		150	

Refer to notes at the end of the table.

Table 9
Analytical Data Table for KAFB-106EX1

Phase Designation		Phase 2 Passive						Phase 3 Recirculation					
Sample ID		106EX1-P2P-050918			106EX1-P2P-061418			106EX1-P3R-080818			106EX1-P3R-081618		
Sample Date		5/9/2018			6/14/2018			8/8/2018			8/16/2018		
Sample Purpose		REG			REG			REG			REG		
Chemical Class and Analytical Method ^a	Parameter	Result	Val Qual	LOQ	Result	Val Qual	LOQ	Result	Val Qual	LOQ	Result	Val Qual	LOQ
Microbial Community (cells/mL) QuantArray-Chlor	1,1 DCA Reductase (DCA)	ND	U	7.9	NS	--	--	NS	--	--	NS	--	--
	1,2 DCA Reductase (DCAR)	ND	U	7.9	NS	--	--	NS	--	--	NS	--	--
	BAV1 Vinyl Chloride Reductase (BVC)	ND	U	0.8	NS	--	--	NS	--	--	NS	--	--
	cer A Reductase	ND	U	7.9	NS	--	--	NS	--	--	NS	--	--
	Chloroform Reductase (CFR)	ND	U	7.9	NS	--	--	NS	--	--	NS	--	--
	Dehalobacter DCM (DCM)	864		7.9	NS	--	--	NS	--	--	NS	--	--
	Dehalobacter spp. (DHBt)	228000		7.9	NS	--	--	NS	--	--	NS	--	--
	Dehalobium chlorocoercia (DECO)	46800		7.9	NS	--	--	NS	--	--	NS	--	--
	Dehalococcoides (DHC)	ND	U	0.8	NS	--	--	NS	--	--	NS	--	--
	Dehalogenimonas spp. (DHG)	3470		7.9	NS	--	--	NS	--	--	NS	--	--
	Desulfitobacterium spp. (DSB)	74400		7.9	NS	--	--	NS	--	--	NS	--	--
	Desulfuromonas spp. (DSM)	3800		7.9	NS	--	--	NS	--	--	NS	--	--
	Dichloromethane Dehalogenase (DCMA)	ND	U	7.9	NS	--	--	NS	--	--	NS	--	--
	Epoxyalkane Transferase (EtnE)	222		7.9	NS	--	--	NS	--	--	NS	--	--
	Ethene Monooxygenase (EtnC)	ND	U	7.9	NS	--	--	NS	--	--	NS	--	--
	Methanogens (MGN)	98.9		7.9	NS	--	--	NS	--	--	NS	--	--
	PCE Reductase (PCE-1)	ND	U	7.9	NS	--	--	NS	--	--	NS	--	--
	Phenol Hydroxylase (PHE)	119000		7.9	NS	--	--	NS	--	--	NS	--	--
	PMMO	NA	--	--	NS	--	--	NS	--	--	NS	--	--
	Soluble Methane Monooxygenase (SMMO)	300		7.9	NS	--	--	NS	--	--	NS	--	--
	Sulfate Reducing Bacteria (APS)	116000		7.9	NS	--	--	NS	--	--	NS	--	--
	tceA Reductase (TCE)	ND	U	0.8	NS	--	--	NS	--	--	NS	--	--
	Toluene Dioxygenase (TOD)	ND	U	7.9	NS	--	--	NS	--	--	NS	--	--
	Toluene Monooxygenase (RMO)	138000		7.9	NS	--	--	NS	--	--	NS	--	--
Toluene Monooxygenase 2 (RDEG)	62700		7.9	NS	--	--	NS	--	--	NS	--	--	
Total Eubacteria (EBAC)	14700000		7.9	NS	--	--	NS	--	--	NS	--	--	
trans-1,2-DCE Reductase (TDR)	ND	U	7.9	NS	--	--	NS	--	--	NS	--	--	
Trichlorobenzene Dioxygenase (TCBO)	ND	U	7.9	NS	--	--	NS	--	--	NS	--	--	
Vinyl Chloride Reductase (VCR)	ND	U	0.8	NS	--	--	NS	--	--	NS	--	--	
EDB (µg/L) EPA Method 8011	1,2-DIBROMOETHANE	2.8		0.0939	2.43		0.192	17		0.31	19		0.3
VFAs (mg/L) EPA Method 300m	ACETIC ACID	41		1	64.9	J	10	30.6		10	28.5		10
	BUTYRIC ACID	ND	U	1	ND	UJ	10	ND	U	1	ND	U	1
	FORMIC ACID	ND	U	1	ND	UJ	10	ND	U	1	ND	U	1
	LACTIC ACID	0.76	J	1	ND	UJ	10	0.3	J	1	0.7	J	1
	PROPIONIC ACID	5.38		1	ND	UJ	10	3.5	J	10	ND	U	1
	PYRUVIC ACID	ND	U	1	ND	UJ	10	ND	U	1	ND	U	1
	VALERIC ACID	ND	U	1	ND	UJ	10	ND	U	1	ND	U	1
Fluorometric (µg/L) Spectrofluorophotometry	FLUORESC EIN	NS	--	--	NS	--	--	NS	--	--	NS	--	--
Reduced Gases (µg/L) RSKSOP-175	ACETYLENE	ND	U	10	ND	UJ	10	ND	U	10	ND	U	10
	ETHANE	3.18	J	4	4.3	J	4	3.3	J	4	3.8	J	4
	ETHYLENE	11.4		5	13.2	J	5	11.9		5	13		5
	METHANE	103		2	256	J	2	7.9		2	9.3		2
	PROPANE	4.9	J	6	5.6	J	6	7.1		6	5.5	J	6
General Chemistry (mg/L) SM2320b, EPA Method 300, EPA Method 353.2, SM4500 Pe ^c	ALKALINITY	349		1	408	J-	1	310		5	320		5
	BROMIDE	0.512		0.125	0.496	J	0.25	1		1	0.71		0.5
	CHLORIDE	43.2		0.33	45.7		0.66	33		1	33		0.5
	IODIDE	6.8		0.75	8.3		0.75	4.2		0.75	3.9		0.75
	NITRATE	ND	U	0.1	ND	U	0.2	NA	--	--	NA	--	--
	NITRITE	ND	U	0.1	ND	U	0.2	NA	--	--	NA	--	--
	NITROGEN, NITRATE-NITRITE	NA	--	--	NA	--	--	ND	R	0.05	ND	U	0.05
	O-PHOSPHATE (AS P)	0.0364	J	0.02	0.0185		0.02	NA	--	--	NA	--	--
	ORTHOPHOSPHATE	NA	--	--	NA	--	--	ND	R	0.15	ND	U	0.15
	PHOSPHORUS	NA	--	--	NA	--	--	NA	--	--	NA	--	--
SULFATE	3.6		1	0.774	J	2	8.4		2	6.7		1	

Table 9
Analytical Data Table for KAFB-106EX1

Phase Designation		Phase 2 Passive						Phase 3 Recirculation					
Sample ID		106EX1-P2P-050918			106EX1-P2P-061418			106EX1-P3R-080818			106EX1-P3R-081618		
Sample Date		5/9/2018			6/14/2018			8/8/2018			8/16/2018		
Sample Purpose		REG			REG			REG			REG		
Chemical Class and Analytical Method ^a	Parameter	Result	Val Qual	LOQ	Result	Val Qual	LOQ	Result	Val Qual	LOQ	Result	Val Qual	LOQ
Metals (mg/L) EPA Method 6010	LEAD	NS	--	--	NS	--	--	NS	--	--	NS	--	--
Dissolved Metals (mg/L) EPA Method 6010	IRON	2.59		0.06	4.58		0.06	1.5		0.05	1.5		0.05
	MANGANESE	3.97		0.006	5.03		0.006	4		0.003	4.2		0.003
δ2H (‰) Mass Spectrometry, USGS Reston, VA	DELTA2H	NS	--	--	NS	--	--	NS	--	--	NS	--	--
CSIA EDB δ13C (‰) Kuder et al, 2012	EDB δ	6.0 ±1.5‰	--	--	NS	--	--	NS	--	--	NS	--	--
VOCs (µg/L) EPA Method 8260	1,1,2-TRICHLOROETHANE	ND	U	50	ND	U	50	ND	U	0.5	ND	U	10
	1,2,4-TRICHLOROBENZENE	NS	--	--	NS	--	--	NS	--	--	NS	--	--
	1,2,4-TRIMETHYLBENZENE	296		50	334		50	250		20	320		20
	1,2-DIBROMOETHANE	ND	U	50	ND	U	50	19	J+	1	19	J	20
	1,2-DICHLOROETHANE	ND	U	50	ND	U	50	ND	U	1	ND	U	20
	1,3,5-TRIMETHYLBENZENE	104		50	114		50	100	J+	0.5	110		10
	2-BUTANONE	ND	U	500	ND	U	500	67	J+	10	81	J	200
	2-CHLOROTOLUENE	ND	U	50	ND	U	50	ND	U	0.5	ND	U	10
	2-HEXANONE	ND	U	250	ND	U	250	83	J+	5	88	J	100
	4-METHYL-2-PENTANONE	ND	U	250	ND	U	250	67	J+	5	66	J	100
	ACETONE	ND	U	500	408	J	500	230	J+	10	280		200
	BENZENE	3410		50	4360		50	2900		20	3500		20
	CARBON DISULFIDE	ND	U	50	ND	U	50	ND	U	2	ND	U	40
	CHLOROMETHANE	ND	U	50	ND	U	50	ND	U	1	ND	U	20
	CIS-1,2-DICHLOROETHENE	NA	--	--	NA	--	--	NA	--	--	NA	--	--
	DICHLORODIFLUOROMETHANE	ND	U	100	ND	U	100	ND	U	1	ND	U	20
	ETHYLBENZENE	866		50	1090		50	760		20	890		20
	ISOPROPYLBENZENE	125		50	167		50	74	J+	1	79		20
	M,P-XYLENES	NA	--	--	NA	--	--	NA	--	--	NA	--	--
	METHYL TERT-BUTYL ETHER	ND	U	50	ND	U	50	ND	U	0.5	ND	U	10
	METHYLENE CHLORIDE	ND	U	100	55.4	J	100	ND	U	5	ND	U	100
	NAPHTHALENE	113		50	114		50	120	J+	5	130		100
	N-BUTYLBENZENE	ND	U	50	ND	U	50	14	J+	1	14	J	20
	N-PROPYLBENZENE	83.6	J	50	92.6	J	50	71	J+	1	76		20
	O-XYLENE	NA	--	--	NA	--	--	NA	--	--	NA	--	--
	P-ISOPROPYLTOLUENE	54.8	J	50	ND	U	50	51	J+	1	49		20
	SEC-BUTYLBENZENE	ND	U	50	ND	U	50	14	J+	1	15	J	20
	TERT-BUTYLBENZENE	ND	U	50	ND	U	50	ND	U	1	ND	U	20
	TETRACHLOROETHENE	NA	--	--	NA	--	--	NA	--	--	NA	--	--
	TOLUENE	7660		50	10100		50	8300	J-	100	9500		100
TRANS-1,2-DICHLOROETHENE	NA	--	--	NA	--	--	NA	--	--	NA	--	--	
TRICHLOROETHENE	ND	U	50	ND	U	50	ND	U	1	ND	U	20	
TRICHLOROFUOROMETHANE	ND	U	100	ND	U	100	ND	U	1	ND	U	20	
VINYL CHLORIDE	NA	--	--	NA	--	--	NA	--	--	NA	--	--	
XYLENES	2680		150	3480		150	2400		10	2900		10	

Refer to notes at the end of the table.

Table 9
Analytical Data Table for KAFB-106EX1

Phase Designation		Phase 3 Recirculation									Phase 3 Passive		
Sample ID		106EX1-P3R-081618-FD			106EX1-P3R-082218			106EX1-P3R-082918			106EX1-P3P-091218		
Sample Date		8/16/2018			8/22/2018			8/29/2018			9/12/2018		
Sample Purpose		FD			REG			REG			REG		
Chemical Class and Analytical Method ^a	Parameter	Result	Val Qual	LOQ	Result	Val Qual	LOQ	Result	Val Qual	LOQ	Result	Val Qual	LOQ
Microbial Community (cells/mL) QuantArray-Chlor	1,1 DCA Reductase (DCA)	NS	--	--	ND	U	5	NS	--	--	NS	--	--
	1,2 DCA Reductase (DCAR)	NS	--	--	ND	U	5	NS	--	--	NS	--	--
	BAV1 Vinyl Chloride Reductase (BVC)	NS	--	--	ND	U	0.5	NS	--	--	NS	--	--
	cer A Reductase	NS	--	--	ND	U	5	NS	--	--	NS	--	--
	Chloroform Reductase (CFR)	NS	--	--	ND	U	5	NS	--	--	NS	--	--
	Dehalobacter DCM (DCM)	NS	--	--	963		5	NS	--	--	NS	--	--
	Dehalobacter spp. (DHBt)	NS	--	--	192000		5	NS	--	--	NS	--	--
	Dehalobium chlorocoercia (DECO)	NS	--	--	11100		5	NS	--	--	NS	--	--
	Dehalococcoides (DHC)	NS	--	--	1.4		0.5	NS	--	--	NS	--	--
	Dehalogenimonas spp. (DHG)	NS	--	--	ND	U	5	NS	--	--	NS	--	--
	Desulfitobacterium spp. (DSB)	NS	--	--	113000		5	NS	--	--	NS	--	--
	Desulfuromonas spp. (DSM)	NS	--	--	ND	U	5	NS	--	--	NS	--	--
	Dichloromethane Dehalogenase (DCMA)	NS	--	--	ND	U	5	NS	--	--	NS	--	--
	Epoxyalkane Transferase (EtnE)	NS	--	--	367		5	NS	--	--	NS	--	--
	Ethene Monooxygenase (EtnC)	NS	--	--	ND	U	5	NS	--	--	NS	--	--
	Methanogens (MGN)	NS	--	--	87.9		5	NS	--	--	NS	--	--
	PCE Reductase (PCE-1)	NS	--	--	ND	U	5	NS	--	--	NS	--	--
	Phenol Hydroxylase (PHE)	NS	--	--	67000		5	NS	--	--	NS	--	--
	PMMO	NS	--	--	NA	--	--	NS	--	--	NS	--	--
	Soluble Methane Monooxygenase (SMMO)	NS	--	--	183		5	NS	--	--	NS	--	--
	Sulfate Reducing Bacteria (APS)	NS	--	--	198000		5	NS	--	--	NS	--	--
	tceA Reductase (TCE)	NS	--	--	ND	U	0.5	NS	--	--	NS	--	--
	Toluene Dioxygenase (TOD)	NS	--	--	ND	U	5	NS	--	--	NS	--	--
	Toluene Monooxygenase (RMO)	NS	--	--	278000		5	NS	--	--	NS	--	--
Toluene Monooxygenase 2 (RDEG)	NS	--	--	22000		5	NS	--	--	NS	--	--	
Total Eubacteria (EBAC)	NS	--	--	13800000		5	NS	--	--	NS	--	--	
trans-1,2-DCE Reductase (TDR)	NS	--	--	ND	U	5	NS	--	--	NS	--	--	
Trichlorobenzene Dioxygenase (TCBO)	NS	--	--	ND	U	5	NS	--	--	NS	--	--	
Vinyl Chloride Reductase (VCR)	NS	--	--	ND	U	0.5	NS	--	--	NS	--	--	
EDB (µg/L) EPA Method 8011	1,2-DIBROMOETHANE	22		0.061	11		0.0003	20		0.059	9.3		0.03
VFAs (mg/L) EPA Method 300m	ACETIC ACID	28.6		10	34.3		10	35.2		10	51.6		10
	BUTYRIC ACID	ND	U	1	ND	U	1	ND	U	1	ND	U	1
	FORMIC ACID	ND	U	1	ND	U	1	ND	U	1	ND	U	1
	LACTIC ACID	0.9	J	1	0.6	J	1	0.6	J	1	0.8	J	1
	PROPIONIC ACID	ND	U	1	ND	U	1	4.4		1	11.6		1
	PYRUVIC ACID	ND	U	1	ND	U	1	ND	U	1	ND	U	1
	VALERIC ACID	ND	U	1	ND	U	1	ND	U	1	ND	U	1
Fluorometric (µg/L) Spectrofluorophotometry	FLUORESC EIN	NS	--	--	NS	--	--	NS	--	--	NS	--	--
Reduced Gases (µg/L) RSKSOP-175	ACETYLENE	ND	U	10	ND	U	10	ND	U	10	ND	U	10
	ETHANE	3.6	J	4	3.5	J	4	3.4	J	4	3.8	J	4
	ETHYLENE	12.3		5	11.5		5	10.9		5	11.8		5
	METHANE	9		2	9.4		2	11.6		2	112.7		2
	PROPANE	4.8	J	6	4.8	J	6	4.5	J	6	4.7	J	6
General Chemistry (mg/L) SM2320b, EPA Method 300, EPA Method 353.2, SM4500 Pe ^c	ALKALINITY	330		5	340		5	340		5	360		5
	BROMIDE	0.69		0.5	0.68		0.5	0.72		0.5	0.71		0.5
	CHLORIDE	33		0.5	34		0.5	37		0.5	37		0.5
	IODIDE	3.7		0.75	4.1		0.75	4.6		0.75	4.7		0.75
	NITRATE	NA	--	--	NA	--	--	NA	--	--	NA	--	--
	NITRITE	NA	--	--	NA	--	--	NA	--	--	NA	--	--
	NITROGEN, NITRATE-NITRITE	ND	U	0.05	ND		0.05	ND	U	0.05	ND	U	0.05
	O-PHOSPHATE (AS P)	NA	--	--	NA	--	--	NA	--	--	NA	--	--
	ORTHOPHOSPHATE	ND	U	0.15	ND		0.15	ND	U	0.15	ND	U	0.15
	PHOSPHORUS	NA	--	--	NA	--	--	NA	--	--	NA	--	--
SULFATE	6.7		1	6.6		1	6.9		1	2.7		1	

Table 9
Analytical Data Table for KAFB-106EX1

Phase Designation		Phase 3 Recirculation									Phase 3 Passive		
Sample ID		106EX1-P3R-081618-FD			106EX1-P3R-082218			106EX1-P3R-082918			106EX1-P3P-091218		
Sample Date		8/16/2018			8/22/2018			8/29/2018			9/12/2018		
Sample Purpose		FD			REG			REG			REG		
Chemical Class and Analytical Method ^a	Parameter	Result	Val Qual	LOQ	Result	Val Qual	LOQ	Result	Val Qual	LOQ	Result	Val Qual	LOQ
Metals (mg/L) EPA Method 6010	LEAD	NS	--	--	NS	--	--	NS	--	--	NS	--	--
Dissolved Metals (mg/L) EPA Method 6010	IRON	1.5		0.05	1.3		0.05	1.3		0.05	2.8		0.05
	MANGANESE	4.2		0.003	3.8		0.003	4.1		0.003	4.6		0.003
δ2H (‰) Mass Spectrometry, USGS Reston, VA	DELTA2H	NS	--	--	NS	--	--	NS	--	--	NS	--	--
CSIA EDB δ13C (‰) Kuder et al, 2012	EDB δ	NS	--	--	8.0 ±1.5‰	--	--	NS	--	--	-3.4 ±1.5‰	--	--
VOCs (µg/L) EPA Method 8260	1,1,2-TRICHLOROETHANE	ND	U	10	ND	U	50	ND	U	0.5	ND	U	50
	1,2,4-TRICHLOROBENZENE	NS	--	--	NS	--	--	NS	--	--	NS	--	--
	1,2,4-TRIMETHYLBENZENE	300		20	340		100	260		100	300		100
	1,2-DIBROMOETHANE	20		20	ND	U	100	19	J+	1	ND	U	100
	1,2-DICHLOROETHANE	ND	U	20	ND	U	100	2.8		1	ND	U	100
	1,3,5-TRIMETHYLBENZENE	100		10	120		50	99	J+	0.5	110		50
	2-BUTANONE	73	J	200	ND	U	1000	72	J+	10	ND	U	1000
	2-CHLOROTOLUENE	ND	U	10	ND	U	50	ND	U	0.5	ND	U	50
	2-HEXANONE	92	J	100	ND	U	500	75	J+	5	ND	U	500
	4-METHYL-2-PENTANONE	70	J	100	ND	U	500	61	J+	5	ND	U	500
	ACETONE	280		200	ND	U	1000	250	J+	10	ND	U	1000
	BENZENE	3300		20	3800		100	3200		100	3600		100
	CARBON DISULFIDE	ND	U	40	ND	U	200	ND	U	2	ND	U	200
	CHLOROMETHANE	ND	U	20	ND	U	100	ND	U	1	ND	U	100
	CIS-1,2-DICHLOROETHENE	NA	--	--	NA	--	--	NA	--	--	NA	--	--
	DICHLORODIFLUOROMETHANE	ND	U	20	ND	U	100	ND	U	1	ND	U	100
	ETHYLBENZENE	830		20	1000		100	790		100	970		100
	ISOPROPYLBENZENE	71		20	88	J	100	77	J+	1	110		100
	M,P-XYLENES	NA	--	--	NA	--	--	NA	--	--	NA	--	--
	METHYL TERT-BUTYL ETHER	ND	U	10	ND	U	50	ND	U	0.5	ND	U	50
	METHYLENE CHLORIDE	ND	U	100	ND	U	500	ND	U	5	ND	U	500
	NAPHTHALENE	120		100	ND	U	500	120	J+	5	ND	U	500
	N-BUTYLBENZENE	12	J	20	ND	U	100	15	J+	1	ND	U	100
	N-PROPYLBENZENE	68		20	87	J	100	73	J+	1	85	J	100
	O-XYLENE	NA	--	--	NA	--	--	NA	--	--	NA	--	--
	P-ISOPROPYLTOLUENE	44		20	53	J	100	59	J+	1	64	J	100
	SEC-BUTYLBENZENE	14	J	20	ND	U	100	13	J+	1	ND	U	100
	TERT-BUTYLBENZENE	ND	U	20	ND	U	100	1	J+	1	ND	U	100
	TETRACHLOROETHENE	NA	--	--	NA	--	--	NA	--	--	NA	--	--
	TOLUENE	9300		100	9800		100	7900		100	8700		100
	TRANS-1,2-DICHLOROETHENE	NA	--	--	NA	--	--	NA	--	--	NA	--	--
TRICHLOROETHENE	ND	U	20	ND	U	100	ND	U	1	ND	U	100	
TRICHLOROFUOROMETHANE	ND	U	20	ND	U	100	ND	U	1	ND	U	100	
VINYL CHLORIDE	NA	--	--	NA	--	--	NA	--	--	NA	--	--	
XYLENES	2700		10	3200		50	2500		50	3000		50	

Refer to notes at the end of the table.

Table 9
Analytical Data Table for KAFB-106EX1

Phase Designation		Phase 3 Passive						Phase 4 Passive					
Sample ID		106EX1-P3P-100418			106EX1-P3P-111918			106EX1-P4P-012119			106EX1-LTM-031220		
Sample Date		10/4/2018			11/19/2018			1/21/2019			3/12/2020		
Sample Purpose		REG			REG			REG			REG		
Chemical Class and Analytical Method ^a	Parameter	Result	Val Qual	LOQ	Result	Val Qual	LOQ	Result	Val Qual	LOQ	Result	Val Qual	LOQ
Microbial Community (cells/mL) QuantArray-Chlor	1,1 DCA Reductase (DCA)	NS	--	--	ND	U	5.9	ND	U	5.2	ND	U	4.8
	1,2 DCA Reductase (DCAR)	NS	--	--	ND	U	5.9	ND	U	5.2	ND	U	4.8
	BAV1 Vinyl Chloride Reductase (BVC)	NS	--	--	ND	U	0.6	ND	U	0.5	ND	U	0.5
	cer A Reductase	NS	--	--	ND	U	5.9	ND	U	5.2	ND	U	4.8
	Chloroform Reductase (CFR)	NS	--	--	44.2		5.9	ND	U	5.2	ND	U	4.8
	Dehalobacter DCM (DCM)	NS	--	--	640		5.9	ND	U	5.2	ND	U	4.8
	Dehalobacter spp. (DHBt)	NS	--	--	211000		5.9	207000		5.2	47700		4.8
	Dehalobium chlorocoercia (DECO)	NS	--	--	5700		5.9	4970		5.2	1400		4.8
	Dehalococcoides (DHC)	NS	--	--	ND	U	0.6	0.3	J	0.5	1.5		0.5
	Dehalogenimonas spp. (DHG)	NS	--	--	200		5.9	ND	U	5.2	ND	U	4.8
	Desulfitobacterium spp. (DSB)	NS	--	--	67400		5.9	63300		5.2	21500		4.8
	Desulfuromonas spp. (DSM)	NS	--	--	ND	U	5.9	ND	U	5.2	7		4.8
	Dichloromethane Dehalogenase (DCMA)	NS	--	--	ND	U	5.9	ND	U	5.2	ND	U	4.8
	Epoxyalkane Transferase (EtnE)	NS	--	--	ND	U	5.9	ND	U	5.2	ND	U	4.8
	Ethene Monooxygenase (EtnC)	NS	--	--	ND	U	5.9	ND	U	5.2	ND	U	4.8
	Methanogens (MGN)	NS	--	--	9890		5.9	30000		5.2	3290		4.8
	PCE Reductase (PCE-1)	NS	--	--	ND	U	5.9	ND	U	5.2	ND	U	4.8
	Phenol Hydroxylase (PHE)	NS	--	--	14600		5.9	12700		5.2	16400		4.8
	PMMO	NS	--	--	NA	--	--	NA	--	--	NA	--	--
	Soluble Methane Monooxygenase (SMMO)	NS	--	--	ND	U	5.9	95.3		5.2	157		4.8
	Sulfate Reducing Bacteria (APS)	NS	--	--	217000		5.9	110000		5.2	55300		4.8
	tceA Reductase (TCE)	NS	--	--	ND	U	0.6	ND	U	0.5	ND	U	0.5
	Toluene Dioxygenase (TOD)	NS	--	--	ND	U	5.9	ND	U	5.2	ND	U	4.8
	Toluene Monooxygenase (RMO)	NS	--	--	30700		5.9	34000		5.2	21800		4.8
Toluene Monooxygenase 2 (RDEG)	NS	--	--	19800		5.9	8210		5.2	8110		4.8	
Total Eubacteria (EBAC)	NS	--	--	8370000		5.9	6200000		5.2	6190000		4.8	
trans-1,2-DCE Reductase (TDR)	NS	--	--	ND	U	5.9	ND	U	5.2	ND	U	4.8	
Trichlorobenzene Dioxygenase (TCBO)	NS	--	--	ND	U	5.9	ND	U	5.2	98		4.8	
Vinyl Chloride Reductase (VCR)	NS	--	--	ND	U	0.6	ND	U	0.5	ND	U	0.5	
EDB (µg/L) EPA Method 8011	1,2-DIBROMOETHANE	3		0.015	0.9		0.0059	0.78		0.003	0.59		0.021
VFAs (mg/L) EPA Method 300m	ACETIC ACID	102		10	37.8		10	19.1		10	2	J	10
	BUTYRIC ACID	ND	U	1	ND	U	1	ND	U	1	ND	U	1
	FORMIC ACID	ND	U	1	ND	U	1	ND	U	1	0.8	J	10
	LACTIC ACID	ND	U	1	0.6	J	1	0.5	J	1	1.4	J	10
	PROPIONIC ACID	17.5		10	ND	U	1	ND	U	1	ND	U	1
	PYRUVIC ACID	ND	U	1	ND	U	1	ND	U	1	ND	U	1
	VALERIC ACID	ND	U	1	ND	U	1	ND	U	1	ND	U	1
Fluorometric (µg/L) Spectrofluorophotometry	FLUORESC EIN	NS	--	--	NS	--	--	NS	--	--	NS	--	--
Reduced Gases (µg/L) RSKSOP-175	ACETYLENE	ND	U	10	ND	U	10	ND	U	10	ND	U	10
	ETHANE	4.4		4	3.6	J	4	1.9	J	4	ND	U	4
	ETHYLENE	13.5		5	9.5		5	5.2		5	1.1	J	5
	METHANE	1040.2		2	1724		2	2940.2		2	714.3		2
	PROPANE	11.2		6	5.7	J	6	ND	U	6	ND	U	6
General Chemistry (mg/L) SM2320b, EPA Method 300, EPA Method 353.2, SM4500 Pe ^c	ALKALINITY	440		5	420		5	420		5	580		5
	BROMIDE	2		0.5	1.1		0.5	0.84		0.5	0.827		0.1
	CHLORIDE	46		0.5	45		0.5	44		0.5	50.7		0.5
	IODIDE	6.2		0.75	6.2		0.75	7.3	J+	1.5	10		0.2
	NITRATE	NA	--	--	NA	--	--	NA	--	--	0.0551	J	0.1
	NITRITE	NA	--	--	NA	--	--	NA	--	--	NA	--	--
	NITROGEN, NITRATE-NITRITE	ND	U	0.05	ND	U	0.05	ND	UJ	0.05	ND	U	0.1
	O-PHOSPHATE (AS P)	NA	--	--	NA	--	--	NA	--	--	NA	--	--
	ORTHOPHOSPHATE	ND	U	0.15	ND	UJ	0.15	ND	UJ	0.15	NA	--	--
	PHOSPHORUS	NA	--	--	NA	--	--	NA	--	--	ND	U	0.025
	SULFATE	ND	U	1	0.54	J	1	0.51	J	1	ND	U	0.5

Table 9
Analytical Data Table for KAFB-106EX1

Phase Designation		Phase 3 Passive						Phase 4 Passive					
Sample ID		106EX1-P3P-100418			106EX1-P3P-111918			106EX1-P4P-012119			106EX1-LTM-031220		
Sample Date		10/4/2018			11/19/2018			1/21/2019			3/12/2020		
Sample Purpose		REG			REG			REG			REG		
Chemical Class and Analytical Method ^a	Parameter	Result	Val Qual	LOQ	Result	Val Qual	LOQ	Result	Val Qual	LOQ	Result	Val Qual	LOQ
Metals (mg/L) EPA Method 6010	LEAD	NS	--	--	NS	--	--	NS	--	--	ND	U	0.001
Dissolved Metals (mg/L) EPA Method 6010	IRON	7.7		0.05	7.5		0.05	8.4		0.05	8.88		0.05
	MANGANESE	6.8		0.003	5.7		0.003	4.8		0.003	4.55		0.05
δ2H (‰) Mass Spectrometry, USGS Reston, VA	DELTA2H	NS	--	--	NS	--	--	NS	--	--	NS	--	--
CSIA EDB δ13C (‰) Kuder et al, 2012	EDB δ	NS	--	--	NS	--	--	NS	--	--	NS	--	--
VOCs (µg/L) EPA Method 8260	1,1,2-TRICHLOROETHANE	ND	U	50	ND	U	25	ND	U	10	ND	U	2.5
	1,2,4-TRICHLOROBENZENE	NS	--	--	NS	--	--	NS	--	--	ND	U	2.5
	1,2,4-TRIMETHYLBENZENE	530		100	280		50	250		20	NA	--	--
	1,2-DIBROMOETHANE	ND	U	100	ND	U	50	ND	U	20	ND	U	2.5
	1,2-DICHLOROETHANE	ND	U	100	ND	U	50	NA	--	--	ND	U	2.5
	1,3,5-TRIMETHYLBENZENE	180		50	100		25	78		10	82		2.5
	2-BUTANONE	ND	U	1000	ND	U	500	ND	U	200	ND	U	5
	2-CHLOROTOLUENE	ND	U	50	ND	U	25	ND	U	10	ND	U	2.5
	2-HEXANONE	ND	U	500	ND	U	250	ND	U	100	ND	U	5
	4-METHYL-2-PENTANONE	ND	U	500	ND	U	250	47	J	100	ND	U	5
	ACETONE	ND	U	1000	ND	U	500	ND	U	200	ND	U	5
	BENZENE	4000		100	3000		50	2000		20	2300		25
	CARBON DISULFIDE	ND	U	200	ND	U	100	ND	U	40	ND	U	5
	CHLOROMETHANE	ND	U	100	ND	U	50	ND	U	20	ND	U	2.5
	CIS-1,2-DICHLOROETHENE	NA	--	--	NA	--	--	NA	--	--	ND	U	2.5
	DICHLORODIFLUOROMETHANE	ND	U	100	ND	U	50	NA	--	--	ND	U	2.5
	ETHYLBENZENE	1300		100	950		50	NA	--	--	560		2.5
	ISOPROPYLBENZENE	190		100	180		50	150		20	83		2.5
	M,P-XYLENES	NA	--	--	NA	--	--	NA	--	--	1100		5
	METHYL TERT-BUTYL ETHER	ND	U	50	ND	U	25	ND	U	10	ND	U	2.5
	METHYLENE CHLORIDE	ND	U	500	ND	U	250	ND	U	100	ND	U	5
	NAPHTHALENE	690		500	ND	U	250	90	J	100	64		2.5
	N-BUTYLBENZENE	ND	U	100	ND	U	50	13	J	20	13		2.5
	N-PROPYLBENZENE	150		100	84		50	63		20	45		2.5
	O-XYLENE	NA	--	--	NA	--	--	NA	--	--	640		2.5
	P-ISOPROPYLTOLUENE	110		100	56		50	56		20	ND	U	2.5
	SEC-BUTYLBENZENE	ND	U	100	ND	U	50	13	J	20	15		2.5
	TERT-BUTYLBENZENE	ND	U	100	ND	U	50	ND	U	20	ND	U	2.5
	TETRACHLOROETHENE	NA	--	--	NA	--	--	NA	--	--	ND	U	2.5
	TOLUENE	12000		100	8800		50	4500		50	240		2.5
TRANS-1,2-DICHLOROETHENE	NA	--	--	NA	--	--	NA	--	--	ND	U	2.5	
TRICHLOROETHENE	ND	U	100	ND	U	50	ND	U	20	ND	U	2.5	
TRICHLOROFUOROMETHANE	ND	U	100	ND	U	50	ND	U	20	ND	U	2.5	
VINYL CHLORIDE	NA	--	--	NA	--	--	NA	--	--	ND	U	2.5	
XYLENES	4100		50	3000		25	2100		10	1700		2.5	

Refer to notes at the end of the table.

Table 9
Analytical Data Table for KAFB-106EX1

Phase Designation		Phase 4 Passive								
Sample ID		106EX1-LTM-052020			106EX1-LTM-080420			106EX1-LTM-101520		
Sample Date		5/20/2020			8/4/2020			10/15/2020		
Sample Purpose		REG			REG			REG		
Chemical Class and Analytical Method ^a	Parameter	Result	Val Qual	LOQ	Result	Val Qual	LOQ	Result	Val Qual	LOQ
Microbial Community (cells/mL) QuantArray-Chlor	1,1 DCA Reductase (DCA)	ND	U	4.9	ND	U	4.7	5.9		5.9
	1,2 DCA Reductase (DCAR)	ND	U	4.9	ND	U	4.7	5.9		5.9
	BAV1 Vinyl Chloride Reductase (BVC)	ND	U	0.5	ND	U	0.5	0.6		0.6
	cer A Reductase	ND	U	4.9	ND	U	4.7	5.9		5.9
	Chloroform Reductase (CFR)	ND	U	4.9	ND	U	4.7	5.9		5.9
	Dehalobacter DCM (DCM)	299		4.9	ND	U	4.7	5.9		5.9
	Dehalobacter spp. (DHBt)	142000		4.9	426000		4.7	196000		5.9
	Dehalobium chloro-coercia (DECO)	1710		4.9	1880		4.7	541		5.9
	Dehalococcoides (DHC)	1.2		0.5	0.4	J	0.5	4.8		0.6
	Dehalogenimonas spp. (DHG)	212		4.9	ND	U	4.7	5.9		5.9
	Desulfotobacterium spp. (DSB)	103000		4.9	319000		4.7	140000		5.9
	Desulfuromonas spp. (DSM)	ND	U	4.9	ND	U	4.7	5.9		5.9
	Dichloromethane Dehalogenase (DCMA)	ND	U	4.9	ND	U	4.7	5.9		5.9
	Epoxyalkane Transferase (EtnE)	ND	U	4.9	ND	U	4.7	5.9		5.9
	Ethene Monooxygenase (EtnC)	ND	U	4.9	ND	U	4.7	5.9		5.9
	Methanogens (MGN)	31600		4.9	42400		4.7	44300		5.9
	PCE Reductase (PCE-1)	ND	U	4.9	ND	U	4.7	5.9		5.9
	Phenol Hydroxylase (PHE)	6630		4.9	4340		4.7	16600		5.9
	PMMO	NA	--	--	NA	--	--	NA	--	--
	Soluble Methane Monooxygenase (SMMO)	ND	U	4.9	ND	U	4.7	5.9		5.9
	Sulfate Reducing Bacteria (APS)	29500		4.9	17400		4.7	34500		5.9
	tceA Reductase (TCE)	ND	U	0.5	ND	U	0.5	0.6		0.6
	Toluene Dioxygenase (TOD)	ND	U	4.9	ND	U	4.7	5.9		5.9
	Toluene Monooxygenase (RMO)	5060		4.9	12400		4.7	18200		5.9
	Toluene Monooxygenase 2 (RDEG)	2970		4.9	5740		4.7	5920		5.9
Total Eubacteria (EBAC)	5450000		4.9	9050000		4.7	12700000		5.9	
trans-1,2-DCE Reductase (TDR)	ND	U	4.9	ND	U	4.7	5.9		5.9	
Trichlorobenzene Dioxygenase (TCBO)	ND	U	4.9	203		4.7	164		5.9	
Vinyl Chloride Reductase (VCR)	ND	U	0.5	ND	U	0.5	0.6		0.6	
EDB (µg/L) EPA Method 8011	1,2-DIBROMOETHANE	0.12		0.01	ND	U	0.011	ND	U	0.01
VFAs (mg/L) EPA Method 300m	ACETIC ACID	ND	U	10	0.6	J	10	1.7		10
	BUTYRIC ACID	ND	U	10	ND	U	10	ND	U	10
	FORMIC ACID	0.4	J	10	3.3	J	10	2.4	J	10
	LACTIC ACID	ND	U	10	1.1	J	10	0.7	J	10
	PROPIONIC ACID	ND	U	10	ND	U	10	ND	U	10
	PYRUVIC ACID	ND	U	10	ND	U	10	ND	U	10
VALERIC ACID	ND	U	10	ND	U	10	ND	U	10	
Fluorometric (µg/L) Spectrofluorophotometry	FLUORESC EIN	NS	--	--	NS	--	--	NS	--	--
Reduced Gases (µg/L) RSKSOP-175	ACETYLENE	ND	U	10	ND	U	10	ND	U	10
	ETHANE	2	J	4	2.9	J	4	0.8	J	4
	ETHYLENE	6.5		5	8		5	3.6	J	5
	METHANE	6636.4		2	8461.1		2	2141.2		2
	PROPANE	2.9	J	6	4.3	J	6	0.8	J	6
General Chemistry (mg/L) SM2320b, EPA Method 300, EPA Method 353.2, SM4500 Pe ^c	ALKALINITY	584		5	604		5	584		5
	BROMIDE	0.854		0.1	2.13		0.1	1.59		0.1
	CHLORIDE	48.8		0.5	52		0.5	48.2		0.5
	IODIDE	8.9		0.2	6.8		2	7.2		
	NITRATE	0.0727	J	0.1	0.0741	J	0.1	ND	U	0.1
	NITRITE	NA	--	--	NA	--	--	NA	--	--
	NITROGEN, NITRATE-NITRITE	ND	U	0.1	ND	U	0.1	ND	U	0.1
	O-PHOSPHATE (AS P)	NA	--	--	NA	--	--	NA	--	--
	ORTHOPHOSPHATE	NA	--	--	NA	--	--	NA	--	--
PHOSPHORUS	ND	U	0.025	ND	U	0.025	ND	U	0.025	
SULFATE	0.202	J	0.5	0.321	J	0.5	ND	U	0.5	

Table 9
Analytical Data Table for KAFB-106EX1

Phase Designation		Phase 4 Passive								
Sample ID		106EX1-LTM-052020			106EX1-LTM-080420			106EX1-LTM-101520		
Sample Date		5/20/2020			8/4/2020			10/15/2020		
Sample Purpose		REG			REG			REG		
Chemical Class and Analytical Method ^a	Parameter	Result	Val Qual	LOQ	Result	Val Qual	LOQ	Result	Val Qual	LOQ
Metals (mg/L) EPA Method 6010	LEAD	0.000687	J	0.001	0.00069	J	0.001	ND	U	0.001
Dissolved Metals (mg/L) EPA Method 6010	IRON	9.88		0.05	7.65		0.05	3.3		0.05
	MANGANESE	4.86		0.05	5.17		0.125	4.57		0.125
δ ² H (‰) Mass Spectrometry, USGS Reston, VA	DELTA2H	NS	--	--	NS	--	--	NS	--	--
CSIA EDB δ ¹³ C (‰) Kuder et al, 2012	EDB δ	NS	--	--	NS	--	--	NS	--	--
VOCs (µg/L) EPA Method 8260	1,1,2-TRICHLOROETHANE	ND	U	5	ND	U	10	ND	U	5
	1,2,4-TRICHLOROBENZENE	ND	U	5	ND	U	10	ND	U	5
	1,2,4-TRIMETHYLBENZENE	NA	--	--	NA	--	--	NA	--	--
	1,2-DIBROMOETHANE	ND	U	2.5	ND	U	5	ND	U	2.5
	1,2-DICHLOROETHANE	ND	U	2.5	ND	U	5	ND	U	2.5
	1,3,5-TRIMETHYLBENZENE	79		5	77		10	46		5
	2-BUTANONE	ND	U	5	ND	U	10	ND	U	5
	2-CHLOROTOLUENE	ND	U	5	ND	U	10	ND	U	2.5
	2-HEXANONE	ND	U	10	ND	U	20	ND	U	10
	4-METHYL-2-PENTANONE	ND	U	10	ND	U	10	ND	U	10
	ACETONE	14		5	58		10	ND	U	5
	BENZENE	2500		12	3400		50	2500		25
	CARBON DISULFIDE	ND	U	5	ND	U	10	ND	U	10
	CHLOROMETHANE	ND	U	2.5	ND	U	5	ND	U	2.5
	CIS-1,2-DICHLOROETHENE	ND	U	2.5	ND	U	5	ND	U	2.5
	DICHLORODIFLUOROMETHANE	ND	U	5	ND	U	10	ND	U	2.5
	ETHYLBENZENE	630		5	640		10	140		5
	ISOPROPYLBENZENE	100		5	100		10	23		2.5
	M,P-XYLENES	1300		5	1300		10	400		5
	METHYL TERT-BUTYL ETHER	ND	U	2.5	ND	U	5	ND	U	2.5
	METHYLENE CHLORIDE	9.8	J	5	ND	U	10	ND	U	5
	NAPHTHALENE	97		5	100		10	41		2.5
	N-BUTYLBENZENE	10		5	ND	U	10	ND	U	5
	N-PROPYLBENZENE	48		5	44		10	ND	U	5
	O-XYLENE	700		5	740		10	460		5
	P-ISOPROPYLTOLUENE	45		5	ND	U	10	ND	U	5
	SEC-BUTYLBENZENE	11		5	11		10	ND	U	2.5
	TERT-BUTYLBENZENE	ND	U	5	ND	U	10	ND	U	5
	TETRACHLOROETHENE	ND	U	5	ND	U	10	ND	U	2.5
	TOLUENE	160		2.5	53		5	13		2.5
	TRANS-1,2-DICHLOROETHENE	ND	U	2.5	ND	U	5	ND	U	2.5
	TRICHLOROETHENE	ND	U	2.5	ND	U	5	ND	U	2.5
	TRICHLOROFUOROMETHANE	ND	U	5	ND	U	10	ND	U	2.5
	VINYL CHLORIDE	ND	U	2.5	ND	U	5	ND	U	2.5
	XYLENES	2000		5	2000		10	870		2.5

Refer to notes at the end of the table.

Table 9
Analytical Data Table for KAFB-106EX1

Notes:

Sampling frequency for each analytical method is outlined in Table 4.

a. EPA analytical methods listed are for the most recent sampling event.

b. Samples were collected using Geotech Bladder Pumps.

c. Samples were recollected (except for QuantArray-Chlor analysis) using replacement QED Bladder Pumps.

-- = Not applicable.

δ2H - Delta Deuterium.

0/00 - Per mil.

cells/mL = Cells per milliliter.

EPA = Environmental Protection Agency.

FD = Field duplicate.

ID = Identification.

J = Estimated value, concentration is less than LOQ but greater than laboratory method detection limit (DL).

J+ = Estimated value, concentration is less than LOQ but greater than laboratory method detection limit (DL); biased high.

J- = Estimated value, concentration is less than LOQ but greater than laboratory method detection limit (DL); biased low.

KAFB = Kirtland Air Force Base.

LOQ = Limit of Quantitation

µg/L = Microgram per liter.

mg/L = Milligram per liter.

NA = Not analyzed.

ND = Not detected.

NS = Not sampled.

REG = Regular/parent sample.

U = Analyte was not detected. The reported numerical value is at or below the LOQ.

UJ = Analyte was not detected. The reported value is estimated.

VAL QUAL = Validation qualifier.

VFA - Volatile fatty acid.

VOC = Volatile organic compound.

Table 10
Analytical Data Table for KAFB-106EX2

Phase Designation		Original Baseline ^b			New Baseline - QED Pumps ^c			Phase 1 Recirculation					
Sample ID		106EX2-BL-062917			106EX2-BL-092617			106EX2-P1R-100417			106EX2-P1R-100617		
Sample Date		6/29/2017			9/26/2017			10/4/2017			10/6/2017		
Sample Purpose		REG			REG			REG			REG		
Chemical Class and Analytical Method ^a	Parameter	Result	Val Qual	LOQ	Result	Val Qual	LOQ	Result	Val Qual	LOQ	Result	Val Qual	LOQ
Microbial Community (cells/mL) QuantArray-Chlor	1,1 DCA Reductase (DCA)	ND	U	5.3	NS	--	--	NS	--	--	NS	--	--
	1,2 DCA Reductase (DCAR)	ND	U	5.3	NS	--	--	NS	--	--	NS	--	--
	BAV1 Vinyl Chloride Reductase (BVC)	ND	U	0.5	NS	--	--	NS	--	--	NS	--	--
	cer A Reductase	NA	--	--	NS	--	--	NS	--	--	NS	--	--
	Chloroform Reductase (CFR)	1600		5.3	NS	--	--	NS	--	--	NS	--	--
	Dehalobacter DCM (DCM)	ND	U	5.3	NS	--	--	NS	--	--	NS	--	--
	Dehalobacter spp. (DHBt)	117000		5.3	NS	--	--	NS	--	--	NS	--	--
	Dehalobium chloroercoercia (DECO)	29900		5.3	NS	--	--	NS	--	--	NS	--	--
	Dehalococcoides (DHC)	ND	U	0.5	NS	--	--	NS	--	--	NS	--	--
	Dehalogenimonas spp. (DHG)	ND	U	5.3	NS	--	--	NS	--	--	NS	--	--
	Desulfotobacterium spp. (DSB)	66900		5.3	NS	--	--	NS	--	--	NS	--	--
	Desulfuromonas spp. (DSM)	ND	U	5.3	NS	--	--	NS	--	--	NS	--	--
	Dichloromethane Dehalogenase (DCMA)	ND	U	5.3	NS	--	--	NS	--	--	NS	--	--
	Epoxyalkane Transferase (EtnE)	ND	U	5.3	NS	--	--	NS	--	--	NS	--	--
	Ethene Monooxygenase (EtnC)	ND	U	5.3	NS	--	--	NS	--	--	NS	--	--
	Methanogens (MGN)	29.7		5.3	NS	--	--	NS	--	--	NS	--	--
	PCE Reductase (PCE-1)	NA	--	--	NS	--	--	NS	--	--	NS	--	--
	Phenol Hydroxylase (PHE)	38900		5.3	NS	--	--	NS	--	--	NS	--	--
	PMMO	108		5.3	NS	--	--	NS	--	--	NS	--	--
	Soluble Methane Monooxygenase (SMMO)	229		5.3	NS	--	--	NS	--	--	NS	--	--
	Sulfate Reducing Bacteria (APS)	124000		5.3	NS	--	--	NS	--	--	NS	--	--
	tceA Reductase (TCE)	ND	U	0.5	NS	--	--	NS	--	--	NS	--	--
	Toluene Dioxygenase (TOD)	36.8		5.3	NS	--	--	NS	--	--	NS	--	--
	Toluene Monooxygenase (RMO)	45100		5.3	NS	--	--	NS	--	--	NS	--	--
Toluene Monooxygenase 2 (RDEG)	14500		5.3	NS	--	--	NS	--	--	NS	--	--	
Total Eubacteria (EBAC)	818000		5.3	NS	--	--	NS	--	--	NS	--	--	
trans-1,2-DCE Reductase (TDR)	NA	--	--	NS	--	--	NS	--	--	NS	--	--	
Trichlorobenzene Dioxygenase (TCBO)	190		5.3	NS	--	--	NS	--	--	NS	--	--	
Vinyl Chloride Reductase (VCR)	ND	U	0.5	NS	--	--	NS	--	--	NS	--	--	
EDB (µg/L) EPA Method 8011	1,2-DIBROMOETHANE	143		9.53	143	J+	7.59	NS	--	--	NS	--	--
VFAs (mg/L) EPA Method 300m	ACETIC ACID	ND	U	1	ND	U	1	NS	--	--	NS	--	--
	BUTYRIC ACID	ND	U	1	ND	U	1	NS	--	--	NS	--	--
	FORMIC ACID	ND	U	1	ND	U	1	NS	--	--	NS	--	--
	LACTIC ACID	ND	U	1	ND	U	1	NS	--	--	NS	--	--
	PROPIONIC ACID	ND	U	1	ND	U	1	NS	--	--	NS	--	--
	PYRUVIC ACID	ND	U	1	ND	U	1	NS	--	--	NS	--	--
	VALERIC ACID	ND	U	1	ND	U	1	NS	--	--	NS	--	--
Fluorometric (µg/L) Spectrofluorophotometry	FLUORESCEIN	ND	U	0.01	ND	U	0.01	ND	U	0.01	ND	U	0.01
Reduced Gases (µg/L) RSKSOP-175	ACETYLENE	ND	U	10	ND	U	10	NS	--	--	NS	--	--
	ETHANE	1.34	J	4	2.63	J	4	NS	--	--	NS	--	--
	ETHYLENE	0.98	J	5	2.54	J	5	NS	--	--	NS	--	--
	METHANE	1.48	J	2	4.08		2	NS	--	--	NS	--	--
	PROPANE	1.82	J	6	ND	U	6	NS	--	--	NS	--	--
General Chemistry (mg/L) SM2320b, EPA Method 300, EPA Method 353.2, SM4500 Pe ^c	ALKALINITY	279		1	309		1	NS	--	--	NS	--	--
	BROMIDE	0.998	J-	0.125	0.803		0.25	NS	--	--	NS	--	--
	CHLORIDE	91.3		0.66	91.5		0.66	NS	--	--	NS	--	--
	IODIDE	ND	U	0.2	ND	U	0.75	NS	--	--	NS	--	--
	NITRATE	NS	--	--	NS	--	--	NS	--	--	NS	--	--
	NITRITE	NS	--	--	NS	--	--	NS	--	--	NS	--	--
	NITROGEN, NITRATE-NITRITE	0.621		0.375	ND	U	0.375	NS	--	--	NS	--	--
	O-PHOSPHATE (AS P)	0.0275		0.02	0.196	J+	0.02	NS	--	--	NS	--	--
	ORTHOPHOSPHATE	NS	--	--	NS	--	--	NS	--	--	NS	--	--
	PHOSPHORUS	NS	--	--	NS	--	--	NS	--	--	NS	--	--
	SULFATE	26.8		2	25		2	NS	--	--	NS	--	--
Metals (mg/L) EPA Method 6010	LEAD	NS	--	--	NS	--	--	NS	--	--	NS	--	--

Table 10
Analytical Data Table for KAFB-106EX2

Phase Designation		Original Baseline ^b			New Baseline - QED Pumps ^c			Phase 1 Recirculation					
Sample ID		106EX2-BL-062917			106EX2-BL-092617			106EX2-P1R-100417			106EX2-P1R-100617		
Sample Date		6/29/2017			9/26/2017			10/4/2017			10/6/2017		
Sample Purpose		REG			REG			REG			REG		
Chemical Class and Analytical Method ^a	Parameter	Result	Val Qual	LOQ	Result	Val Qual	LOQ	Result	Val Qual	LOQ	Result	Val Qual	LOQ
Dissolved Metals (mg/L) EPA Method 6010	IRON	0.99		0.06	2.33		0.06	NS	--	--	NS	--	--
	MANGANESE	2.63		0.006	3.1		0.006	NS	--	--	NS	--	--
δ2H (‰) Mass Spectrometry, USGS Reston, VA	DELTA2H	-93.16		-99	-91.73		-99	-92.4		-99	-93.58		-99
CSIA EDB δ13C (‰) Kuder et al, 2012	EDB δ	-19.5 ±2‰	--	--	-18.1 ±2‰	--	--	NS	--	--	NS	--	--
VOCs (µg/L) EPA Method 8260	1,1,2-TRICHLOROETHANE	ND	U	50	ND	U	50	NS	--	--	NS	--	--
	1,2,4-TRICHLOROBENZENE	NA	--	--	NA	--	--	NS	--	--	NS	--	--
	1,2,4-TRIMETHYLBENZENE	190		50	178		50	NS	--	--	NS	--	--
	1,2-DIBROMOETHANE	154		50	146		50	NS	--	--	NS	--	--
	1,2-DICHLOROETHANE	ND	U	50	ND	U	50	NS	--	--	NS	--	--
	1,3,5-TRIMETHYLBENZENE	65	J	50	69.8	J	50	NS	--	--	NS	--	--
	2-BUTANONE	ND	U	500	ND	U	500	NS	--	--	NS	--	--
	2-CHLOROTOLUENE	ND	U	50	ND	U	50	NS	--	--	NS	--	--
	2-HEXANONE	277	J	250	281	J	250	NS	--	--	NS	--	--
	4-METHYL-2-PENTANONE	ND	U	250	ND	U	250	NS	--	--	NS	--	--
	ACETONE	1340		500	1040		500	NS	--	--	NS	--	--
	BENZENE	3700		50	3270		50	NS	--	--	NS	--	--
	CARBON DISULFIDE	ND	U	50	27.6	J	50	NS	--	--	NS	--	--
	CHLOROMETHANE	ND	U	50	ND	U	50	NS	--	--	NS	--	--
	CIS-1,2-DICHLOROETHENE	NA	--	--	NA	--	--	NS	--	--	NS	--	--
	DICHLORODIFLUOROMETHANE	ND	U	100	ND	U	100	NS	--	--	NS	--	--
	ETHYLBENZENE	697		50	692		50	NS	--	--	NS	--	--
	ISOPROPYLBENZENE	45.8	J+	50	52.5	J	50	NS	--	--	NS	--	--
	M,P-XYLENES	NA	--	--	NA	--	--	NS	--	--	NS	--	--
	METHYL TERT-BUTYL ETHER	ND	U	50	ND	U	50	NS	--	--	NS	--	--
	METHYLENE CHLORIDE	ND	U	100	ND	U	100	NS	--	--	NS	--	--
	NAPHTHALENE	73.4	J+	50	66.4	J	50	NS	--	--	NS	--	--
	N-BUTYLBENZENE	ND	U	50	ND	U	50	NS	--	--	NS	--	--
	N-PROPYLBENZENE	59.4	J	50	57.7	J	50	NS	--	--	NS	--	--
	O-XYLENE	NA	--	--	NA	--	--	NS	--	--	NS	--	--
	P-ISOPROPYLTOLUENE	ND	U	50	ND	U	50	NS	--	--	NS	--	--
	SEC-BUTYLBENZENE	ND	U	50	ND	U	50	NS	--	--	NS	--	--
	TERT-BUTYLBENZENE	ND	U	50	ND	U	50	NS	--	--	NS	--	--
TETRACHLOROETHENE	NA	--	--	NA	--	--	NS	--	--	NS	--	--	
TOLUENE	8290		50	6600		50	NS	--	--	NS	--	--	
TRANS-1,2-DICHLOROETHENE	NA	--	--	NA	--	--	NS	--	--	NS	--	--	
TRICHLOROETHENE	ND	U	50	ND	U	50	NS	--	--	NS	--	--	
TRICHLOROFLUOROMETHANE	ND	U	100	ND	U	100	NS	--	--	NS	--	--	
VINYL CHLORIDE	NA	--	--	NA	--	--	NS	--	--	NS	--	--	
XYLENES	2620		150	2350		150	NS	--	--	NS	--	--	

Refer to notes at the end of the table.

Table 10
Analytical Data Table for KAFB-106EX2

Phase Designation		Phase 1 Recirculation											
Sample ID		106EX2-P1R-100917			106EX2-P1R-101217			106EX2-P1R-101617			106EX2-P1R-102017		
Sample Date		10/9/2017			10/12/2017			10/16/2017			10/20/2017		
Sample Purpose		REG			REG			REG			REG		
Chemical Class and Analytical Method ^a	Parameter	Result	Val Qual	LOQ	Result	Val Qual	LOQ	Result	Val Qual	LOQ	Result	Val Qual	LOQ
Microbial Community (cells/mL) QuantArray-Chlor	1,1 DCA Reductase (DCA)	NS	--	--	NS	--	--	NS	--	--	NS	--	--
	1,2 DCA Reductase (DCAR)	NS	--	--	NS	--	--	NS	--	--	NS	--	--
	BAV1 Vinyl Chloride Reductase (BVC)	NS	--	--	NS	--	--	NS	--	--	NS	--	--
	cer A Reductase	NS	--	--	NS	--	--	NS	--	--	NS	--	--
	Chloroform Reductase (CFR)	NS	--	--	NS	--	--	NS	--	--	NS	--	--
	Dehalobacter DCM (DCM)	NS	--	--	NS	--	--	NS	--	--	NS	--	--
	Dehalobacter spp. (DHBt)	NS	--	--	NS	--	--	NS	--	--	NS	--	--
	Dehalobium chloroercoercia (DECO)	NS	--	--	NS	--	--	NS	--	--	NS	--	--
	Dehalococcoides (DHC)	NS	--	--	NS	--	--	NS	--	--	NS	--	--
	Dehalogenimonas spp. (DHG)	NS	--	--	NS	--	--	NS	--	--	NS	--	--
	Desulfotobacterium spp. (DSB)	NS	--	--	NS	--	--	NS	--	--	NS	--	--
	Desulfuromonas spp. (DSM)	NS	--	--	NS	--	--	NS	--	--	NS	--	--
	Dichloromethane Dehalogenase (DCMA)	NS	--	--	NS	--	--	NS	--	--	NS	--	--
	Epoxyalkane Transferase (EtnE)	NS	--	--	NS	--	--	NS	--	--	NS	--	--
	Ethene Monooxygenase (EtnC)	NS	--	--	NS	--	--	NS	--	--	NS	--	--
	Methanogens (MGN)	NS	--	--	NS	--	--	NS	--	--	NS	--	--
	PCE Reductase (PCE-1)	NS	--	--	NS	--	--	NS	--	--	NS	--	--
	Phenol Hydroxylase (PHE)	NS	--	--	NS	--	--	NS	--	--	NS	--	--
	PMMO	NS	--	--	NS	--	--	NS	--	--	NS	--	--
	Soluble Methane Monooxygenase (SMMO)	NS	--	--	NS	--	--	NS	--	--	NS	--	--
	Sulfate Reducing Bacteria (APS)	NS	--	--	NS	--	--	NS	--	--	NS	--	--
	tceA Reductase (TCE)	NS	--	--	NS	--	--	NS	--	--	NS	--	--
	Toluene Dioxygenase (TOD)	NS	--	--	NS	--	--	NS	--	--	NS	--	--
Toluene Monooxygenase (RMO)	NS	--	--	NS	--	--	NS	--	--	NS	--	--	
Toluene Monooxygenase 2 (RDEG)	NS	--	--	NS	--	--	NS	--	--	NS	--	--	
Total Eubacteria (EBAC)	NS	--	--	NS	--	--	NS	--	--	NS	--	--	
trans-1,2-DCE Reductase (TDR)	NS	--	--	NS	--	--	NS	--	--	NS	--	--	
Trichlorobenzene Dioxygenase (TCBO)	NS	--	--	NS	--	--	NS	--	--	NS	--	--	
Vinyl Chloride Reductase (VCR)	NS	--	--	NS	--	--	NS	--	--	NS	--	--	
EDB (µg/L) EPA Method 8011	1,2-DIBROMOETHANE	NS	--	--	NS	--	--	NS	--	--	NS	--	--
VFAs (mg/L) EPA Method 300m	ACETIC ACID	NS	--	--	NS	--	--	NS	--	--	NS	--	--
	BUTYRIC ACID	NS	--	--	NS	--	--	NS	--	--	NS	--	--
	FORMIC ACID	NS	--	--	NS	--	--	NS	--	--	NS	--	--
	LACTIC ACID	NS	--	--	NS	--	--	NS	--	--	NS	--	--
	PROPIONIC ACID	NS	--	--	NS	--	--	NS	--	--	NS	--	--
	PYRUVIC ACID	NS	--	--	NS	--	--	NS	--	--	NS	--	--
	VALERIC ACID	NS	--	--	NS	--	--	NS	--	--	NS	--	--
Fluorometric (µg/L) Spectrofluorophotometry	FLUORESCIEIN	0.275		0.01	3.242		0.01	5.394		0.01	6.778		0.01
Reduced Gases (µg/L) RSKSOP-175	ACETYLENE	NS	--	--	NS	--	--	NS	--	--	NS	--	--
	ETHANE	NS	--	--	NS	--	--	NS	--	--	NS	--	--
	ETHYLENE	NS	--	--	NS	--	--	NS	--	--	NS	--	--
	METHANE	NS	--	--	NS	--	--	NS	--	--	NS	--	--
	PROPANE	NS	--	--	NS	--	--	NS	--	--	NS	--	--
General Chemistry (mg/L) SM2320b, EPA Method 300, EPA Method 353.2, SM4500 Pe ^c	ALKALINITY	NS	--	--	NS	--	--	NS	--	--	NS	--	--
	BROMIDE	NS	--	--	NS	--	--	NS	--	--	NS	--	--
	CHLORIDE	NS	--	--	NS	--	--	NS	--	--	NS	--	--
	IODIDE	NS	--	--	NS	--	--	NS	--	--	NS	--	--
	NITRATE	NS	--	--	NS	--	--	NS	--	--	NS	--	--
	NITRITE	NS	--	--	NS	--	--	NS	--	--	NS	--	--
	NITROGEN, NITRATE-NITRITE	NS	--	--	NS	--	--	NS	--	--	NS	--	--
	O-PHOSPHATE (AS P)	NS	--	--	NS	--	--	NS	--	--	NS	--	--
	ORTHOPHOSPHATE	NS	--	--	NS	--	--	NS	--	--	NS	--	--
	PHOSPHORUS	NS	--	--	NS	--	--	NS	--	--	NS	--	--
	SULFATE	NS	--	--	NS	--	--	NS	--	--	NS	--	--
Metals (mg/L) EPA Method 6010	LEAD	NS	--	--	NS	--	--	NS	--	--	NS	--	--

Table 10
Analytical Data Table for KAFB-106EX2

Phase Designation		Phase 1 Recirculation											
Sample ID		106EX2-P1R-100917			106EX2-P1R-101217			106EX2-P1R-101617			106EX2-P1R-102017		
Sample Date		10/9/2017			10/12/2017			10/16/2017			10/20/2017		
Sample Purpose		REG			REG			REG			REG		
Chemical Class and Analytical Method ^a	Parameter	Result	Val Qual	LOQ	Result	Val Qual	LOQ	Result	Val Qual	LOQ	Result	Val Qual	LOQ
Dissolved Metals (mg/L) EPA Method 6010	IRON	NS	--	--	NS	--	--	NS	--	--	NS	--	--
	MANGANESE	NS	--	--	NS	--	--	NS	--	--	NS	--	--
δ2H (‰) Mass Spectrometry, USGS Reston, VA	DELTA2H	-92.76		-99	-91.11		-99	-87.24		-99	-85.66		-99
CSIA EDB δ13C (‰) Kuder et al, 2012	EDB δ	NS	--	--	NS	--	--	NS	--	--	NS	--	--
VOCs (µg/L) EPA Method 8260	1,1,2-TRICHLOROETHANE	NS	--	--	NS	--	--	NS	--	--	NS	--	--
	1,2,4-TRICHLOROBENZENE	NS	--	--	NS	--	--	NS	--	--	NS	--	--
	1,2,4-TRIMETHYLBENZENE	NS	--	--	NS	--	--	NS	--	--	NS	--	--
	1,2-DIBROMOETHANE	NS	--	--	NS	--	--	NS	--	--	NS	--	--
	1,2-DICHLOROETHANE	NS	--	--	NS	--	--	NS	--	--	NS	--	--
	1,3,5-TRIMETHYLBENZENE	NS	--	--	NS	--	--	NS	--	--	NS	--	--
	2-BUTANONE	NS	--	--	NS	--	--	NS	--	--	NS	--	--
	2-CHLOROTOLUENE	NS	--	--	NS	--	--	NS	--	--	NS	--	--
	2-HEXANONE	NS	--	--	NS	--	--	NS	--	--	NS	--	--
	4-METHYL-2-PENTANONE	NS	--	--	NS	--	--	NS	--	--	NS	--	--
	ACETONE	NS	--	--	NS	--	--	NS	--	--	NS	--	--
	BENZENE	NS	--	--	NS	--	--	NS	--	--	NS	--	--
	CARBON DISULFIDE	NS	--	--	NS	--	--	NS	--	--	NS	--	--
	CHLOROMETHANE	NS	--	--	NS	--	--	NS	--	--	NS	--	--
	CIS-1,2-DICHLOROETHENE	NS	--	--	NS	--	--	NS	--	--	NS	--	--
	DICHLORODIFLUOROMETHANE	NS	--	--	NS	--	--	NS	--	--	NS	--	--
	ETHYLBENZENE	NS	--	--	NS	--	--	NS	--	--	NS	--	--
	ISOPROPYLBENZENE	NS	--	--	NS	--	--	NS	--	--	NS	--	--
	M,P-XYLENES	NS	--	--	NS	--	--	NS	--	--	NS	--	--
	METHYL TERT-BUTYL ETHER	NS	--	--	NS	--	--	NS	--	--	NS	--	--
	METHYLENE CHLORIDE	NS	--	--	NS	--	--	NS	--	--	NS	--	--
	NAPHTHALENE	NS	--	--	NS	--	--	NS	--	--	NS	--	--
	N-BUTYLBENZENE	NS	--	--	NS	--	--	NS	--	--	NS	--	--
	N-PROPYLBENZENE	NS	--	--	NS	--	--	NS	--	--	NS	--	--
	O-XYLENE	NS	--	--	NS	--	--	NS	--	--	NS	--	--
	P-ISOPROPYLTOLUENE	NS	--	--	NS	--	--	NS	--	--	NS	--	--
	SEC-BUTYLBENZENE	NS	--	--	NS	--	--	NS	--	--	NS	--	--
	TERT-BUTYLBENZENE	NS	--	--	NS	--	--	NS	--	--	NS	--	--
	TETRACHLOROETHENE	NS	--	--	NS	--	--	NS	--	--	NS	--	--
	TOLUENE	NS	--	--	NS	--	--	NS	--	--	NS	--	--
TRANS-1,2-DICHLOROETHENE	NS	--	--	NS	--	--	NS	--	--	NS	--	--	
TRICHLOROETHENE	NS	--	--	NS	--	--	NS	--	--	NS	--	--	
TRICHLOROFLUOROMETHANE	NS	--	--	NS	--	--	NS	--	--	NS	--	--	
VINYL CHLORIDE	NS	--	--	NS	--	--	NS	--	--	NS	--	--	
XYLENES	NS	--	--	NS	--	--	NS	--	--	NS	--	--	

Refer to notes at the end of the table.

Table 10
Analytical Data Table for KAFB-106EX2

Phase Designation		Phase 1 Recirculation									Phase 1 Passive		
Sample ID		106EX2-P1R-102517			106EX2-P1R-110117			106EX2-P1R-110117-FD			106EX2-P1P-111617		
Sample Date		10/25/2017			11/1/2017			11/1/2017			11/16/2017		
Sample Purpose		REG			REG			FD			REG		
Chemical Class and Analytical Method ^a	Parameter	Result	Val Qual	LOQ	Result	Val Qual	LOQ	Result	Val Qual	LOQ	Result	Val Qual	LOQ
Microbial Community (cells/mL) QuantArray-Chlor	1,1 DCA Reductase (DCA)	NS	--	--	NS	--	--	NS	--	--	NS	--	--
	1,2 DCA Reductase (DCAR)	NS	--	--	NS	--	--	NS	--	--	NS	--	--
	BAV1 Vinyl Chloride Reductase (BVC)	NS	--	--	NS	--	--	NS	--	--	NS	--	--
	cer A Reductase	NS	--	--	NS	--	--	NS	--	--	NS	--	--
	Chloroform Reductase (CFR)	NS	--	--	NS	--	--	NS	--	--	NS	--	--
	Dehalobacter DCM (DCM)	NS	--	--	NS	--	--	NS	--	--	NS	--	--
	Dehalobacter spp. (DHBt)	NS	--	--	NS	--	--	NS	--	--	NS	--	--
	Dehalobium chloroercoercia (DECO)	NS	--	--	NS	--	--	NS	--	--	NS	--	--
	Dehalococcoides (DHC)	NS	--	--	NS	--	--	NS	--	--	NS	--	--
	Dehalogenimonas spp. (DHG)	NS	--	--	NS	--	--	NS	--	--	NS	--	--
	Desulfotobacterium spp. (DSB)	NS	--	--	NS	--	--	NS	--	--	NS	--	--
	Desulfuromonas spp. (DSM)	NS	--	--	NS	--	--	NS	--	--	NS	--	--
	Dichloromethane Dehalogenase (DCMA)	NS	--	--	NS	--	--	NS	--	--	NS	--	--
	Epoxyalkane Transferase (EtnE)	NS	--	--	NS	--	--	NS	--	--	NS	--	--
	Ethene Monooxygenase (EtnC)	NS	--	--	NS	--	--	NS	--	--	NS	--	--
	Methanogens (MGN)	NS	--	--	NS	--	--	NS	--	--	NS	--	--
	PCE Reductase (PCE-1)	NS	--	--	NS	--	--	NS	--	--	NS	--	--
	Phenol Hydroxylase (PHE)	NS	--	--	NS	--	--	NS	--	--	NS	--	--
	PMMO	NS	--	--	NS	--	--	NS	--	--	NS	--	--
	Soluble Methane Monooxygenase (SMMO)	NS	--	--	NS	--	--	NS	--	--	NS	--	--
	Sulfate Reducing Bacteria (APS)	NS	--	--	NS	--	--	NS	--	--	NS	--	--
	tceA Reductase (TCE)	NS	--	--	NS	--	--	NS	--	--	NS	--	--
	Toluene Dioxygenase (TOD)	NS	--	--	NS	--	--	NS	--	--	NS	--	--
Toluene Monooxygenase (RMO)	NS	--	--	NS	--	--	NS	--	--	NS	--	--	
Toluene Monooxygenase 2 (RDEG)	NS	--	--	NS	--	--	NS	--	--	NS	--	--	
Total Eubacteria (EBAC)	NS	--	--	NS	--	--	NS	--	--	NS	--	--	
trans-1,2-DCE Reductase (TDR)	NS	--	--	NS	--	--	NS	--	--	NS	--	--	
Trichlorobenzene Dioxygenase (TCBO)	NS	--	--	NS	--	--	NS	--	--	NS	--	--	
Vinyl Chloride Reductase (VCR)	NS	--	--	NS	--	--	NS	--	--	NS	--	--	
EDB (µg/L) EPA Method 8011	1,2-DIBROMOETHANE	137		9.48	NS	--	--	NS	--	--	147		3.8
VFAs (mg/L) EPA Method 300m	ACETIC ACID	0.98	J	1	NS	--	--	NS	--	--	1.18		1
	BUTYRIC ACID	ND	U	1	NS	--	--	NS	--	--	ND	U	1
	FORMIC ACID	ND	U	1	NS	--	--	NS	--	--	ND	U	1
	LACTIC ACID	ND	U	1	NS	--	--	NS	--	--	ND	U	1
	PROPIONIC ACID	ND	U	1	NS	--	--	NS	--	--	ND	U	1
	PYRUVIC ACID	ND	U	1	NS	--	--	NS	--	--	ND	U	1
	VALERIC ACID	ND	U	1	NS	--	--	NS	--	--	ND	U	1
Fluorometric (µg/L) Spectrofluorophotometry	FLUORESCCEIN	10.117		0.01	8.221		0.01	8.337		0.01	6.291		0.01
Reduced Gases (µg/L) RSKSOP-175	ACETYLENE	ND	U	10	NS	--	--	NS	--	--	ND	U	10
	ETHANE	ND	U	4	NS	--	--	NS	--	--	ND	U	4
	ETHYLENE	ND	U	5	NS	--	--	NS	--	--	ND	U	5
	METHANE	ND	U	2	NS	--	--	NS	--	--	ND	U	2
	PROPANE	ND	U	6	NS	--	--	NS	--	--	ND	U	6
General Chemistry (mg/L) SM2320b, EPA Method 300, EPA Method 353.2, SM4500 Pe ^c	ALKALINITY	280		1	NS	--	--	NS	--	--	346		1
	BROMIDE	0.823		0.25	NS	--	--	NS	--	--	0.932		0.25
	CHLORIDE	83.1		0.66	NS	--	--	NS	--	--	90.8		0.66
	IODIDE	ND	U	0.75	NS	--	--	NS	--	--	ND	U	0.75
	NITRATE	NS	--	--	NS	--	--	NS	--	--	NS	--	--
	NITRITE	NS	--	--	NS	--	--	NS	--	--	NS	--	--
	NITROGEN, NITRATE-NITRITE	ND	U	0.375	NS	--	--	NS	--	--	ND	U	0.375
	O-PHOSPHATE (AS P)	0.116		0.02	NS	--	--	NS	--	--	0.0116	J	0.02
	ORTHOPHOSPHATE	NS	--	--	NS	--	--	NS	--	--	NS	--	--
	PHOSPHORUS	NS	--	--	NS	--	--	NS	--	--	NS	--	--
	SULFATE	28.5		2	NS	--	--	NS	--	--	28.6		2
Metals (mg/L) EPA Method 6010	LEAD	NS	--	--	NS	--	--	NS	--	--	NS	--	--

Table 10
Analytical Data Table for KAFB-106EX2

Phase Designation		Phase 1 Recirculation									Phase 1 Passive		
Sample ID		106EX2-P1R-102517			106EX2-P1R-110117			106EX2-P1R-110117-FD			106EX2-P1P-111617		
Sample Date		10/25/2017			11/1/2017			11/1/2017			11/16/2017		
Sample Purpose		REG			REG			FD			REG		
Chemical Class and Analytical Method ^a	Parameter	Result	Val Qual	LOQ	Result	Val Qual	LOQ	Result	Val Qual	LOQ	Result	Val Qual	LOQ
Dissolved Metals (mg/L) EPA Method 6010	IRON	0.19		0.06	NS	--	--	NS	--	--	0.701		0.06
	MANGANESE	2.05		0.006	NS	--	--	NS	--	--	2.5		0.006
δ2H (‰) Mass Spectrometry, USGS Reston, VA	DELTA2H	-85.6		-99	-84		-99	-83		-99	-86.66		-99
CSIA EDB δ13C (‰) Kuder et al, 2012	EDB δ	NS	--	--	NS	--	--	NS	--	--	NS	--	--
VOCs (µg/L) EPA Method 8260	1,1,2-TRICHLOROETHANE	ND	U	50	NS	--	--	NS	--	--	ND	U	50
	1,2,4-TRICHLOROBENZENE	NS	--	--	NS	--	--	NS	--	--	NS	--	--
	1,2,4-TRIMETHYLBENZENE	214		50	NS	--	--	NS	--	--	186		50
	1,2-DIBROMOETHANE	139		50	NS	--	--	NS	--	--	134		50
	1,2-DICHLOROETHANE	ND	U	50	NS	--	--	NS	--	--	ND	U	50
	1,3,5-TRIMETHYLBENZENE	79.3	J	50	NS	--	--	NS	--	--	64.8	J	50
	2-BUTANONE	ND	U	500	NS	--	--	NS	--	--	ND	U	500
	2-CHLOROTOLUENE	ND	U	50	NS	--	--	NS	--	--	ND	U	50
	2-HEXANONE	254	J	250	NS	--	--	NS	--	--	243	J	250
	4-METHYL-2-PENTANONE	158	J	250	NS	--	--	NS	--	--	157	J	250
	ACETONE	996	J	500	NS	--	--	NS	--	--	1020	J-	500
	BENZENE	3370		50	NS	--	--	NS	--	--	3250		50
	CARBON DISULFIDE	ND	U	50	NS	--	--	NS	--	--	ND	U	50
	CHLOROMETHANE	ND	U	50	NS	--	--	NS	--	--	ND	U	50
	CIS-1,2-DICHLOROETHENE	NA	--	--	NS	--	--	NS	--	--	NA	--	--
	DICHLORODIFLUOROMETHANE	ND	U	100	NS	--	--	NS	--	--	ND	U	100
	ETHYLBENZENE	597		50	NS	--	--	NS	--	--	594		50
	ISOPROPYLBENZENE	51.4	J	50	NS	--	--	NS	--	--	47.3	J	50
	M,P-XYLENES	NA	--	--	NS	--	--	NS	--	--	NA	--	--
	METHYL TERT-BUTYL ETHER	ND	U	50	NS	--	--	NS	--	--	ND	U	50
	METHYLENE CHLORIDE	ND	U	100	NS	--	--	NS	--	--	ND	U	100
	NAPHTHALENE	98.2	J	50	NS	--	--	NS	--	--	94.1	J	50
	N-BUTYLBENZENE	ND	U	50	NS	--	--	NS	--	--	ND	U	50
	N-PROPYLBENZENE	56.5	J	50	NS	--	--	NS	--	--	50.2	J	50
	O-XYLENE	NA	--	--	NS	--	--	NS	--	--	NA	--	--
	P-ISOPROPYLTOLUENE	ND	U	50	NS	--	--	NS	--	--	ND	U	50
	SEC-BUTYLBENZENE	ND	U	50	NS	--	--	NS	--	--	ND	U	50
	TERT-BUTYLBENZENE	ND	U	50	NS	--	--	NS	--	--	ND	U	50
TETRACHLOROETHENE	NA	--	--	NS	--	--	NS	--	--	NA	--	--	
TOLUENE	6890		50	NS	--	--	NS	--	--	6480		50	
TRANS-1,2-DICHLOROETHENE	NA	--	--	NS	--	--	NS	--	--	NA	--	--	
TRICHLOROETHENE	ND	U	50	NS	--	--	NS	--	--	ND	U	50	
TRICHLOROFLUOROMETHANE	ND	U	100	NS	--	--	NS	--	--	ND	U	100	
VINYL CHLORIDE	NA	--	--	NS	--	--	NS	--	--	NA	--	--	
XYLENES	2310		150	NS	--	--	NS	--	--	2120		150	

Refer to notes at the end of the table.

Table 10
Analytical Data Table for KAFB-106EX2

Phase Designation		Phase 1 Passive			Phase 2 Recirculation								
Sample ID		106EX2-P1P-112917			106EX2-P2R-011018			106EX2-P2R-011018-FD			106EX2-P2R-011618		
Sample Date		11/29/2017			1/10/2018			1/10/2018			1/16/2018		
Sample Purpose		REG			REG			FD			REG		
Chemical Class and Analytical Method ^a	Parameter	Result	Val Qual	LOQ	Result	Val Qual	LOQ	Result	Val Qual	LOQ	Result	Val Qual	LOQ
Microbial Community (cells/mL) QuantArray-Chlor	1,1 DCA Reductase (DCA)	ND	U	5	NS	--	--	NS	--	--	NS	--	--
	1,2 DCA Reductase (DCAR)	ND	U	5	NS	--	--	NS	--	--	NS	--	--
	BAV1 Vinyl Chloride Reductase (BVC)	0.7		0.5	NS	--	--	NS	--	--	NS	--	--
	cer A Reductase	NS	--	--	NS	--	--	NS	--	--	NS	--	--
	Chloroform Reductase (CFR)	ND	U	5	NS	--	--	NS	--	--	NS	--	--
	Dehalobacter DCM (DCM)	ND	U	5	NS	--	--	NS	--	--	NS	--	--
	Dehalobacter spp. (DHBt)	61500		5	NS	--	--	NS	--	--	NS	--	--
	Dehalobium chloroercoercia (DECO)	7710		5	NS	--	--	NS	--	--	NS	--	--
	Dehalococcoides (DHC)	4.4		0.5	NS	--	--	NS	--	--	NS	--	--
	Dehalogenimonas spp. (DHG)	ND	U	5	NS	--	--	NS	--	--	NS	--	--
	Desulfotobacterium spp. (DSB)	75900		5	NS	--	--	NS	--	--	NS	--	--
	Desulfuromonas spp. (DSM)	5.1		5	NS	--	--	NS	--	--	NS	--	--
	Dichloromethane Dehalogenase (DCMA)	ND	U	5	NS	--	--	NS	--	--	NS	--	--
	Epoxyalkane Transferase (EtnE)	ND	U	5	NS	--	--	NS	--	--	NS	--	--
	Ethene Monooxygenase (EtnC)	ND	U	5	NS	--	--	NS	--	--	NS	--	--
	Methanogens (MGN)	ND	U	5	NS	--	--	NS	--	--	NS	--	--
	PCE Reductase (PCE-1)	NA	--	--	NS	--	--	NS	--	--	NS	--	--
	Phenol Hydroxylase (PHE)	19200		5	NS	--	--	NS	--	--	NS	--	--
	PMMO	24.1		5	NS	--	--	NS	--	--	NS	--	--
	Soluble Methane Monooxygenase (SMMO)	ND	U	5	NS	--	--	NS	--	--	NS	--	--
	Sulfate Reducing Bacteria (APS)	79600		5	NS	--	--	NS	--	--	NS	--	--
	tceA Reductase (TCE)	5		0.5	NS	--	--	NS	--	--	NS	--	--
	Toluene Dioxygenase (TOD)	ND	U	5	NS	--	--	NS	--	--	NS	--	--
Toluene Monooxygenase (RMO)	94800		5	NS	--	--	NS	--	--	NS	--	--	
Toluene Monooxygenase 2 (RDEG)	50500		5	NS	--	--	NS	--	--	NS	--	--	
Total Eubacteria (EBAC)	6810000		5	NS	--	--	NS	--	--	NS	--	--	
trans-1,2-DCE Reductase (TDR)	NA	--	--	NS	--	--	NS	--	--	NS	--	--	
Trichlorobenzene Dioxygenase (TCBO)	93.3		5	NS	--	--	NS	--	--	NS	--	--	
Vinyl Chloride Reductase (VCR)	7.1		0.5	NS	--	--	NS	--	--	NS	--	--	
EDB (µg/L) EPA Method 8011	1,2-DIBROMOETHANE	118		4.8	61.4		9.59	70.2		9.49	90.1		3.78
VFAs (mg/L) EPA Method 300m	ACETIC ACID	1.5		1	3.74		1	7.32		1	13.8		1
	BUTYRIC ACID	ND	U	1	ND	U	1	ND	U	1	ND	U	1
	FORMIC ACID	ND	U	1	ND	U	1	ND	U	1	ND	U	1
	LACTIC ACID	ND	U	1	0.79	J	1	1.63		1	1.35		1
	PROPIONIC ACID	ND	U	1	1.52		1	3.3		1	3.37		1
	PYRUVIC ACID	ND	U	1	ND	U	1	ND	U	1	ND	U	1
	VALERIC ACID	ND	U	1	ND	U	1	ND	U	1	ND	U	1
Fluorometric (µg/L) Spectrofluorophotometry	FLUORESCEIN	5.154		0.01	NS	--	--	NS	--	--	NS	--	--
Reduced Gases (µg/L) RSKSOP-175	ACETYLENE	ND	U	10	ND	U	10	ND	U	10	ND	U	10
	ETHANE	1.76	J	4	1.56	J	4	1.65	J	4	2.25	J	4
	ETHYLENE	1.81	J	5	3.1	J	5	3.2	J	5	3.92	J	5
	METHANE	1.46	J	2	1.6	J	2	1.89	J	2	2.15		2
	PROPANE	ND	U	6	ND	U	6	ND	U	6	ND	U	6
General Chemistry (mg/L) SM2320b, EPA Method 300, EPA Method 353.2, SM4500 Pe ^c	ALKALINITY	329		1	350		1	354		1	354		1
	BROMIDE	0.434	J	0.25	0.848		0.25	0.844		0.25	0.873		0.25
	CHLORIDE	39		0.66	87.5		0.66	87.2		0.66	91.2		0.66
	IODIDE	ND	U	0.75	0.82	J	0.75	0.83	J	0.75	ND	U	0.75
	NITRATE	NS	--	--	NS	--	--	NS	--	--	NS	--	--
	NITRITE	NS	--	--	NS	--	--	NS	--	--	NS	--	--
	NITROGEN, NITRATE-NITRITE	ND	U	0.375	ND	U	0.375	ND	U	0.375	ND	U	0.375
	O-PHOSPHATE (AS P)	ND	U	0.02	0.0172	J	0.02	0.0136	J	0.02	ND	U	0.02
	ORTHOPHOSPHATE	NS	--	--	NS	--	--	NS	--	--	NS	--	--
	PHOSPHORUS	NS	--	--	NS	--	--	NS	--	--	NS	--	--
Metals (mg/L) EPA Method 6010	SULFATE	12.9		2	23.5	J+	2	24	J+	2	20.9		2
	LEAD	NS	--	--	NS	--	--	NS	--	--	NS	--	--

Table 10
Analytical Data Table for KAFB-106EX2

Phase Designation		Phase 1 Passive			Phase 2 Recirculation								
Sample ID		106EX2-P1P-112917			106EX2-P2R-011018			106EX2-P2R-011018-FD			106EX2-P2R-011618		
Sample Date		11/29/2017			1/10/2018			1/10/2018			1/16/2018		
Sample Purpose		REG			REG			FD			REG		
Chemical Class and Analytical Method ^a	Parameter	Result	Val Qual	LOQ	Result	Val Qual	LOQ	Result	Val Qual	LOQ	Result	Val Qual	LOQ
Dissolved Metals (mg/L) EPA Method 6010	IRON	1.03		0.06	0.352		0.06	0.356		0.06	0.358		0.06
	MANGANESE	2.93		0.006	2.87		0.006	2.87		0.006	3.01		0.006
δ2H (‰) Mass Spectrometry, USGS Reston, VA	DELTA2H	-86.95		-99	NS	--	--	NS	--	--	NS	--	--
CSIA EDB δ13C (‰) Kuder et al, 2012	EDB δ	-17.3 ±2‰	--	--	NS	--	--	NS	--	--	NS	--	--
VOCs (µg/L) EPA Method 8260	1,1,2-TRICHLOROETHANE	ND	U	25	ND	U	50	ND	U	50	ND	U	50
	1,2,4-TRICHLOROBENZENE	NS	--	--	NS	--	--	NS	--	--	NS	--	--
	1,2,4-TRIMETHYLBENZENE	180		25	256		50	273		50	272		50
	1,2-DIBROMOETHANE	133		25	118		50	112		50	117		50
	1,2-DICHLOROETHANE	ND	U	25	ND	U	50	ND	U	50	ND	U	50
	1,3,5-TRIMETHYLBENZENE	67.4		25	89.8	J	50	93	J	50	96.6	J	50
	2-BUTANONE	236	J	250	ND	U	500	ND	U	500	ND	U	500
	2-CHLOROTOLUENE	ND	U	25	ND	U	50	ND	U	50	ND	U	50
	2-HEXANONE	278		125	231	J	250	197	J	250	162	J	250
	4-METHYL-2-PENTANONE	165	J	125	ND	U	250	ND	U	250	ND	U	250
	ACETONE	1080		250	954	J	500	829	J	500	668	J	500
	BENZENE	3660		25	4260		50	4240		50	4070		50
	CARBON DISULFIDE	ND	U	25	ND	U	50	ND	U	50	ND	U	50
	CHLOROMETHANE	ND	U	25	50.5		50	61.6		50	ND	U	50
	CIS-1,2-DICHLOROETHENE	NA	--	--	NA	--	--	NA	--	--	NA	--	--
	DICHLORODIFLUOROMETHANE	ND	U	50	ND	U	100	ND	U	100	ND	U	100
	ETHYLBENZENE	689		25	882		50	871		50	855		50
	ISOPROPYLBENZENE	56.9		25	66.3	J	50	66.9	J	50	66.4	J	50
	M,P-XYLENES	NA	--	--	NA	--	--	NA	--	--	NA	--	--
	METHYL TERT-BUTYL ETHER	ND	U	25	ND	U	50	ND	U	50	ND	U	50
	METHYLENE CHLORIDE	ND	U	50	58	J	100	50.4	J	100	ND	U	100
	NAPHTHALENE	89.2		25	101		50	91.5		50	95.3	J	50
	N-BUTYLBENZENE	ND	U	25	ND	U	50	ND	U	50	ND	U	50
	N-PROPYLBENZENE	58.6		25	69.2	J	50	67.8	J	50	65.6	J	50
	O-XYLENE	NA	--	--	NA	--	--	NA	--	--	NA	--	--
	P-ISOPROPYLTOLUENE	14.6	J	25	28.6	J	50	27.6	J	50	25.9	J	50
	SEC-BUTYLBENZENE	12.5	J	25	ND	U	50	ND	U	50	ND	U	50
	TERT-BUTYLBENZENE	ND	U	25	ND	U	50	ND	U	50	ND	U	50
	TETRACHLOROETHENE	NA	--	--	NA	--	--	NA	--	--	NA	--	--
	TOLUENE	6940		25	8070		50	8110		50	8410		50
	TRANS-1,2-DICHLOROETHENE	NA	--	--	NA	--	--	NA	--	--	NA	--	--
	TRICHLOROETHENE	ND	U	25	ND	U	50	ND	U	50	ND	U	50
	TRICHLOROFLUOROMETHANE	ND	U	50	ND	U	100	ND	U	100	ND	U	100
	VINYL CHLORIDE	NA	--	--	NA	--	--	NA	--	--	NA	--	--
	XYLENES	2330		75	2870		150	2880		150	2680		150

Refer to notes at the end of the table.

Table 10
Analytical Data Table for KAFB-106EX2

Phase Designation		Phase 2 Recirculation			Phase 2 Passive			Phase 2 Passive			Phase 2 Passive		
Sample ID		106EX2-P2R-012518			106EX2-P2P-030718			106EX2-P2P-041118			106EX2-P2P-050918		
Sample Date		1/25/2018			3/7/2018			4/11/2018			5/9/2018		
Sample Purpose		REG			REG			REG			REG		
Chemical Class and Analytical Method ^a	Parameter	Result	Val Qual	LOQ	Result	Val Qual	LOQ	Result	Val Qual	LOQ	Result	Val Qual	LOQ
Microbial Community (cells/mL) QuantArray-Chlor	1,1 DCA Reductase (DCA)	ND	U	17.9	NS	--	--	NS	--	--	ND	U	9.1
	1,2 DCA Reductase (DCAR)	ND	U	17.9	NS	--	--	NS	--	--	ND	U	9.1
	BAV1 Vinyl Chloride Reductase (BVC)	ND	U	1.8	NS	--	--	NS	--	--	ND	U	0.9
	cer A Reductase	ND	U	17.9	NS	--	--	NS	--	--	ND	U	9.1
	Chloroform Reductase (CFR)	ND	U	17.9	NS	--	--	NS	--	--	ND	U	9.1
	Dehalobacter DCM (DCM)	ND	U	17.9	NS	--	--	NS	--	--	990		9.1
	Dehalobacter spp. (DHBt)	321000		17.9	NS	--	--	NS	--	--	140000		9.1
	Dehalobium chloro-coercia (DECO)	33700		17.9	NS	--	--	NS	--	--	18300		9.1
	Dehalococcoides (DHC)	ND	U	1.8	NS	--	--	NS	--	--	ND	U	0.9
	Dehalogenimonas spp. (DHG)	ND	U	17.9	NS	--	--	NS	--	--	1110		9.1
	Desulfitobacterium spp. (DSB)	414000		17.9	NS	--	--	NS	--	--	57000		9.1
	Desulfuromonas spp. (DSM)	67.9		17.9	NS	--	--	NS	--	--	19900		9.1
	Dichloromethane Dehalogenase (DCMA)	ND	U	17.9	NS	--	--	NS	--	--	ND	U	9.1
	Epoxyalkane Transferase (EtnE)	ND	U	17.9	NS	--	--	NS	--	--	ND	U	9.1
	Ethene Monooxygenase (EtnC)	ND	U	17.9	NS	--	--	NS	--	--	ND	U	9.1
	Methanogens (MGN)	15.5	J	17.9	NS	--	--	NS	--	--	33.9		9.1
	PCE Reductase (PCE-1)	ND	U	17.9	NS	--	--	NS	--	--	ND	U	9.1
	Phenol Hydroxylase (PHE)	74600		17.9	NS	--	--	NS	--	--	33600		9.1
	PMMO	NA	--	--	NS	--	--	NS	--	--	NA	--	--
	Soluble Methane Monooxygenase (SMMO)	ND	U	17.9	NS	--	--	NS	--	--	ND	U	9.1
	Sulfate Reducing Bacteria (APS)	380000		17.9	NS	--	--	NS	--	--	46400		9.1
	tceA Reductase (TCE)	ND	U	1.8	NS	--	--	NS	--	--	ND	U	0.9
	Toluene Dioxygenase (TOD)	ND	U	17.9	NS	--	--	NS	--	--	ND	U	9.1
Toluene Monooxygenase (RMO)	83200		17.9	NS	--	--	NS	--	--	25000		9.1	
Toluene Monooxygenase 2 (RDEG)	79800		17.9	NS	--	--	NS	--	--	18800		9.1	
Total Eubacteria (EBAC)	28900000		17.9	NS	--	--	NS	--	--	10800000		9.1	
trans-1,2-DCE Reductase (TDR)	ND	U	17.9	NS	--	--	NS	--	--	ND	U	9.1	
Trichlorobenzene Dioxygenase (TCBO)	934		17.9	NS	--	--	NS	--	--	ND	U	9.1	
Vinyl Chloride Reductase (VCR)	ND	U	1.8							ND	U	0.9	
EDB (µg/L) EPA Method 8011	1,2-DIBROMOETHANE	90.9	J+	9.62	94.8	J+	9.52	69	J	9.59	92.5		3.85
VFAs (mg/L) EPA Method 300m	ACETIC ACID	26.1		1	11.5		1	9.5		1	11		1
	BUTYRIC ACID	ND	U	1	ND	U	1	ND	U	1	ND	U	1
	FORMIC ACID	ND	U	1	ND	U	1	ND	U	1	ND	U	1
	LACTIC ACID	1.64		1	ND	U	1	0.65		1	1	J	1
	PROPIONIC ACID	6.86		1	2.2		1	1		1	ND	U	1
	PYRUVIC ACID	ND	U	1	ND	U	1	ND	U	1	ND	U	1
	VALERIC ACID	ND	U	1	ND	U	1	ND	U	1	ND	U	1
Fluorometric (µg/L) Spectrofluorophotometry	FLUORESCEIN	NS	--	--	NS	--	--	NS	--	--	NS	--	--
Reduced Gases (µg/L) RSKSOP-175	ACETYLENE	ND	U	10	ND	U	10	ND	U	10	ND	U	10
	ETHANE	2.41	J	4	3.2	J	4	5.1		4	6.8		4
	ETHYLENE	4.7	J	5	5.3		5	7.05		5	9.6		5
	METHANE	2.64		2	6.9		2	15.2		2	30.4		2
	PROPANE	2.42	J	6	3.1	J	6	5.9	J	6	8.6		6
General Chemistry (mg/L) SM2320b, EPA Method 300, EPA Method 353.2, SM4500 Pe ^c	ALKALINITY	363		1	377		1	380		1	373		1
	BROMIDE	0.764		0.125	0.92	J	0.625	1.02		0.25	1.14		0.25
	CHLORIDE	76.2		0.66	107		1.65	130		0.66	143		0.66
	IODIDE	2.7		0.75	1.6		0.75	0.57	J	0.75	0.31	J	0.75
	NITRATE	NS	--	--	NS	--	--	ND	U	0.2	ND	U	0.2
	NITRITE	NS	--	--	NS	--	--	ND	U	0.2	ND	U	0.2
	NITROGEN, NITRATE-NITRITE	ND	U	0.375	ND	U	0.375	NS	--	--	NS	--	--
	O-PHOSPHATE (AS P)	ND	U	0.02	0.0131	J	0.02	0.0202		0.02	0.0382	J	0.02
	ORTHOPHOSPHATE	NS	--	--	NS	--	--	NS	--	--	NS	--	--
	PHOSPHORUS	NS	--	--	NS	--	--	NS	--	--	NS	--	--
SULFATE	19.4		2	32.1		5	38.5		2	39.7		2	
Metals (mg/L) EPA Method 6010	LEAD	NS	--	--	NS	--	--	NS	--	--	NS	--	--

Table 10
Analytical Data Table for KAFB-106EX2

Phase Designation		Phase 2 Recirculation			Phase 2 Passive								
Sample ID		106EX2-P2R-012518			106EX2-P2P-030718			106EX2-P2P-041118			106EX2-P2P-050918		
Sample Date		1/25/2018			3/7/2018			4/11/2018			5/9/2018		
Sample Purpose		REG			REG			REG			REG		
Chemical Class and Analytical Method ^a	Parameter	Result	Val Qual	LOQ	Result	Val Qual	LOQ	Result	Val Qual	LOQ	Result	Val Qual	LOQ
Dissolved Metals (mg/L) EPA Method 6010	IRON	0.403	J-	0.06	2.19		0.06	2.44	J-	0.06	3.82		0.06
	MANGANESE	2.96	J-	0.006	4.11		0.006	4.86	J+	0.006	5.02		0.006
δ2H (‰) Mass Spectrometry, USGS Reston, VA	DELTA2H	NS	--	--	NS	--	--	NS	--	--	NS	--	--
CSIA EDB δ13C (‰) Kuder et al, 2012	EDB δ	-17.1 ±2‰	--	--	NS	--	--	NS	--	--	-17.9 ±1‰	--	--
VOCs (µg/L) EPA Method 8260	1,1,2-TRICHLOROETHANE	ND	U	50	ND	U	50	ND	U	50	ND	U	50
	1,2,4-TRICHLOROBENZENE	NS	--	--	NS	--	--	NS	--	--	NS	--	--
	1,2,4-TRIMETHYLBENZENE	301		50	251		50	306		50	301		50
	1,2-DIBROMOETHANE	122		50	116		50	96.9	J	50	94.8	J	50
	1,2-DICHLOROETHANE	ND	U	50	ND	U	50	ND	U	50	ND	U	50
	1,3,5-TRIMETHYLBENZENE	110		50	84.2	J	50	109		50	103		50
	2-BUTANONE	ND	U	500	ND	U	500	ND	U	500	ND	U	500
	2-CHLOROTOLUENE	ND	U	50	ND	U	50	ND	U	50	ND	U	50
	2-HEXANONE	191	J	250	200	J+	250	254	J	250	245	J	250
	4-METHYL-2-PENTANONE	ND	U	250	136	J	250	177	J	250	146	J	250
	ACETONE	643	J	500	788	J	500	877	J	500	498	J	500
	BENZENE	4250		50	4180		50	3940		50	4170		50
	CARBON DISULFIDE	ND	U	50	ND	U	50	ND	U	50	ND	U	50
	CHLOROMETHANE	ND	U	50	ND	U	50	ND	U	50	ND	U	50
	CIS-1,2-DICHLOROETHENE	NA	--	--	NA	--	--	NA	--	--	NA	--	--
	DICHLORODIFLUOROMETHANE	ND	U	100	ND	U	100	ND	U	100	ND	U	100
	ETHYLBENZENE	994		50	923		50	954		50	898		50
	ISOPROPYLBENZENE	74.4	J	50	91.7	J	50	109		50	104		50
	M,P-XYLENES	NA	--	--	NA	--	--	NA	--	--	NA	--	--
	METHYL TERT-BUTYL ETHER	ND	U	50	ND	U	50	ND	U	50	ND	U	50
	METHYLENE CHLORIDE	ND	U	100	ND	U	100	ND	U	100	ND	U	100
	NAPHTHALENE	101		50	82.5	J	50	126		50	130		50
	N-BUTYLBENZENE	ND	U	50	ND	U	50	ND	U	50	ND	U	50
	N-PROPYLBENZENE	86.8	J	50	73.3	J	50	90.5	J	50	86.4	J	50
	O-XYLENE	NA	--	--	NA	--	--	NA	--	--	NA	--	--
	P-ISOPROPYLTOLUENE	ND	U	50	ND	U	50	39.9	J	50	45.1	J	50
	SEC-BUTYLBENZENE	ND	U	50	ND	U	50	ND	U	50	ND	U	50
	TERT-BUTYLBENZENE	ND	U	50	ND	U	50	ND	U	50	ND	U	50
	TETRACHLOROETHENE	NA	--	--	NA	--	--	NA	--	--	NA	--	--
	TOLUENE	9530		50	8630		50	7640		50	7640		50
	TRANS-1,2-DICHLOROETHENE	NA	--	--	NA	--	--	NA	--	--	NA	--	--
	TRICHLOROETHENE	ND	U	50	ND	U	50	ND	U	50	ND	U	50
	TRICHLOROFLUOROMETHANE	ND	U	100	ND	U	100	ND	U	100	ND	U	100
	VINYL CHLORIDE	NA	--	--	NA	--	--	NA	--	--	NA	--	--
	XYLENES	3020		150	2850		150	2910		150	2950		150

Refer to notes at the end of the table.

Table 10
Analytical Data Table for KAFB-106EX2

Phase Designation		Phase 2 Passive			Phase 3 Recirculation								
Sample ID		106EX2-P2P-061418			106EX2-P3R-080818			106EX2-P3R-080818-FD			106EX2-P3R-081618		
Sample Date		6/14/2018			8/8/2018			8/8/2018			8/16/2018		
Sample Purpose		REG			REG			FD			REG		
Chemical Class and Analytical Method ^a	Parameter	Result	Val Qual	LOQ	Result	Val Qual	LOQ	Result	Val Qual	LOQ	Result	Val Qual	LOQ
Microbial Community (cells/mL) QuantArray-Chlor	1,1 DCA Reductase (DCA)	NS	--	--	NS	--	--	NS	--	--	NS	--	--
	1,2 DCA Reductase (DCAR)	NS	--	--	NS	--	--	NS	--	--	NS	--	--
	BAV1 Vinyl Chloride Reductase (BVC)	NS	--	--	NS	--	--	NS	--	--	NS	--	--
	cer A Reductase	NS	--	--	NS	--	--	NS	--	--	NS	--	--
	Chloroform Reductase (CFR)	NS	--	--	NS	--	--	NS	--	--	NS	--	--
	Dehalobacter DCM (DCM)	NS	--	--	NS	--	--	NS	--	--	NS	--	--
	Dehalobacter spp. (DHBt)	NS	--	--	NS	--	--	NS	--	--	NS	--	--
	Dehalobium chloroeracia (DECO)	NS	--	--	NS	--	--	NS	--	--	NS	--	--
	Dehalococcoides (DHC)	NS	--	--	NS	--	--	NS	--	--	NS	--	--
	Dehalogenimonas spp. (DHG)	NS	--	--	NS	--	--	NS	--	--	NS	--	--
	Desulfotobacterium spp. (DSB)	NS	--	--	NS	--	--	NS	--	--	NS	--	--
	Desulfuromonas spp. (DSM)	NS	--	--	NS	--	--	NS	--	--	NS	--	--
	Dichloromethane Dehalogenase (DCMA)	NS	--	--	NS	--	--	NS	--	--	NS	--	--
	Epoxyalkane Transferase (EtnE)	NS	--	--	NS	--	--	NS	--	--	NS	--	--
	Ethene Monooxygenase (EtnC)	NS	--	--	NS	--	--	NS	--	--	NS	--	--
	Methanogens (MGN)	NS	--	--	NS	--	--	NS	--	--	NS	--	--
	PCE Reductase (PCE-1)	NS	--	--	NS	--	--	NS	--	--	NS	--	--
	Phenol Hydroxylase (PHE)	NS	--	--	NS	--	--	NS	--	--	NS	--	--
	PMMO	NS	--	--	NS	--	--	NS	--	--	NS	--	--
	Soluble Methane Monooxygenase (SMMO)	NS	--	--	NS	--	--	NS	--	--	NS	--	--
	Sulfate Reducing Bacteria (APS)	NS	--	--	NS	--	--	NS	--	--	NS	--	--
	tceA Reductase (TCE)	NS	--	--	NS	--	--	NS	--	--	NS	--	--
	Toluene Dioxygenase (TOD)	NS	--	--	NS	--	--	NS	--	--	NS	--	--
Toluene Monooxygenase (RMO)	NS	--	--	NS	--	--	NS	--	--	NS	--	--	
Toluene Monooxygenase 2 (RDEG)	NS	--	--	NS	--	--	NS	--	--	NS	--	--	
Total Eubacteria (EBAC)	NS	--	--	NS	--	--	NS	--	--	NS	--	--	
trans-1,2-DCE Reductase (TDR)	NS	--	--	NS	--	--	NS	--	--	NS	--	--	
Trichlorobenzene Dioxygenase (TCBO)	NS	--	--	NS	--	--	NS	--	--	NS	--	--	
Vinyl Chloride Reductase (VCR)	NS	--	--	NS	--	--	NS	--	--	NS	--	--	
EDB (µg/L) EPA Method 8011	1,2-DIBROMOETHANE	101		3.83	82		0.3	74		0.31	82		0.31
VFAs (mg/L) EPA Method 300m	ACETIC ACID	8	J	1	13.9		1	14		1	23.5		10
	BUTYRIC ACID	ND	UJ	1	ND	U	1	ND	U	1	ND	U	1
	FORMIC ACID	ND	UJ	1	ND	U	1	ND	U	1	ND	U	1
	LACTIC ACID	0.6	J	1	ND	U	1	ND	U	1	0.7	J	1
	PROPIONIC ACID	ND	UJ	1	ND	U	1	ND	U	1	ND	U	1
	PYRUVIC ACID	ND	UJ	1	ND	U	1	ND	U	1	ND	U	1
	VALERIC ACID	ND	UJ	1	ND	U	1	ND	U	1	ND	U	1
Fluorometric (µg/L) Spectrofluorophotometry	FLUORESCEIN	NS	--	--	NS	--	--	NS	--	--	NS	--	--
Reduced Gases (µg/L) RSKSOP-175	ACETYLENE	ND	UJ	10	ND	U	10	ND	U	10	ND	U	10
	ETHANE	6.9	J	4	4.9		4	4.8		4	4.7		4
	ETHYLENE	11.4	J	5	9		5	8.5		5	7.9		5
	METHANE	15.5	J	2	10.3		2	10		2	28.2		2
	PROPANE	9.4	J	6	5.3	J	6	5.4	J	6	5.3	J	6
General Chemistry (mg/L) SM2320b, EPA Method 300, EPA Method 353.2, SM4500 Pe ^c	ALKALINITY	419	J-	1	380		5	370		5	380		5
	BROMIDE	1.06	J	0.625	1.7		1	1.7		1	1.2		0.5
	CHLORIDE	136		1.65	91		1	90		1	88		0.5
	IODIDE	0.47	J	0.75	3.9		0.75	4.8		0.75	4.2		0.75
	NITRATE	ND	U	0.5	NS	--	--	NS	--	--	NS	--	--
	NITRITE	ND	U	0.5	NS	--	--	NS	--	--	NS	--	--
	NITROGEN, NITRATE-NITRITE	NS	--	--	ND	R	0.05	ND	R	0.05	ND	U	0.05
	O-PHOSPHATE (AS P)	0.0185		0.02	NS	--	--	NS	--	--	NS	--	--
	ORTHOPHOSPHATE	NS	--	--	ND	R	0.15	ND	R	0.15	ND	U	0.15
	PHOSPHORUS	NS	--	--	NS	--	--	NS	--	--	NS	--	--
SULFATE	35.8		5	28		2	28		2	26		1	
Metals (mg/L) EPA Method 6010	LEAD	NS	--	--	NS	--	--	NS	--	--	NS	--	--

Table 10
Analytical Data Table for KAFB-106EX2

Phase Designation		Phase 2 Passive			Phase 3 Recirculation								
Sample ID		106EX2-P2P-061418			106EX2-P3R-080818			106EX2-P3R-080818-FD			106EX2-P3R-081618		
Sample Date		6/14/2018			8/8/2018			8/8/2018			8/16/2018		
Sample Purpose		REG			REG			FD			REG		
Chemical Class and Analytical Method ^a	Parameter	Result	Val Qual	LOQ	Result	Val Qual	LOQ	Result	Val Qual	LOQ	Result	Val Qual	LOQ
Dissolved Metals (mg/L) EPA Method 6010	IRON	4.21		0.06	1.1		0.05	1.2		0.05	1.1		0.05
	MANGANESE	5.24		0.006	4.4		0.003	4.7		0.003	4.8		0.003
δ2H (‰) Mass Spectrometry, USGS Reston, VA	DELTA2H	NS	--	--	NS	--	--	NS	--	--	NS	--	--
CSIA EDB δ13C (‰) Kuder et al, 2012	EDB δ	NS	--	--	NS	--	--	NS	--	--	NS	--	--
VOCs (µg/L) EPA Method 8260	1,1,2-TRICHLOROETHANE	ND	U	25	ND	U	0.5	ND	U	0.5	ND	U	10
	1,2,4-TRICHLOROBENZENE	NS	--	--	NS	--	--	NS	--	--	NS	--	--
	1,2,4-TRIMETHYLBENZENE	367		25	230		20	230		20	260		20
	1,2-DIBROMOETHANE	91		25	78	J+	1	85	J+	1	85		20
	1,2-DICHLOROETHANE	ND	U	25	ND	U	1	ND	U	1	ND	U	20
	1,3,5-TRIMETHYLBENZENE	124		25	86	J+	0.5	88	J+	0.5	89		10
	2-BUTANONE	180	J	250	130	J+	10	130	J+	10	110	J	200
	2-CHLOROTOLUENE	ND	U	25	ND	U	0.5	ND	U	0.5	ND	U	10
	2-HEXANONE	259		125	160	J+	5	160	J+	5	150	J	100
	4-METHYL-2-PENTANONE	129	J	125	98	J+	5	99	J+	5	90	J	100
	ACETONE	561		250	480	J+	10	490	J+	10	430		200
	BENZENE	4360		25	3300		20	3500		20	3600		20
	CARBON DISULFIDE	ND	U	25	ND	U	2	ND	U	2	ND	U	40
	CHLOROMETHANE	ND	U	25	ND	U	1	ND	U	1	ND	U	20
	CIS-1,2-DICHLOROETHENE	NA	--	--	NA	--	--	NA	--	--	NA	--	--
	DICHLORODIFLUOROMETHANE	ND	U	50	ND	U	1	ND	U	1	ND	U	20
	ETHYLBENZENE	1070		25	770		20	770		20	870		20
	ISOPROPYLBENZENE	118		25	70	J+	1	71	J+	1	74		20
	M,P-XYLENES	NA	--	--	NA	--	--	NA	--	--	NA	--	--
	METHYL TERT-BUTYL ETHER	ND	U	25	ND	U	0.5	ND	U	0.5	ND	U	10
	METHYLENE CHLORIDE	28.4	J	50	ND	U	5	ND	U	5	ND	U	100
	NAPHTHALENE	138		25	120	J+	5	130	J+	5	120		100
	N-BUTYLBENZENE	18.9	J	25	12	J+	1	13	J+	1	12	J	20
	N-PROPYLBENZENE	113		25	69	J+	1	71	J+	1	75		20
	O-XYLENE	NA	--	--	NA	--	--	NA	--	--	NA	--	--
	P-ISOPROPYLTOLUENE	ND	U	25	32	J+	1	33	J+	1	30		20
	SEC-BUTYLBENZENE	21.9	J	25	13	J+	1	13	J+	1	13	J	20
	TERT-BUTYLBENZENE	ND	U	25	1.2	J+	1	1.1	J+	1	ND	U	20
TETRACHLOROETHENE	NA	--	--	NA	--	--	NA	--	--	NA	--	--	
TOLUENE	8030		25	7600	J-	100	7100	J-	100	9100		100	
TRANS-1,2-DICHLOROETHENE	NA	--	--	NA	--	--	NA	--	--	NA	--	--	
TRICHLOROETHENE	ND	U	25	ND	U	1	ND	U	1	ND	U	20	
TRICHLOROFLUOROMETHANE	ND	U	50	ND	U	1	ND	U	1	ND	U	20	
VINYL CHLORIDE	NA	--	--	NA	--	--	NA	--	--	NA	--	--	
XYLENES	3670		75	2400		10	2400		10	2800		10	

Refer to notes at the end of the table.

Table 10
Analytical Data Table for KAFB-106EX2

Phase Designation		Phase 3 Recirculation						Phase 3 Passive					
Sample ID		106EX2-P3R-082218			106EX2-P3R-082918			106EX2-P3P-091218			106EX2-P3P-100418		
Sample Date		8/22/2018			8/29/2018			9/12/2018			10/4/2018		
Sample Purpose		REG			REG			REG			REG		
Chemical Class and Analytical Method ^a	Parameter	Result	Val Qual	LOQ	Result	Val Qual	LOQ	Result	Val Qual	LOQ	Result	Val Qual	LOQ
Microbial Community (cells/mL) QuantArray-Chlor	1,1 DCA Reductase (DCA)	ND	U	4.9	NS	--	--	NS	--	--	NS	--	--
	1,2 DCA Reductase (DCAR)	ND	U	4.9	NS	--	--	NS	--	--	NS	--	--
	BAV1 Vinyl Chloride Reductase (BVC)	ND	U	0.5	NS	--	--	NS	--	--	NS	--	--
	cer A Reductase	ND	U	4.9	NS	--	--	NS	--	--	NS	--	--
	Chloroform Reductase (CFR)	ND	U	4.9	NS	--	--	NS	--	--	NS	--	--
	Dehalobacter DCM (DCM)	ND	U	4.9	NS	--	--	NS	--	--	NS	--	--
	Dehalobacter spp. (DHBt)	248000		4.9	NS	--	--	NS	--	--	NS	--	--
	Dehalobium chloro-coercia (DECO)	13000		4.9	NS	--	--	NS	--	--	NS	--	--
	Dehalococcoides (DHC)	ND	U	0.5	NS	--	--	NS	--	--	NS	--	--
	Dehalogenimonas spp. (DHG)	ND	U	4.9	NS	--	--	NS	--	--	NS	--	--
	Desulfitobacterium spp. (DSB)	62800		4.9	NS	--	--	NS	--	--	NS	--	--
	Desulfuromonas spp. (DSM)	ND	U	4.9	NS	--	--	NS	--	--	NS	--	--
	Dichloromethane Dehalogenase (DCMA)	ND	U	4.9	NS	--	--	NS	--	--	NS	--	--
	Epoxyalkane Transferase (EtnE)	ND	U	4.9	NS	--	--	NS	--	--	NS	--	--
	Ethene Monooxygenase (EtnC)	ND	U	4.9	NS	--	--	NS	--	--	NS	--	--
	Methanogens (MGN)	529		4.9	NS	--	--	NS	--	--	NS	--	--
	PCE Reductase (PCE-1)	ND	U	4.9	NS	--	--	NS	--	--	NS	--	--
	Phenol Hydroxylase (PHE)	10900		4.9	NS	--	--	NS	--	--	NS	--	--
	PMMO	NA	--	--	NS	--	--	NS	--	--	NS	--	--
	Soluble Methane Monooxygenase (SMMO)	2040		4.9	NS	--	--	NS	--	--	NS	--	--
	Sulfate Reducing Bacteria (APS)	197000		4.9	NS	--	--	NS	--	--	NS	--	--
	tceA Reductase (TCE)	ND	U	0.5	NS	--	--	NS	--	--	NS	--	--
	Toluene Dioxygenase (TOD)	ND	U	4.9	NS	--	--	NS	--	--	NS	--	--
Toluene Monooxygenase (RMO)	32100		4.9	NS	--	--	NS	--	--	NS	--	--	
Toluene Monooxygenase 2 (RDEG)	6480		4.9	NS	--	--	NS	--	--	NS	--	--	
Total Eubacteria (EBAC)	9990000		4.9	NS	--	--	NS	--	--	NS	--	--	
trans-1,2-DCE Reductase (TDR)	ND	U	4.9	NS	--	--	NS	--	--	NS	--	--	
Trichlorobenzene Dioxygenase (TCBO)	ND	U	4.9	NS	--	--	NS	--	--	NS	--	--	
Vinyl Chloride Reductase (VCR)	ND	U	0.5	NS	--	--	NS	--	--	NS	--	--	
EDB (µg/L) EPA Method 8011	1,2-DIBROMOETHANE	47		0.0003	97		0.3	60		0.29	65		0.15
VFAs (mg/L) EPA Method 300m	ACETIC ACID	27.7		10	30.5		10	43.7		10	30.8		10
	BUTYRIC ACID	ND	U	1	ND	U	1	ND	U	1	ND	U	1
	FORMIC ACID	ND	U	1	ND	U	1	ND	U	1	ND	U	1
	LACTIC ACID	0.6	J	1	ND	U	1	1		1	0.6	J	1
	PROPIONIC ACID	ND	U	1	7.3		1	10.8		1	ND	U	1
	PYRUVIC ACID	ND	U	1	ND	U	1	ND	U	1	ND	U	1
	VALERIC ACID	ND	U	1	ND	U	1	ND	U	1	ND	U	1
Fluorometric (µg/L) Spectrofluorophotometry	FLUORESCEIN	NS	--	--	NS	--	--	NS	--	--	NS	--	--
Reduced Gases (µg/L) RSKSOP-175	ACETYLENE	ND	U	10	ND	U	10	ND	U	10	ND	U	10
	ETHANE	4.5		4	4.5		4	4.7		4	6.7		4
	ETHYLENE	8.1		5	8.5		5	9.8		5	13.1		5
	METHANE	57.7		2	105.5		2	279.7		2	398.5		2
	PROPANE	5.1	J	6	5.1	J	6	5.5	J	6	7.8		6
General Chemistry (mg/L) SM2320b, EPA Method 300, EPA Method 353.2, SM4500 Pe ^c	ALKALINITY	400		5	400		5	410		5	400		5
	BROMIDE	1.1		0.5	1.1		0.5	0.99		0.5	2		0.5
	CHLORIDE	85		0.5	87		0.5	88		0.5	96		0.5
	IODIDE	5.8		0.75	4.6		0.75	4.9		0.75	2.3		0.75
	NITRATE	NS	--	--	NS	--	--	NS	--	--	NS	--	--
	NITRITE	NS	--	--	NS	--	--	NS	--	--	NS	--	--
	NITROGEN, NITRATE-NITRITE	ND		0.05	ND	U	0.05	0.11		0.05	ND	U	0.05
	O-PHOSPHATE (AS P)	NS	--	--	NS	--	--	NS	--	--	NS	--	--
	ORTHOPHOSPHATE	ND		0.15	ND	U	0.15	ND	U	0.15	ND	U	0.15
	PHOSPHORUS	NS	--	--	NS	--	--	NS	--	--	NS	--	--
SULFATE	24		1	23		1	18		1	20		1	
Metals (mg/L) EPA Method 6010	LEAD	NS	--	--	NS	--	--	NS	--	--	NS	--	--

Table 10
Analytical Data Table for KAFB-106EX2

Phase Designation		Phase 3 Recirculation						Phase 3 Passive					
Sample ID		106EX2-P3R-082218			106EX2-P3R-082918			106EX2-P3P-091218			106EX2-P3P-100418		
Sample Date		8/22/2018			8/29/2018			9/12/2018			10/4/2018		
Sample Purpose		REG			REG			REG			REG		
Chemical Class and Analytical Method ^a	Parameter	Result	Val Qual	LOQ	Result	Val Qual	LOQ	Result	Val Qual	LOQ	Result	Val Qual	LOQ
Dissolved Metals (mg/L)	IRON	1.2		0.05	1.1		0.05	1.6		0.05	3.7		0.05
EPA Method 6010	MANGANESE	4.9		0.003	5.2		0.003	5.6		0.003	5.8		0.003
δ2H (‰)	DELTA2H	NS	--	--	NS	--	--	NS	--	--	NS	--	--
Mass Spectrometry, USGS Reston, VA													
CSIA EDB δ13C (‰)	EDB δ	-19.2 ±1.5‰	--	--	NS	--	--	-18.0 ±1.5‰	--	--	NS	--	--
Kuder et al, 2012													
VOCs (µg/L)	1,1,2-TRICHLOROETHANE	ND	U	50	ND	U	0.5	ND	U	50	ND	U	50
EPA Method 8260	1,2,4-TRICHLOROBENZENE	NS	--	--	NS	--	--	NS	--	--	NS	--	--
	1,2,4-TRIMETHYLBENZENE	310		100	290		100	260		100	340		100
	1,2-DIBROMOETHANE	ND	U	100	78	J+	1	73	J	100	ND	U	100
	1,2-DICHLOROETHANE	ND	U	100	3.5		1	ND	U	100	ND	U	100
	1,3,5-TRIMETHYLBENZENE	110		50	92	J+	0.5	94	J	50	110		50
	2-BUTANONE	ND	U	1000	130	J+	10	ND	U	1000	ND	U	1000
	2-CHLOROTOLUENE	ND	U	50	ND	U	0.5	ND	U	50	ND	U	50
	2-HEXANONE	ND	U	500	140	J+	5	ND	U	500	200	J	500
	4-METHYL-2-PENTANONE	ND	U	500	94	J+	5	ND	U	500	ND	U	500
	ACETONE	ND	U	1000	490	J+	10	ND	U	1000	ND	U	1000
	BENZENE	4400		100	4200		100	4000		100	3800		100
	CARBON DISULFIDE	ND	U	200	ND	U	2	ND	U	200	ND	U	200
	CHLOROMETHANE	ND	U	100	ND	U	1	ND	U	100	ND	U	100
	CIS-1,2-DICHLOROETHENE	NA	--	--	NA	--	--	NA	--	--	NA	--	--
	DICHLORODIFLUOROMETHANE	ND	U	100	ND	U	1	ND	U	100	ND	U	100
	ETHYLBENZENE	1000		100	1000		100	940		100	960		100
	ISOPROPYLBENZENE	94	J	100	78	J+	1	85	J	100	120		100
	M,P-XYLENES	NA	--	--	NA	--	--	NA	--	--	NA	--	--
	METHYL TERT-BUTYL ETHER	ND	U	50	ND	U	0.5	ND	U	50	ND	U	50
	METHYLENE CHLORIDE	ND	U	500	ND	U	5	ND	U	500	ND	U	500
	NAPHTHALENE	ND	U	500	130	J+	5	ND	U	500	280	J	500
	N-BUTYLBENZENE	ND	U	100	14	J+	1	ND	U	100	ND	U	100
	N-PROPYLBENZENE	93	J	100	78	J+	1	84	J	100	97	J	100
	O-XYLENE	NA	--	--	NA	--	--	NA	--	--	NA	--	--
	P-ISOPROPYLTOLUENE	ND	U	100	38	J+	1	ND	U	100	57	J	100
	SEC-BUTYLBENZENE	ND	U	100	13	J+	1	ND	U	100	ND	U	100
	TERT-BUTYLBENZENE	ND	U	100	1	J+	1	ND	U	100	ND	U	100
	TETRACHLOROETHENE	NA	--	--	NA	--	--	NA	--	--	NA	--	--
	TOLUENE	9700		100	9400		100	8600		100	8200		100
	TRANS-1,2-DICHLOROETHENE	NA	--	--	NA	--	--	NA	--	--	NA	--	--
	TRICHLOROETHENE	ND	U	100	ND	U	1	ND	U	100	ND	U	100
	TRICHLOROFLUOROMETHANE	ND	U	100	ND	U	1	ND	U	100	ND	U	100
	VINYL CHLORIDE	NA	--	--	NA	--	--	NA	--	--	NA	--	--
	XYLENES	3300		50	3300		50	3000		50	3000		50

Refer to notes at the end of the table.

Table 10
Analytical Data Table for KAFB-106EX2

Phase Designation		Phase 3 Passive			Phase 4 Passive									
Sample ID		106EX2-P3P-111918			106EX2-P4P-012119			106EX2-LTM-081220			106EX2-LTM-101520			
Sample Date		11/19/2018			1/21/2019			8/12/2020			10/15/2020			
Sample Purpose		REG			REG			REG			REG			
Chemical Class and Analytical Method ^a	Parameter	Result	Val Qual	LOQ	Result	Val Qual	LOQ	Result	Val Qual	LOQ	Result	Val Qual	LOQ	
Microbial Community (cells/mL) QuantArray-Chlor	1,1 DCA Reductase (DCA)	ND	U	4.9	ND	U	5.1	ND	U	5.4	5.2		5.2	
	1,2 DCA Reductase (DCAR)	ND	U	4.9	ND	U	5.1	ND	U	5.4	5.2		5.2	
	BAV1 Vinyl Chloride Reductase (BVC)	ND	U	0.5	ND	U	0.5	ND	U	0.5	0.5		0.5	
	cer A Reductase	117		4.9	ND	U	5.1	ND	U	5.4	5.2		5.2	
	Chloroform Reductase (CFR)	ND	U	4.9	ND	U	5.1	ND	U	5.4	5.2		5.2	
	Dehalobacter DCM (DCM)	ND	U	4.9	ND	U	5.1	2360		5.4	7860		5.2	
	Dehalobacter spp. (DHBt)	84700		4.9	256000		5.1	44200		5.4	51700		5.2	
	Dehalobium chlorohercia (DECO)	3390		4.9	11000		5.1	1690		5.4	6130		5.2	
	Dehalococcoides (DHC)	ND	U	0.5	0.8		0.5	0.3	J	0.5	0.6		0.5	
	Dehalogenimonas spp. (DHG)	ND	U	4.9	ND	U	5.1	ND	U	5.4	5.2		5.2	
	Desulfotobacterium spp. (DSB)	40800		4.9	135000		5.1	35000		5.4	18400		5.2	
	Desulfuromonas spp. (DSM)	ND	U	4.9	ND	U	5.1	ND	U	5.4	5.3		5.2	
	Dichloromethane Dehalogenase (DCMA)	ND	U	4.9	ND	U	5.1	ND	U	5.4	5.2		5.2	
	Epoxyalkane Transferase (EtnE)	ND	U	4.9	111		5.1	ND	U	5.4	5.2		5.2	
	Ethene Monooxygenase (EtnC)	ND	U	4.9	ND	U	5.1	ND	U	5.4	5.2		5.2	
	Methanogens (MGN)	1390		4.9	4980		5.1	10000		5.4	22600		5.2	
	PCE Reductase (PCE-1)	ND	U	4.9	ND	U	5.1	ND	U	5.4	5.2		5.2	
	Phenol Hydroxylase (PHE)	3150		4.9	12400		5.1	8900		5.4	11200		5.2	
	PMMO	NA	--	--	NA	--	--	NA	--	--	NA	--	--	--
	Soluble Methane Monooxygenase (SMMO)	ND	U	4.9	ND	U	5.1	ND	U	5.4	5.2		5.2	
	Sulfate Reducing Bacteria (APS)	163000		4.9	357000		5.1	40700		5.4	36200		5.2	
	tceA Reductase (TCE)	ND	U	0.5	ND	U	0.5	ND	U	0.5	0.5		0.5	
	Toluene Dioxygenase (TOD)	ND	U	4.9	ND	U	5.1	ND	U	5.4	499		5.2	
Toluene Monooxygenase (RMO)	5160		4.9	14900		5.1	12300		5.4	27600		5.2		
Toluene Monooxygenase 2 (RDEG)	5880		4.9	6660		5.1	5140		5.4	7870		5.2		
Total Eubacteria (EBAC)	5520000		4.9	11100000		5.1	11900000		5.4	12100000		5.2		
trans-1,2-DCE Reductase (TDR)	ND	U	4.9	ND	U	5.1	ND	U	5.4	5.2		5.2		
Trichlorobenzene Dioxygenase (TCBO)	ND	U	4.9	ND	U	5.1	142		5.4	838		5.2		
Vinyl Chloride Reductase (VCR)	ND	U	0.5	ND	U	0.5	ND	U	0.5	0.5		0.5		
EDB (µg/L) EPA Method 8011	1,2-DIBROMOETHANE	55		0.29	62		0.3	2.7		0.1	0.36		0.011	
VFAs (mg/L) EPA Method 300m	ACETIC ACID	ND	U	1	9.1		1			11.1		10		
	BUTYRIC ACID	ND	U	1	ND	U	1			ND	U	10		
	FORMIC ACID	ND	U	1	ND	U	1			2.2	J	10		
	LACTIC ACID	ND	U	1	0.5	J	1			0.6	J	10		
	PROPIONIC ACID	ND	U	1	ND	U	1			ND	U	10		
	PYRUVIC ACID	ND	U	1	ND	U	1			ND	U	10		
	VALERIC ACID	ND	U	1	ND	U	1			ND	U	10		
Fluorometric (µg/L) Spectrofluorophotometry	FLUORESCEIN	NS	--	--	NS	--	--	NS	--	--	NS	--	--	
Reduced Gases (µg/L) RSKSOP-175	ACETYLENE	ND	U	10	ND	U	10	ND	U	10	ND	U	10	
	ETHANE	7.8		4	7.2		4	10.5		4	4.7		4	
	ETHYLENE	12.6		5	10.4		5	36.3		5	20.2		5	
	METHANE	168.3		2	128.3		2	1607.8		2	968.3		2	
	PROPANE	9.7		6	9.6		6	13.7		6	5.9	J	6	
General Chemistry (mg/L) SM2320b, EPA Method 300, EPA Method 353.2, SM4500 Pe ^c	ALKALINITY	360		5	360		5	474		5	465		5	
	BROMIDE	1.8		0.5	2		1	3.2		0.1	3.34		0.1	
	CHLORIDE	120		5	140		1	186		5	178		5	
	IODIDE	0.45	J	0.75	ND	U	0.75	ND	U	2	0.35			
	NITRATE	NS	--	--	NS	--	--	ND	U	0.1	ND	U	0.1	
	NITRITE	NS	--	--	NS	--	--	NS	--	--	NS	--	--	
	NITROGEN, NITRATE-NITRITE	ND	U	0.05	ND	UJ	0.05	ND	U	0.1	ND	U	0.1	
	O-PHOSPHATE (AS P)	NS	--	--	NS	--	--	NS	--	--	NS	--	--	
	ORTHOPHOSPHATE	ND	UJ	0.75	ND	UJ	0.15	NS	--	--	NS	--	--	
	PHOSPHORUS	NS	--	--	NS	--	--	ND	U	0.025	ND	U	0.025	
	SULFATE	26		1	22		2	0.246	J	0.5	ND	U	0.5	
Metals (mg/L) EPA Method 6010	LEAD	NS	--	--	NS	--	--	ND	U	0.001	ND	U	0.001	

Table 10
Analytical Data Table for KAFB-106EX2

Phase Designation		Phase 3 Passive			Phase 4 Passive			Phase 4 Passive			Phase 4 Passive		
Sample ID		106EX2-P3P-111918			106EX2-P4P-012119			106EX2-LTM-081220			106EX2-LTM-101520		
Sample Date		11/19/2018			1/21/2019			8/12/2020			10/15/2020		
Sample Purpose		REG			REG			REG			REG		
Chemical Class and Analytical Method ^a	Parameter	Result	Val Qual	LOQ	Result	Val Qual	LOQ	Result	Val Qual	LOQ	Result	Val Qual	LOQ
Dissolved Metals (mg/L) EPA Method 6010	IRON	4.2		0.05	4		0.05	7.89		0.05	5.17		0.05
	MANGANESE	5.9		0.003	5.2		0.003	7.18		0.125	5.33		0.125
δ2H (‰) Mass Spectrometry, USGS Reston, VA	DELTA2H	NS	--	--	NS	--	--	NS	--	--	NS	--	--
CSIA EDB δ13C (‰) Kuder et al, 2012	EDB δ	NS	--	--	NS	--	--	NS	--	--	NS	--	--
VOCs (µg/L) EPA Method 8260	1,1,2-TRICHLOROETHANE	ND	U	13	ND	U	10	ND	U	10	ND	U	5
	1,2,4-TRICHLOROBENZENE	NS	--	--	NS	--	--	ND	U	10	ND	U	10
	1,2,4-TRIMETHYLBENZENE	250		25	250		20	NA	--	--	NA	--	--
	1,2-DIBROMOETHANE	47		25	31		20	ND	U	5	ND	U	5
	1,2-DICHLOROETHANE	ND	U	25	NA	--	--	ND	U	5	ND	U	5
	1,3,5-TRIMETHYLBENZENE	83		13	84		10	160		10	150		5
	2-BUTANONE	ND	U	250	ND	U	200	ND	U	10	ND	U	10
	2-CHLOROTOLUENE	ND	U	13	ND	U	10	ND	U	10	ND	U	10
	2-HEXANONE	170	J	130	120	J	100	ND	U	20	ND	U	20
	4-METHYL-2-PENTANONE	110	J	130	73	J	100	ND	U	20	ND	U	20
	ACETONE	190	J	250	190	J	200	ND	U	10	ND	U	10
	BENZENE	3300		25	2300		20	2900		50	6700		50
	CARBON DISULFIDE	ND	U	50	ND	U	40	ND	U	10	ND	U	20
	CHLOROMETHANE	ND	U	25	ND	U	20	ND	U	5	ND	U	5
	CIS-1,2-DICHLOROETHENE	NA	--	--	NA	--	--	ND	U	5	ND	U	5
	DICHLORODIFLUOROMETHANE	ND	U	25	NA	--	--	ND	U	10	ND	U	5
	ETHYLBENZENE	800		25	NA	--	--	1200		10	1100		10
	ISOPROPYLBENZENE	99		25	93		20	110		10	96		5
	M,P-XYLENES	NA	--	--	NA	--	--	3100		10	3600		10
	METHYL TERT-BUTYL ETHER	ND	U	13	ND	U	10	ND	U	5	ND	U	5
	METHYLENE CHLORIDE	ND	U	130	ND	U	100	ND	U	10	ND	U	10
	NAPHTHALENE	120	J	130	110		100	150		10	160		5
	N-BUTYLBENZENE	ND	U	25	12	J	20	21		10	ND	U	10
	N-PROPYLBENZENE	72		25	70		20	140		10	64		10
	O-XYLENE	NA	--	--	NA	--	--	1300		10	1500		10
	P-ISOPROPYLTOLUENE	44		25	38		20	ND	U	10	ND	U	10
	SEC-BUTYLBENZENE	14	J	25	13	J	20	24		10	17		5
	TERT-BUTYLBENZENE	ND	U	25	ND	U	20	ND	U	10	ND	U	5
	TETRACHLOROETHENE	NA	--	--	NA	--	--	ND	U	10	ND	U	10
	TOLUENE	7000		50	4800		50	5900		50	6200		50
	TRANS-1,2-DICHLOROETHENE	NA	--	--	NA	--	--	ND	U	5	ND	U	5
	TRICHLOROETHENE	ND	U	25	ND	U	20	ND	U	5	ND	U	5
	TRICHLOROFLUOROMETHANE	ND	U	25	ND	U	20	ND	U	10	ND	U	10
	VINYL CHLORIDE	NA	--	--	NA	--	--	ND	U	5	ND	U	5
	XYLENES	2600		13	2200		10	4400		10	5200		10

Refer to notes at the end of the table.

Table 10
Analytical Data Table for KAFB-106EX2

Notes:

Sampling frequency for each analytical method is outlined in Table 4.

a. EPA analytical methods listed are for the most recent sampling event.

b. Samples were collected using Geotech Bladder Pumps.

c. Samples were recollected (except for QuantArray-Chlor analysis) using replacement QED Bladder Pumps.

-- = Not applicable.

δ2H - Delta Deuterium.

0/00 - Per mil.

cells/mL = Cells per milliliter.

EPA = Environmental Protection Agency.

FD = Field duplicate.

ID = Identification.

J = Estimated value, concentration is less than LOQ but greater than laboratory method detection limit (DL).

J+ = Estimated value, concentration is less than LOQ but greater than laboratory method detection limit (DL); biased high.

J- = Estimated value, concentration is less than LOQ but greater than laboratory method detection limit (DL); biased low.

KAFB = Kirtland Air Force Base.

LOQ = Limit of Quantitation

µg/L = Microgram per liter.

mg/L = Milligram per liter.

NA = Not analyzed.

ND = Not detected.

NS = Not sampled.

REG = Regular/parent sample.

U = Analyte was not detected. The reported numerical value is at or below the LOQ.

UJ = Analyte was not detected. The reported value is estimated.

VAL QUAL = Validation qualifier.

VFA - Volatile fatty acid.

VOC = Volatile organic compound.

Table 11
Analytical Data Table for KAFB-106IN1

Phase Designation		Original Baseline ^b			New Baseline - QED Pumps ^c			Phase 1 Recirculation					
Sample ID		106IN1-BL-062917			106IN1-BL-092617			106IN1-P1R-100217-1			106IN1-P1R-100217-2		
Sample Date		6/29/2017			9/26/2017			10/2/2017			10/2/2017		
Sample Purpose		REG			REG			REG			REG		
Chemical Class and Analytical Method ^a	Parameter	Result	Val Qual	LOQ	Result	Val Qual	LOQ	Result	Val Qual	LOQ	Result	Val Qual	LOQ
Microbial Community (cells/mL) QuantArray-Chlor	1,1 DCA Reductase (DCA)	ND	U	4.9	NS	--	--	NS	--	--	NS	--	--
	1,2 DCA Reductase (DCAR)	ND	U	4.9	NS	--	--	NS	--	--	NS	--	--
	BAV1 Vinyl Chloride Reductase (BVC)	ND	U	0.5	NS	--	--	NS	--	--	NS	--	--
	cer A Reductase	NA	--	--	NS	--	--	NS	--	--	NS	--	--
	Chloroform Reductase (CFR)	ND	U	4.9	NS	--	--	NS	--	--	NS	--	--
	Dehalobacter DCM (DCM)	ND	U	4.9	NS	--	--	NS	--	--	NS	--	--
	Dehalobacter spp. (DHBt)	155000		4.9	NS	--	--	NS	--	--	NS	--	--
	Dehalobium chloroocercia (DECO)	25700		4.9	NS	--	--	NS	--	--	NS	--	--
	Dehalococcoides (DHC)	ND	U	0.5	NS	--	--	NS	--	--	NS	--	--
	Dehalogenimonas spp. (DHG)	ND	U	4.9	NS	--	--	NS	--	--	NS	--	--
	Desulfotobacterium spp. (DSB)	1370000		4.9	NS	--	--	NS	--	--	NS	--	--
	Desulfuromonas spp. (DSM)	2	J	4.9	NS	--	--	NS	--	--	NS	--	--
	Dichloromethane Dehalogenase (DCMA)	ND	U	4.9	NS	--	--	NS	--	--	NS	--	--
	Epoxyalkane Transferase (EtnE)	1530		4.9	NS	--	--	NS	--	--	NS	--	--
	Ethene Monooxygenase (EtnC)	ND	U	4.9	NS	--	--	NS	--	--	NS	--	--
	Methanogens (MGN)	801		4.9	NS	--	--	NS	--	--	NS	--	--
	PCE Reductase (PCE-1)	NA	--	--	NS	--	--	NS	--	--	NS	--	--
	Phenol Hydroxylase (PHE)	204000		4.9	NS	--	--	NS	--	--	NS	--	--
	PMMO	2830		4.9	NS	--	--	NS	--	--	NS	--	--
	Soluble Methane Monooxygenase (SMMO)	10000		4.9	NS	--	--	NS	--	--	NS	--	--
	Sulfate Reducing Bacteria (APS)	193000		4.9	NS	--	--	NS	--	--	NS	--	--
	tceA Reductase (TCE)	ND	U	0.5	NS	--	--	NS	--	--	NS	--	--
	Toluene Dioxygenase (TOD)	1370		4.9	NS	--	--	NS	--	--	NS	--	--
	Toluene Monooxygenase (RMO)	393000		4.9	NS	--	--	NS	--	--	NS	--	--
	Toluene Monooxygenase 2 (RDEG)	304000		4.9	NS	--	--	NS	--	--	NS	--	--
Total Eubacteria (EBAC)	2530000		4.9	NS	--	--	NS	--	--	NS	--	--	
trans-1,2-DCE Reductase (TDR)	NA	--	--	NS	--	--	NS	--	--	NS	--	--	
Trichlorobenzene Dioxygenase (TCBO)	484		4.9	NS	--	--	NS	--	--	NS	--	--	
Vinyl Chloride Reductase (VCR)	ND	U	0.5	NS	--	--	NS	--	--	NS	--	--	
EDB (µg/L) EPA Method 8011	1,2-DIBROMOETHANE	47.4		1.88	20.1	J+	1.92	NS	--	--	NS	--	--
VFAs (mg/L) EPA Method 300m	ACETIC ACID	ND	U	1	1.17		1	NS	--	--	NS	--	--
	BUTYRIC ACID	ND	U	1	ND	U	1	NS	--	--	NS	--	--
	FORMIC ACID	ND	U	1	ND	U	1	NS	--	--	NS	--	--
	LACTIC ACID	ND	U	1	ND	U	1	NS	--	--	NS	--	--
	PROPIONIC ACID	ND	U	1	ND	U	1	NS	--	--	NS	--	--
	PYRUVIC ACID	ND	U	1	ND	U	1	NS	--	--	NS	--	--
	VALERIC ACID	ND	U	1	ND	U	1	NS	--	--	NS	--	--
Fluorometric (µg/L) Spectrofluorophotometry	FLUORESCEIN	ND	U	0.01	ND	U	0.01	566.7		0.01	540.1		0.01
Reduced Gases (µg/L) RSKSOP-175	ACETYLENE	ND	U	10	ND	U	10	NS	--	--	NS	--	--
	ETHANE	1.27	J	4	0.94	J	4	NS	--	--	NS	--	--
	ETHYLENE	2.3	J	5	4.36	J	5	NS	--	--	NS	--	--
	METHANE	2.15		2	1.49	J	2	NS	--	--	NS	--	--
	PROPANE	2.01	J	6	1.52	J	6	NS	--	--	NS	--	--
General Chemistry (mg/L) SM2320b, EPA Method 300, EPA Method 353.2, SM4500 Pec	ALKALINITY	261		1	299		1	NS	--	--	NS	--	--
	BROMIDE	0.621	J-	0.125	0.515		0.25	NS	--	--	NS	--	--
	CHLORIDE	48.6		0.66	45.3		0.66	NS	--	--	NS	--	--
	IODIDE	ND	U	0.2	ND	U	0.75	NS	--	--	NS	--	--
	NITRATE	NS	--	--	NS	--	--	NS	--	--	NS	--	--
	NITRITE	NS	--	--	NS	--	--	NS	--	--	NS	--	--
	NITROGEN, NITRATE-NITRITE	ND	U	0.375	ND	U	0.375	NS	--	--	NS	--	--
	O-PHOSPHATE (AS P)	0.0425		0.02	0.209	J+	0.02	NS	--	--	NS	--	--
	ORTHOPHOSPHATE	NS	--	--	NS	--	--	NS	--	--	NS	--	--
	PHOSPHORUS	NS	--	--	NS	--	--	NS	--	--	NS	--	--
	SULFATE	3.03	J	2	ND	U	2	NS	--	--	NS	--	--

Table 11
Analytical Data Table for KAFB-106IN1

Phase Designation		Original Baseline ^b			New Baseline - QED Pumps ^c			Phase 1 Recirculation					
Sample ID		106IN1-BL-062917			106IN1-BL-092617			106IN1-P1R-100217-1			106IN1-P1R-100217-2		
Sample Date		6/29/2017			9/26/2017			10/2/2017			10/2/2017		
Sample Purpose		REG			REG			REG			REG		
Chemical Class and Analytical Method ^a	Parameter	Result	Val Qual	LOQ	Result	Val Qual	LOQ	Result	Val Qual	LOQ	Result	Val Qual	LOQ
Metals (mg/L) EPA Method 6010	LEAD	NS	--	--	NS	--	--	NS	--	--	NS	--	--
Dissolved Metals (mg/L) EPA Method 6010	IRON	4.81		0.06	13.8		0.06	NS	--	--	NS	--	--
	MANGANESE	3.27		0.006	3.31		0.006	NS	--	--	NS	--	--
δ2H (‰) Mass Spectrometry, USGS Reston, VA	DELTA2H	-92.97		-99	-93.85		-99	576.52		-99	608.76		-99
CSIA EDB δ13C (‰) Kuder et al, 2012	EDB δ	NA	--	--	-5.0 ±2‰	--	--	NS	--	--	NS	--	--
VOCs (µg/L) EPA Method 8260	1,1,2-TRICHLOROETHANE	ND	U	10	ND	U	12.5	NS	--	--	NS	--	--
	1,2,4-TRICHLOROBENZENE	NA	--	--	NA	--	--	NS	--	--	NS	--	--
	1,2,4-TRIMETHYLBENZENE	183		10	193		12.5	NS	--	--	NS	--	--
	1,2-DIBROMOETHANE	75		10	28.6		12.5	NS	--	--	NS	--	--
	1,2-DICHLOROETHANE	ND	U	10	6.76	J	12.5	NS	--	--	NS	--	--
	1,3,5-TRIMETHYLBENZENE	63.6		10	62.8		12.5	NS	--	--	NS	--	--
	2-BUTANONE	1570		100	163	J	125	NS	--	--	NS	--	--
	2-CHLOROTOLUENE	ND	U	10	ND	U	12.5	NS	--	--	NS	--	--
	2-HEXANONE	220		50	136		62.5	NS	--	--	NS	--	--
	4-METHYL-2-PENTANONE	82.4	J	50	98.3	J	62.5	NS	--	--	NS	--	--
	ACETONE	1780		100	667		125	NS	--	--	NS	--	--
	BENZENE	1930		10	1930		12.5	NS	--	--	NS	--	--
	CARBON DISULFIDE	ND	U	10	7.23	J	12.5	NS	--	--	NS	--	--
	CHLOROMETHANE	ND	U	10	ND	U	12.5	NS	--	--	NS	--	--
	CIS-1,2-DICHLOROETHENE	NA	--	--	NA	--	--	NS	--	--	NS	--	--
	DICHLORODIFLUOROMETHANE	ND	U	20	ND	U	25	NS	--	--	NS	--	--
	ETHYLBENZENE	396		10	696		12.5	NS	--	--	NS	--	--
	ISOPROPYLBENZENE	31.3		10	49.5		12.5	NS	--	--	NS	--	--
	M,P-XYLENES	NA	--	--	NA	--	--	NS	--	--	NS	--	--
	METHYL TERT-BUTYL ETHER	ND	U	10	ND	U	12.5	NS	--	--	NS	--	--
	METHYLENE CHLORIDE	ND	U	20	ND	U	25	NS	--	--	NS	--	--
	NAPHTHALENE	46		10	80		12.5	NS	--	--	NS	--	--
	N-BUTYLBENZENE	8.21	J	10	8.26	J	12.5	NS	--	--	NS	--	--
	N-PROPYLBENZENE	29.3		10	45.5		12.5	NS	--	--	NS	--	--
	O-XYLENE	NA	--	--	NA	--	--	NS	--	--	NS	--	--
	P-ISOPROPYLTOLUENE	6.71	J	10	7.24	J	12.5	NS	--	--	NS	--	--
	SEC-BUTYLBENZENE	ND	U	10	8.72	J	12.5	NS	--	--	NS	--	--
	TERT-BUTYLBENZENE	ND	U	10	ND	U	12.5	NS	--	--	NS	--	--
	TETRACHLOROETHENE	NA	--	--	NA	--	--	NS	--	--	NS	--	--
	TOLUENE	3680		10	2730		12.5	NS	--	--	NS	--	--
	TRANS-1,2-DICHLOROETHENE	NA	--	--	NA	--	--	NS	--	--	NS	--	--
	TRICHLOROETHENE	ND	U	10	ND	U	12.5	NS	--	--	NS	--	--
	TRICHLOROFUOROMETHANE	ND	U	20	ND	U	25	NS	--	--	NS	--	--
	VINYL CHLORIDE	NA	--	--	NA	--	--	NS	--	--	NS	--	--
	XYLENES	1720		30	1640		37.5	NS	--	--	NS	--	--

Refer to notes at the end of the table.

Table 11
Analytical Data Table for KAFB-106IN1

Phase Designation		Phase 1 Recirculation			Phase 1 Passive								
Sample ID		106IN1-P1R-100317-3			106IN1-P1P-111617			106IN1-P1P-111617-FD			106IN1-P1P-112917		
Sample Date		10/3/2017			11/16/2017			11/16/2017			11/29/2017		
Sample Purpose		REG			REG			FD			REG		
Chemical Class and Analytical Method ^a	Parameter	Result	Val Qual	LOQ	Result	Val Qual	LOQ	Result	Val Qual	LOQ	Result	Val Qual	LOQ
Microbial Community (cells/mL) QuantArray-Chlor	1,1 DCA Reductase (DCA)	NS	--	--	NS	--	--	NS	--	--	ND	U	7.1
	1,2 DCA Reductase (DCAR)	NS	--	--	NS	--	--	NS	--	--	ND	U	7.1
	BAV1 Vinyl Chloride Reductase (BVC)	NS	--	--	NS	--	--	NS	--	--	ND	U	0.7
	cer A Reductase	NS	--	--	NS	--	--	NS	--	--	NA	--	--
	Chloroform Reductase (CFR)	NS	--	--	NS	--	--	NS	--	--	ND	U	7.1
	Dehalobacter DCM (DCM)	NS	--	--	NS	--	--	NS	--	--	ND	U	7.1
	Dehalobacter spp. (DHBt)	NS	--	--	NS	--	--	NS	--	--	45900		7.1
	Dehalobium chloroocercia (DECO)	NS	--	--	NS	--	--	NS	--	--	7550		7.1
	Dehalococcoides (DHC)	NS	--	--	NS	--	--	NS	--	--	0.9		0.7
	Dehalogenimonas spp. (DHG)	NS	--	--	NS	--	--	NS	--	--	ND	U	7.1
	Desulfotobacterium spp. (DSB)	NS	--	--	NS	--	--	NS	--	--	84000		7.1
	Desulfuromonas spp. (DSM)	NS	--	--	NS	--	--	NS	--	--	ND	U	7.1
	Dichloromethane Dehalogenase (DCMA)	NS	--	--	NS	--	--	NS	--	--	ND	U	7.1
	Epoxyalkane Transferase (EtnE)	NS	--	--	NS	--	--	NS	--	--	ND	U	7.1
	Ethene Monooxygenase (EtnC)	NS	--	--	NS	--	--	NS	--	--	ND	U	7.1
	Methanogens (MGN)	NS	--	--	NS	--	--	NS	--	--	254		7.1
	PCE Reductase (PCE-1)	NS	--	--	NS	--	--	NS	--	--	NA	--	--
	Phenol Hydroxylase (PHE)	NS	--	--	NS	--	--	NS	--	--	6530		7.1
	PMMO	NS	--	--	NS	--	--	NS	--	--	0.3	J	7.1
	Soluble Methane Monooxygenase (SMMO)	NS	--	--	NS	--	--	NS	--	--	ND	U	7.1
	Sulfate Reducing Bacteria (APS)	NS	--	--	NS	--	--	NS	--	--	65400		7.1
	tceA Reductase (TCE)	NS	--	--	NS	--	--	NS	--	--	1.4		0.7
	Toluene Dioxygenase (TOD)	NS	--	--	NS	--	--	NS	--	--	3500		7.1
	Toluene Monooxygenase (RMO)	NS	--	--	NS	--	--	NS	--	--	57400		7.1
	Toluene Monooxygenase 2 (RDEG)	NS	--	--	NS	--	--	NS	--	--	31700		7.1
Total Eubacteria (EBAC)	NS	--	--	NS	--	--	NS	--	--	9460000		7.1	
trans-1,2-DCE Reductase (TDR)	NS	--	--	NS	--	--	NS	--	--	NA	--	--	
Trichlorobenzene Dioxygenase (TCBO)	NS	--	--	NS	--	--	NS	--	--	ND	U	7.1	
Vinyl Chloride Reductase (VCR)	NS	--	--	NS	--	--	NS	--	--	2.3		0.7	
EDB (µg/L) EPA Method 8011	1,2-DIBROMOETHANE	NS	--	--	19.9		3.8	22.1		3.88	23.8		1.94
VFAs (mg/L) EPA Method 300m	ACETIC ACID	NS	--	--	108		1	114		1	102		1
	BUTYRIC ACID	NS	--	--	9.2		1	10.1		1	4.78		1
	FORMIC ACID	NS	--	--	ND	U	1	ND	U	1	ND	U	1
	LACTIC ACID	NS	--	--	ND	U	1	ND	U	1	ND	U	1
	PROPIONIC ACID	NS	--	--	21.9		1	22.7		1	19.3		1
	PYRUVIC ACID	NS	--	--	ND	U	1	ND	U	1	ND	U	1
Fluorometric (µg/L) Spectrofluorophotometry	VALERIC ACID	NS	--	--	4.34		1	4.03		1	3.88		1
	FLUORESCEIN	592.2		0.01	3.338		0.01	NS	--	--	3.197		0.01
Reduced Gases (µg/L) RSKSOP-175	ACETYLENE	NS	--	--	ND	U	10	ND	U	10	ND	U	10
	ETHANE	NS	--	--	ND	U	4	ND	U	4	1.54	J	4
	ETHYLENE	NS	--	--	4.04	J	5	4.03	J	5	6.02		5
	METHANE	NS	--	--	18		2	17.3		2	354		2
	PROPANE	NS	--	--	ND	U	6	ND	U	6	ND	U	6
General Chemistry (mg/L) SM2320b, EPA Method 300, EPA Method 353.2, SM4500 Pec	ALKALINITY	NS	--	--	314		1	289		1	298		1
	BROMIDE	NS	--	--	0.676		0.25	0.683		0.25	0.78		0.25
	CHLORIDE	NS	--	--	48.8		0.66	49		0.66	55.6		0.66
	IODIDE	NS	--	--	ND	U	0.75	ND	U	0.75	ND	U	0.75
	NITRATE	NS	--	--	NS	--	--	NS	--	--	NS	--	--
	NITRITE	NS	--	--	NS	--	--	NS	--	--	NS	--	--
	NITROGEN, NITRATE-NITRITE	NS	--	--	ND	U	0.375	ND	U	0.375	ND	U	0.375
	O-PHOSPHATE (AS P)	NS	--	--	0.0245	J	0.02	0.0171	J	0.02	0.109		0.02
	ORTHOPHOSPHATE	NS	--	--	NS	--	--	NS	--	--	NS	--	--
	PHOSPHORUS	NS	--	--	NS	--	--	NS	--	--	NS	--	--
	SULFATE	NS	--	--	ND	U	2	ND	U	2	ND	U	2

Table 11
Analytical Data Table for KAFB-106IN1

Phase Designation		Phase 1 Recirculation			Phase 1 Passive								
Sample ID		106IN1-P1R-100317-3			106IN1-P1P-111617			106IN1-P1P-111617-FD			106IN1-P1P-112917		
Sample Date		10/3/2017			11/16/2017			11/16/2017			11/29/2017		
Sample Purpose		REG			REG			FD			REG		
Chemical Class and Analytical Method ^a	Parameter	Result	Val Qual	LOQ	Result	Val Qual	LOQ	Result	Val Qual	LOQ	Result	Val Qual	LOQ
Metals (mg/L) EPA Method 6010	LEAD	NS	--	--	NS	--	--	NS	--	--	NS	--	--
Dissolved Metals (mg/L) EPA Method 6010	IRON	NS	--	--	25.5		0.06	24.8		0.06	23.2		0.06
	MANGANESE	NS	--	--	3.09		0.006	3.06		0.006	3.08		0.006
δ2H (‰) Mass Spectrometry, USGS Reston, VA	DELTA2H	588.99		-99	-88.51		-99	-87.39		-99	-87.49		-99
CSIA EDB δ13C (‰) Kuder et al, 2012	EDB δ	NS	--	--	NS	--	--	NS	--	--	-7.7±2‰	--	--
VOCs (µg/L) EPA Method 8260	1,1,2-TRICHLOROETHANE	NS	--	--	ND	U	50	ND	U	50	ND	U	25
	1,2,4-TRICHLOROBENZENE	NS	--	--	NS	--	--	NS	--	--	NS	--	--
	1,2,4-TRIMETHYLBENZENE	NS	--	--	194		50	170		50	172		25
	1,2-DIBROMOETHANE	NS	--	--	26.5	J	50	26.4	J	50	29.6	J	25
	1,2-DICHLOROETHANE	NS	--	--	ND	U	50	ND	U	50	ND	U	25
	1,3,5-TRIMETHYLBENZENE	NS	--	--	68.7	J	50	58.3	J	50	63.6		25
	2-BUTANONE	NS	--	--	ND	U	500	ND	U	500	127	J	250
	2-CHLOROTOLUENE	NS	--	--	ND	U	50	ND	U	50	ND	U	25
	2-HEXANONE	NS	--	--	ND	U	250	ND	U	250	139	J	125
	4-METHYL-2-PENTANONE	NS	--	--	ND	U	250	ND	U	250	102	J	125
	ACETONE	NS	--	--	466	J-	500	451	J-	500	469	J	250
	BENZENE	NS	--	--	2950		50	2590		50	2970		25
	CARBON DISULFIDE	NS	--	--	ND	U	50	ND	U	50	ND	U	25
	CHLOROMETHANE	NS	--	--	ND	U	50	ND	U	50	ND	U	25
	CIS-1,2-DICHLOROETHENE	NS	--	--	NA	--	--	NA	--	--	NA	--	--
	DICHLORODIFLUOROMETHANE	NS	--	--	ND	U	100	ND	U	100	ND	U	50
	ETHYLBENZENE	NS	--	--	576		50	483		50	601		25
	ISOPROPYLBENZENE	NS	--	--	57.5	J	50	49.6	J	50	70.2		25
	M,P-XYLENES	NS	--	--	NA	--	--	NA	--	--	NA	--	--
	METHYL TERT-BUTYL ETHER	NS	--	--	ND	U	50	ND	U	50	ND	U	25
	METHYLENE CHLORIDE	NS	--	--	ND	U	100	ND	U	100	ND	U	50
	NAPHTHALENE	NS	--	--	73.6	J	50	77	J	50	81.9		25
	N-BUTYLBENZENE	NS	--	--	ND	U	50	ND	U	50	ND	U	25
	N-PROPYLBENZENE	NS	--	--	45.6	J	50	39.3	J	50	53.4		25
	O-XYLENE	NS	--	--	NA	--	--	NA	--	--	NA	--	--
	P-ISOPROPYLTOLUENE	NS	--	--	ND	U	50	ND	U	50	33.7	J	25
	SEC-BUTYLBENZENE	NS	--	--	ND	U	50	ND	U	50	ND	U	25
	TERT-BUTYLBENZENE	NS	--	--	ND	U	50	ND	U	50	ND	U	25
	TETRACHLOROETHENE	NS	--	--	NA	--	--	NA	--	--	NA	--	--
	TOLUENE	NS	--	--	6210		50	5140		50	5540		25
	TRANS-1,2-DICHLOROETHENE	NS	--	--	NA	--	--	NA	--	--	NA	--	--
	TRICHLOROETHENE	NS	--	--	ND	U	50	ND	U	50	ND	U	25
	TRICHLOROFUOROMETHANE	NS	--	--	ND	U	100	ND	U	100	ND	U	50
	VINYL CHLORIDE	NS	--	--	NA	--	--	NA	--	--	NA	--	--
	XYLENES	NS	--	--	1790		150	1520		150	1930		75

Refer to notes at the end of the table.

Table 11
Analytical Data Table for KAFB-106IN1

Phase Designation		Phase 2 Recirculation											
Sample ID		106IN1-P2R-010218-01			106IN1-P2R-010218-02			106IN1-P2R-011018-03			106IN1-P2R-012418		
Sample Date		1/2/2018			1/2/2018			1/10/2018			1/24/2018		
Sample Purpose		REG			REG			REG			REG		
Chemical Class and Analytical Method ^a	Parameter	Result	Val Qual	LOQ	Result	Val Qual	LOQ	Result	Val Qual	LOQ	Result	Val Qual	LOQ
Microbial Community (cells/mL) QuantArray-Chlor	1,1 DCA Reductase (DCA)	NS	--	--	NS	--	--	NS	--	--	NS	--	--
	1,2 DCA Reductase (DCAR)	NS	--	--	NS	--	--	NS	--	--	NS	--	--
	BAV1 Vinyl Chloride Reductase (BVC)	NS	--	--	NS	--	--	NS	--	--	NS	--	--
	cer A Reductase	NS	--	--	NS	--	--	NS	--	--	NS	--	--
	Chloroform Reductase (CFR)	NS	--	--	NS	--	--	NS	--	--	NS	--	--
	Dehalobacter DCM (DCM)	NS	--	--	NS	--	--	NS	--	--	NS	--	--
	Dehalobacter spp. (DHBt)	NS	--	--	NS	--	--	NS	--	--	NS	--	--
	Dehalobium chloroocercia (DECO)	NS	--	--	NS	--	--	NS	--	--	NS	--	--
	Dehalococcoides (DHC)	NS	--	--	NS	--	--	NS	--	--	NS	--	--
	Dehalogenimonas spp. (DHG)	NS	--	--	NS	--	--	NS	--	--	NS	--	--
	Desulfitobacterium spp. (DSB)	NS	--	--	NS	--	--	NS	--	--	NS	--	--
	Desulfuromonas spp. (DSM)	NS	--	--	NS	--	--	NS	--	--	NS	--	--
	Dichloromethane Dehalogenase (DCMA)	NS	--	--	NS	--	--	NS	--	--	NS	--	--
	Epoxyalkane Transferase (EtnE)	NS	--	--	NS	--	--	NS	--	--	NS	--	--
	Ethene Monooxygenase (EtnC)	NS	--	--	NS	--	--	NS	--	--	NS	--	--
	Methanogens (MGN)	NS	--	--	NS	--	--	NS	--	--	NS	--	--
	PCE Reductase (PCE-1)	NS	--	--	NS	--	--	NS	--	--	NS	--	--
	Phenol Hydroxylase (PHE)	NS	--	--	NS	--	--	NS	--	--	NS	--	--
	PMMO	NS	--	--	NS	--	--	NS	--	--	NS	--	--
	Soluble Methane Monooxygenase (SMMO)	NS	--	--	NS	--	--	NS	--	--	NS	--	--
	Sulfate Reducing Bacteria (APS)	NS	--	--	NS	--	--	NS	--	--	NS	--	--
	tceA Reductase (TCE)	NS	--	--	NS	--	--	NS	--	--	NS	--	--
	Toluene Dioxygenase (TOD)	NS	--	--	NS	--	--	NS	--	--	NS	--	--
	Toluene Monooxygenase (RMO)	NS	--	--	NS	--	--	NS	--	--	NS	--	--
Toluene Monooxygenase 2 (RDEG)	NS	--	--	NS	--	--	NS	--	--	NS	--	--	
Total Eubacteria (EBAC)	NS	--	--	NS	--	--	NS	--	--	NS	--	--	
trans-1,2-DCE Reductase (TDR)	NS	--	--	NS	--	--	NS	--	--	NS	--	--	
Trichlorobenzene Dioxygenase (TCBO)	NS	--	--	NS	--	--	NS	--	--	NS	--	--	
Vinyl Chloride Reductase (VCR)	NS	--	--	NS	--	--	NS	--	--	NS	--	--	
EDB (µg/L) EPA Method 8011	1,2-DIBROMOETHANE	NS	--	--	NS	--	--	NS	--	--	NS	--	--
VFAs (mg/L) EPA Method 300m	ACETIC ACID	NS	--	--	ND	U	1	ND	U	1	26.3		1
	BUTYRIC ACID	NS	--	--	ND	U	1	ND	U	1	ND	U	1
	FORMIC ACID	NS	--	--	ND	U	1	ND	U	1	ND	U	1
	LACTIC ACID	NS	--	--	140		20	144	J	10	154	J	1
	PROPIONIC ACID	NS	--	--	ND	U	1	ND	U	1	ND	U	1
	PYRUVIC ACID	NS	--	--	ND	U	1	ND	U	1	ND	U	1
Fluorometric (µg/L) Spectrofluorophotometry	VALERIC ACID	NS	--	--	ND	U	1	ND	U	1	ND	U	1
	FLUORESCEIN	NS	--	--	NS	--	--	NS	--	--	NS	--	--
Reduced Gases (µg/L) RSKSOP-175	ACETYLENE	NS	--	--	NS	--	--	NS	--	--	NS	--	--
	ETHANE	NS	--	--	NS	--	--	NS	--	--	NS	--	--
	ETHYLENE	NS	--	--	NS	--	--	NS	--	--	NS	--	--
	METHANE	NS	--	--	NS	--	--	NS	--	--	NS	--	--
	PROPANE	NS	--	--	NS	--	--	NS	--	--	NS	--	--
General Chemistry (mg/L) SM2320b, EPA Method 300, EPA Method 353.2, SM4500 Pec	ALKALINITY	NS	--	--	NS	--	--	NS	--	--	NS	--	--
	BROMIDE	NS	--	--	NS	--	--	NS	--	--	NS	--	--
	CHLORIDE	NS	--	--	NS	--	--	NS	--	--	NS	--	--
	IODIDE	18		0.75	18		0.75	18		0.75	26		1.5
	NITRATE	NS	--	--	NS	--	--	NS	--	--	NS	--	--
	NITRITE	NS	--	--	NS	--	--	NS	--	--	NS	--	--
	NITROGEN, NITRATE-NITRITE	NS	--	--	NS	--	--	NS	--	--	NS	--	--
	O-PHOSPHATE (AS P)	NS	--	--	NS	--	--	NS	--	--	9.74		1
	ORTHOPHOSPHATE	NS	--	--	NS	--	--	NS	--	--	NS	--	--
	PHOSPHORUS	NS	--	--	NS	--	--	NS	--	--	NS	--	--
	SULFATE	NS	--	--	NS	--	--	NS	--	--	NS	--	--

Table 11
Analytical Data Table for KAFB-106IN1

Phase Designation		Phase 2 Recirculation											
Sample ID		106IN1-P2R-010218-01			106IN1-P2R-010218-02			106IN1-P2R-011018-03			106IN1-P2R-012418		
Sample Date		1/2/2018			1/2/2018			1/10/2018			1/24/2018		
Sample Purpose		REG			REG			REG			REG		
Chemical Class and Analytical Method ^a	Parameter	Result	Val Qual	LOQ	Result	Val Qual	LOQ	Result	Val Qual	LOQ	Result	Val Qual	LOQ
Metals (mg/L) EPA Method 6010	LEAD	NS	--	--	NS	--	--	NS	--	--	NS	--	--
Dissolved Metals (mg/L) EPA Method 6010	IRON	NS	--	--	NS	--	--	NS	--	--	NS	--	--
	MANGANESE	NS	--	--	NS	--	--	NS	--	--	NS	--	--
δ2H (‰) Mass Spectrometry, USGS Reston, VA	DELTA2H	NS	--	--	NS	--	--	NS	--	--	NS	--	--
CSIA EDB δ13C (‰) Kuder et al, 2012	EDB δ	NS	--	--	NS	--	--	NS	--	--	NS	--	--
VOCs (µg/L) EPA Method 8260	1,1,2-TRICHLOROETHANE	NS	--	--	NS	--	--	NS	--	--	NS	--	--
	1,2,4-TRICHLOROBENZENE	NS	--	--	NS	--	--	NS	--	--	NS	--	--
	1,2,4-TRIMETHYLBENZENE	NS	--	--	NS	--	--	NS	--	--	NS	--	--
	1,2-DIBROMOETHANE	NS	--	--	NS	--	--	NS	--	--	NS	--	--
	1,2-DICHLOROETHANE	NS	--	--	NS	--	--	NS	--	--	NS	--	--
	1,3,5-TRIMETHYLBENZENE	NS	--	--	NS	--	--	NS	--	--	NS	--	--
	2-BUTANONE	NS	--	--	NS	--	--	NS	--	--	NS	--	--
	2-CHLOROTOLUENE	NS	--	--	NS	--	--	NS	--	--	NS	--	--
	2-HEXANONE	NS	--	--	NS	--	--	NS	--	--	NS	--	--
	4-METHYL-2-PENTANONE	NS	--	--	NS	--	--	NS	--	--	NS	--	--
	ACETONE	NS	--	--	NS	--	--	NS	--	--	NS	--	--
	BENZENE	NS	--	--	NS	--	--	NS	--	--	NS	--	--
	CARBON DISULFIDE	NS	--	--	NS	--	--	NS	--	--	NS	--	--
	CHLOROMETHANE	NS	--	--	NS	--	--	NS	--	--	NS	--	--
	CIS-1,2-DICHLOROETHENE	NS	--	--	NS	--	--	NS	--	--	NS	--	--
	DICHLORODIFLUOROMETHANE	NS	--	--	NS	--	--	NS	--	--	NS	--	--
	ETHYLBENZENE	NS	--	--	NS	--	--	NS	--	--	NS	--	--
	ISOPROPYLBENZENE	NS	--	--	NS	--	--	NS	--	--	NS	--	--
	M,P-XYLENES	NS	--	--	NS	--	--	NS	--	--	NS	--	--
	METHYL TERT-BUTYL ETHER	NS	--	--	NS	--	--	NS	--	--	NS	--	--
	METHYLENE CHLORIDE	NS	--	--	NS	--	--	NS	--	--	NS	--	--
	NAPHTHALENE	NS	--	--	NS	--	--	NS	--	--	NS	--	--
	N-BUTYLBENZENE	NS	--	--	NS	--	--	NS	--	--	NS	--	--
	N-PROPYLBENZENE	NS	--	--	NS	--	--	NS	--	--	NS	--	--
	O-XYLENE	NS	--	--	NS	--	--	NS	--	--	NS	--	--
	P-ISOPROPYLTOLUENE	NS	--	--	NS	--	--	NS	--	--	NS	--	--
	SEC-BUTYLBENZENE	NS	--	--	NS	--	--	NS	--	--	NS	--	--
	TERT-BUTYLBENZENE	NS	--	--	NS	--	--	NS	--	--	NS	--	--
	TETRACHLOROETHENE	NS	--	--	NS	--	--	NS	--	--	NS	--	--
	TOLUENE	NS	--	--	NS	--	--	NS	--	--	NS	--	--
	TRANS-1,2-DICHLOROETHENE	NS	--	--	NS	--	--	NS	--	--	NS	--	--
	TRICHLOROETHENE	NS	--	--	NS	--	--	NS	--	--	NS	--	--
	TRICHLOROFLUOROMETHANE	NS	--	--	NS	--	--	NS	--	--	NS	--	--
	VINYL CHLORIDE	NS	--	--	NS	--	--	NS	--	--	NS	--	--
	XYLENES	NS	--	--	NS	--	--	NS	--	--	NS	--	--

Refer to notes at the end of the table.

Table 11
Analytical Data Table for KAFB-106IN1

Phase Designation		Phase 2 Passive											
Sample ID		106IN1-P2P-030718			106IN1-P2P-041118			106IN1-P2P-050918			106IN1-P2P-061418		
Sample Date		3/7/2018			4/11/2018			5/9/2018			6/14/2018		
Sample Purpose		REG			REG			REG			REG		
Chemical Class and Analytical Method ^a	Parameter	Result	Val Qual	LOQ	Result	Val Qual	LOQ	Result	Val Qual	LOQ	Result	Val Qual	LOQ
Microbial Community (cells/mL) QuantArray-Chlor	1,1 DCA Reductase (DCA)	NS	--	--	NS	--	--	ND	U	62.5	NS	--	--
	1,2 DCA Reductase (DCAR)	NS	--	--	NS	--	--	ND	U	62.5	NS	--	--
	BAV1 Vinyl Chloride Reductase (BVC)	NS	--	--	NS	--	--	ND	U	6.3	NS	--	--
	cer A Reductase	NS	--	--	NS	--	--	ND	U	62.5	NS	--	--
	Chloroform Reductase (CFR)	NS	--	--	NS	--	--	ND	U	62.5	NS	--	--
	Dehalobacter DCM (DCM)	NS	--	--	NS	--	--	37500		62.5	NS	--	--
	Dehalobacter spp. (DHBt)	NS	--	--	NS	--	--	1380000		62.5	NS	--	--
	Dehalobium chloroocercia (DECO)	NS	--	--	NS	--	--	478000		62.5	NS	--	--
	Dehalococcoides (DHC)	NS	--	--	NS	--	--	ND	U	6.3	NS	--	--
	Dehalogenimonas spp. (DHG)	NS	--	--	NS	--	--	12800		62.5	NS	--	--
	Desulfitobacterium spp. (DSB)	NS	--	--	NS	--	--	392000		62.5	NS	--	--
	Desulfuromonas spp. (DSM)	NS	--	--	NS	--	--	ND	U	62.5	NS	--	--
	Dichloromethane Dehalogenase (DCMA)	NS	--	--	NS	--	--	ND	U	62.5	NS	--	--
	Epoxyalkane Transferase (EtnE)	NS	--	--	NS	--	--	ND	U	62.5	NS	--	--
	Ethene Monooxygenase (EtnC)	NS	--	--	NS	--	--	ND	U	62.5	NS	--	--
	Methanogens (MGN)	NS	--	--	NS	--	--	265000		62.5	NS	--	--
	PCE Reductase (PCE-1)	NS	--	--	NS	--	--	ND	U	62.5	NS	--	--
	Phenol Hydroxylase (PHE)	NS	--	--	NS	--	--	82700		62.5	NS	--	--
	PMMO	NS	--	--	NS	--	--	NA	--	--	NS	--	--
	Soluble Methane Monooxygenase (SMMO)	NS	--	--	NS	--	--	ND	U	62.5	NS	--	--
	Sulfate Reducing Bacteria (APS)	NS	--	--	NS	--	--	1750000		62.5	NS	--	--
	tceA Reductase (TCE)	NS	--	--	NS	--	--	ND	U	6.3	NS	--	--
	Toluene Dioxygenase (TOD)	NS	--	--	NS	--	--	ND	U	62.5	NS	--	--
	Toluene Monooxygenase (RMO)	NS	--	--	NS	--	--	78900		62.5	NS	--	--
	Toluene Monooxygenase 2 (RDEG)	NS	--	--	NS	--	--	58000		62.5	NS	--	--
Total Eubacteria (EBAC)	NS	--	--	NS	--	--	157000000		62.5	NS	--	--	
trans-1,2-DCE Reductase (TDR)	NS	--	--	NS	--	--	ND	U	62.5	NS	--	--	
Trichlorobenzene Dioxygenase (TCBO)	NS	--	--	NS	--	--	ND	U	62.5	NS	--	--	
Vinyl Chloride Reductase (VCR)	NS	--	--	NS	--	--	ND	U	6.3	NS	--	--	
EDB (µg/L) EPA Method 8011	1,2-DIBROMOETHANE	0.129		0.0193	ND	U	0.0194	ND	U	0.019	ND	U	0.0192
VFAs (mg/L) EPA Method 300m	ACETIC ACID	312		10	55.1		20	20.7		3	11.4	J	10
	BUTYRIC ACID	34.7		1	ND	U	1	ND	U	3	ND	UJ	10
	FORMIC ACID	14.7		1	ND	U	1	ND	U	3	ND	UJ	10
	LACTIC ACID	ND	U	1	ND	U	1	2.48	J	3	ND	UJ	10
	PROPIONIC ACID	170		10	121		20	89.3		10	8.7	J	10
	PYRUVIC ACID	47		1	11.2	J	20	ND	U	3	ND	UJ	10
	VALERIC ACID	9.1		1	2.9		1	ND	U	3	ND	UJ	10
Fluorometric (µg/L) Spectrofluorophotometry	FLUORESC EIN	NS	--	--	NS	--	--	NS	--	--	NS	--	--
Reduced Gases (µg/L) RSKSOP-175	ACETYLENE	ND	U	10	ND	U	10	ND	U	10	ND	UJ	10
	ETHANE	1.9	J	4	0.66	J	4	0.65	J	4	1	J	4
	ETHYLENE	5		5	2.5		5	1.73	J	5	2.5	J	5
	METHANE	8200		20	12400		20	10800		20	15300	J	20
	PROPANE	2.4	J	6	0.92	J	6	0.97	J	6	1.1	J	6
General Chemistry (mg/L) SM2320b, EPA Method 300, EPA Method 353.2, SM4500 Pec	ALKALINITY	578		1	668		1	787		1	762	J-	1
	BROMIDE	0.55	J	1.25	0.578	J	0.625	0.77		0.25	ND	U	1.25
	CHLORIDE	45.6		3.3	61.5		1.65	77.5		0.66	77.9		3.3
	IODIDE	8.6		0.75	4.5		0.75	3.3		0.75	3.9		0.75
	NITRATE	NS	--	--	ND	U	0.5	ND	U	0.2	ND	U	1
	NITRITE	NS	--	--	ND	U	0.5	ND	U	0.2	ND	U	1
	NITROGEN, NITRATE-NITRITE	ND	U	0.375	NS	--	--	NS	--	--	NS	--	--
	O-PHOSPHATE (AS P)	10.8		0.5	8.66		0.2	6.64		0.2	0.624		0.02
	ORTHOPHOSPHATE	NS	--	--	NS	--	--	NS	--	--	NS	--	--
	PHOSPHORUS	NS	--	--	NS	--	--	NS	--	--	NS	--	--
	SULFATE	ND	U	10	ND	U	5	ND	U	2	ND	U	10

Table 11
Analytical Data Table for KAFB-106IN1

Phase Designation		Phase 2 Passive											
Sample ID		106IN1-P2P-030718			106IN1-P2P-041118			106IN1-P2P-050918			106IN1-P2P-061418		
Sample Date		3/7/2018			4/11/2018			5/9/2018			6/14/2018		
Sample Purpose		REG			REG			REG			REG		
Chemical Class and Analytical Method ^a	Parameter	Result	Val Qual	LOQ	Result	Val Qual	LOQ	Result	Val Qual	LOQ	Result	Val Qual	LOQ
Metals (mg/L) EPA Method 6010	LEAD	NS	--	--	NS	--	--	NS	--	--	NS	--	--
Dissolved Metals (mg/L) EPA Method 6010	IRON	18.7		0.06	20.2	J-	0.06	26.4		0.06	25.3		0.06
	MANGANESE	6.4		0.006	5.37	J+	0.006	5.57		0.006	5.54		0.006
δ2H (‰) Mass Spectrometry, USGS Reston, VA	DELTA2H	NS	--	--	NS	--	--	NS	--	--	NS	--	--
CSIA EDB δ13C (‰) Kuder et al, 2012	EDB δ	NS	--	--	NS	--	--	NS	--	--	NS	--	--
VOCs (µg/L) EPA Method 8260	1,1,2-TRICHLOROETHANE	ND	U	50	ND	U	2.5	ND	U	50	ND	U	25
	1,2,4-TRICHLOROBENZENE	NS	--	--	NS	--	--	NS	--	--	NS	--	--
	1,2,4-TRIMETHYLBENZENE	271		50	286		2.5	309		50	261		25
	1,2-DIBROMOETHANE	ND	U	50	ND	U	2.5	ND	U	50	ND	U	25
	1,2-DICHLOROETHANE	ND	U	50	2.57	J	2.5	ND	U	50	ND	U	25
	1,3,5-TRIMETHYLBENZENE	104		50	106		2.5	110		50	89.2		25
	2-BUTANONE	ND	U	500	128		25	ND	U	500	ND	U	250
	2-CHLOROTOLUENE	ND	U	50	ND	U	2.5	ND	U	50	ND	U	25
	2-HEXANONE	ND	U	250	145		12.5	ND	U	250	63.4	J	125
	4-METHYL-2-PENTANONE	147	J	250	181		12.5	157	J	250	172	J	125
	ACETONE	459	J	500	332		25	ND	U	500	132	J	250
	BENZENE	3660		50	2880		25	2990		50	3190		25
	CARBON DISULFIDE	ND	U	50	ND	U	2.5	ND	U	50	ND	U	25
	CHLOROMETHANE	ND	U	50	ND	U	2.5	ND	U	50	ND	U	25
	CIS-1,2-DICHLOROETHENE	NA	--	--	NA	--	--	NA	--	--	NA	--	--
	DICHLORODIFLUOROMETHANE	ND	U	100	ND	U	5	ND	U	100	ND	U	50
	ETHYLBENZENE	1750		50	976		2.5	1270		50	999		25
	ISOPROPYLBENZENE	147		50	194		2.5	238		50	216		25
	M,P-XYLENES	NA	--	--	NA	--	--	NA	--	--	NA	--	--
	METHYL TERT-BUTYL ETHER	ND	U	50	ND	U	2.5	ND	U	50	ND	U	25
	METHYLENE CHLORIDE	ND	U	100	ND	U	5	ND	U	100	ND	U	50
	NAPHTHALENE	67.4	J	50	132		2.5	122		50	96.2		25
	N-BUTYLBENZENE	ND	U	50	ND	U	2.5	ND	U	50	14	J	25
	N-PROPYLBENZENE	122		50	132		2.5	118		50	89.1		25
	O-XYLENE	NA	--	--	NA	--	--	NA	--	--	NA	--	--
	P-ISOPROPYLTOLUENE	ND	U	50	107		2.5	105		50	84		25
	SEC-BUTYLBENZENE	ND	U	50	15.6		2.5	ND	U	50	15.9	J	25
	TERT-BUTYLBENZENE	ND	U	50	ND	U	2.5	ND	U	50	ND	U	25
	TETRACHLOROETHENE	NA	--	--	NA	--	--	NA	--	--	NA	--	--
	TOLUENE	8330		50	6460	J-	25	6840		50	6470		25
	TRANS-1,2-DICHLOROETHENE	NA	--	--	NA	--	--	NA	--	--	NA	--	--
	TRICHLOROETHENE	ND	U	50	ND	U	2.5	ND	U	50	19.2	J	25
	TRICHLOROFUOROMETHANE	ND	U	100	ND	U	5	ND	U	100	ND	U	50
	VINYL CHLORIDE	NA	--	--	NA	--	--	NA	--	--	NA	--	--
	XYLENES	2620		150	2590	J-	75	2750		150	2550		75

Refer to notes at the end of the table.

Table 11
Analytical Data Table for KAFB-106IN1

Phase Designation		Phase 3 Passive						Phase 4 Passive					
Sample ID		106IN1-P3P-100418 ^d			106IN1-P3P-111918 ^d			106IN1-P4P-012119 ^d			106IN1-LTM-031220		
Sample Date		10/4/2018			11/19/2018			1/21/2019			3/12/2020		
Sample Purpose		REG			REG			REG			REG		
Chemical Class and Analytical Method ^a	Parameter	Result	Val Qual	LOQ	Result	Val Qual	LOQ	Result	Val Qual	LOQ	Result	Val Qual	LOQ
Microbial Community (cells/mL) QuantArray-Chlor	1,1 DCA Reductase (DCA)	NS	--	--	ND	U	192	ND	U	5.6	ND	U	78.1
	1,2 DCA Reductase (DCAR)	NS	--	--	ND	U	192	ND	U	5.6	ND	U	78.1
	BAV1 Vinyl Chloride Reductase (BVC)	NS	--	--	ND	U	19.2	ND	U	0.6	ND	U	7.8
	cer A Reductase	NS	--	--	ND	U	192	ND	U	5.6	ND	U	78.1
	Chloroform Reductase (CFR)	NS	--	--	ND	U	192	ND	U	5.6	ND	U	78.1
	Dehalobacter DCM (DCM)	NS	--	--	581000		192	21500		5.6	1540		78.1
	Dehalobacter spp. (DHBt)	NS	--	--	50200		192	786		5.6	236000		78.1
	Dehalobium chloroocercia (DECO)	NS	--	--	1710000		192	10300		5.6	71400		78.1
	Dehalococcoides (DHC)	NS	--	--	ND	U	19.2	ND	U	0.6	14.2		7.8
	Dehalogenimonas spp. (DHG)	NS	--	--	ND	U	192	ND	U	5.6	ND	U	78.1
	Desulfotobacterium spp. (DSB)	NS	--	--	83400		192	5250		5.6	119000		78.1
	Desulfuromonas spp. (DSM)	NS	--	--	731		192	ND	U	5.6	ND	U	78.1
	Dichloromethane Dehalogenase (DCMA)	NS	--	--	ND	U	192	ND	U	5.6	ND	U	78.1
	Epoxyalkane Transferase (EtnE)	NS	--	--	ND	U	192	ND	U	5.6	2590		78.1
	Ethene Monooxygenase (EtnC)	NS	--	--	ND	U	192	ND	U	5.6	ND	U	78.1
	Methanogens (MGN)	NS	--	--	161	J	192	13900		5.6	ND	U	78.1
	PCE Reductase (PCE-1)	NS	--	--	ND	U	192	ND	U	5.6	ND	U	78.1
	Phenol Hydroxylase (PHE)	NS	--	--	638000		192	14400		5.6	23900		78.1
	PMMO	NS	--	--	NS	--	--	NS	--	--	NA	--	--
	Soluble Methane Monooxygenase (SMMO)	NS	--	--	ND	U	192	ND	U	5.6	ND	U	78.1
	Sulfate Reducing Bacteria (APS)	NS	--	--	10500000		192	18100		5.6	513000		78.1
	tceA Reductase (TCE)	NS	--	--	ND	U	19.2	ND	U	0.6	2.2	J	7.8
	Toluene Dioxygenase (TOD)	NS	--	--	337		192	54.1		5.6	ND	U	78.1
	Toluene Monooxygenase (RMO)	NS	--	--	340000		192	17200		5.6	32400		78.1
	Toluene Monooxygenase 2 (RDEG)	NS	--	--	652000		192	16900		5.6	41700		78.1
Total Eubacteria (EBAC)	NS	--	--	780000000		192	16100000		5.6	445000000		78.1	
trans-1,2-DCE Reductase (TDR)	NS	--	--	ND	U	192	ND	U	5.6	ND	U	78.1	
Trichlorobenzene Dioxygenase (TCBO)	NS	--	--	4660		192	70.6		5.6	ND	U	78.1	
Vinyl Chloride Reductase (VCR)	NS	--	--	ND	U	19.2	ND	U	0.6	ND	U	7.8	
EDB (µg/L) EPA Method 8011	1,2-DIBROMOETHANE	0.38		0.0016	0.049	J	0.00029	0.032		0.0003	ND	U	0.011
VFAs (mg/L) EPA Method 300m	ACETIC ACID	484.1		10	ND	U	1	ND	U	1	1	J	10
	BUTYRIC ACID	44.2		10	ND	U	1	ND	U	1	ND	U	1
	FORMIC ACID	29		10	0.4	J	1	ND	U	1	0.7	J	10
	LACTIC ACID	ND	U	1	0.9	J	1	ND	U	1	1	J	10
	PROPIONIC ACID	304.6		10	ND	U	1	ND	U	1	ND	U	1
	PYRUVIC ACID	85.1		10	ND	U	1	ND	U	1	ND	U	1
	VALERIC ACID	8.3	J	10	ND	U	1	ND	U	1	ND	U	1
Fluorometric (µg/L) Spectrofluorophotometry	FLUORESCCEIN	NS	--	--	NS	--	--	NS	--	--	NS	--	--
Reduced Gases (µg/L) RSKSOP-175	ACETYLENE	ND	U	10	ND	U	10	ND	U	10	ND	U	10
	ETHANE	ND	U	4	ND	U	4	ND	U	4	ND	U	4
	ETHYLENE	1.1	J	5	ND	U	5	ND	U	5	ND	U	5
	METHANE	9209.1		2	6278.9		2	8581.4		2	1586.5		2
	PROPANE	ND	U	6	ND	U	6	ND	U	6	ND	U	6
General Chemistry (mg/L) SM2320b, EPA Method 300, EPA Method 353.2, SM4500 Pec	ALKALINITY	1000		5	2100		5	1400		5	2260		5
	BROMIDE	3.8		1	2.3	J	5	1.1		0.5	1.16		0.1
	CHLORIDE	64		1	69		5	81		0.5	79.7		0.5
	IODIDE	4		1.5	4.3		1.5	3.3	J+	1.5	3.7		0.2
	NITRATE	NS	--	--	NS	--	--	NS	--	--	0.113		0.1
	NITRITE	NS	--	--	NS	--	--	NS	--	--	NS	--	--
	NITROGEN, NITRATE-NITRITE	ND	U	0.1	ND	U	0.5	ND	UJ	0.05	ND	U	0.1
	O-PHOSPHATE (AS P)	NS	--	--	NS	--	--	NS	--	--	NS	--	--
	ORTHOPHOSPHATE	12		0.75	9.9	J-	0.75	4.1	J-	0.75	NS	--	--
	PHOSPHORUS	NS	--	--	NS	--	--	NS	--	--	3.84		0.125
	SULFATE	6.4		2	ND	U	10	ND	U	1	1.52		0.5

Table 11
Analytical Data Table for KAFB-106IN1

Phase Designation		Phase 3 Passive						Phase 4 Passive					
Sample ID		106IN1-P3P-100418 ^d			106IN1-P3P-111918 ^d			106IN1-P4P-012119 ^d			106IN1-LTM-031220		
Sample Date		10/4/2018			11/19/2018			1/21/2019			3/12/2020		
Sample Purpose		REG			REG			REG			REG		
Chemical Class and Analytical Method ^a	Parameter	Result	Val Qual	LOQ	Result	Val Qual	LOQ	Result	Val Qual	LOQ	Result	Val Qual	LOQ
Metals (mg/L) EPA Method 6010	LEAD	NS	--	--	NS	--	--	NS	--	--	0.00462	J	0.001
Dissolved Metals (mg/L) EPA Method 6010	IRON	14		0.05	7.9		0.05	8.4		0.05	7.08		0.05
	MANGANESE	9.7		0.003	8		0.003	6.3		0.003	6.17		0.125
δ2H (‰) Mass Spectrometry, USGS Reston, VA	DELTA2H	NS	--	--	NS	--	--	NS	--	--	NS	--	--
CSIA EDB δ13C (‰) Kuder et al, 2012	EDB δ	NS	--	--	NS	--	--	NS	--	--	NS	--	--
VOCs (µg/L) EPA Method 8260	1,1,2-TRICHLOROETHANE	ND	U	25	ND	U	50	ND	U	5	ND	U	2.5
	1,2,4-TRICHLOROBENZENE	NS	--	--	NS	--	--	NS	--	--	ND	U	2.5
	1,2,4-TRIMETHYLBENZENE	220		50	180		100	190		10	NA	--	--
	1,2-DIBROMOETHANE	ND	U	50	ND	U	100	ND	U	10	ND	U	2.5
	1,2-DICHLOROETHANE	ND	U	50	ND	U	100	NA	--	--	ND	U	2.5
	1,3,5-TRIMETHYLBENZENE	78		25	65	J	50	63		5	33		2.5
	2-BUTANONE	200	J	500	ND	U	1000	ND	U	100	ND	U	5
	2-CHLOROTOLUENE	ND	U	25	ND	U	50	ND	U	5	ND	U	2.5
	2-HEXANONE	ND	U	250	ND	U	500	39	J	50	ND	U	5
	4-METHYL-2-PENTANONE	110	J	250	ND	U	500	110		50	ND	U	5
	ACETONE	750		500	ND	U	1000	ND	U	100	ND	U	5
	BENZENE	1800		50	860		100	750		10	630		2.5
	CARBON DISULFIDE	ND	U	100	ND	U	200	ND	U	20	ND	U	5
	CHLOROMETHANE	ND	U	50	ND	U	100	ND	U	10	ND	U	2.5
	CIS-1,2-DICHLOROETHENE	NA	--	--	NA	--	--	NA	--	--	ND	U	2.5
	DICHLORODIFLUOROMETHANE	ND	U	50	ND	U	100	NA	--	--	ND	U	2.5
	ETHYLBENZENE	760		50	670		100	NA	--	--	260		2.5
	ISOPROPYLBENZENE	100		50	95	J	100	83		10	57		2.5
	M,P-XYLENES	NA	--	--	NA	--	--	NA	--	--	420		5
	METHYL TERT-BUTYL ETHER	ND	U	25	ND	U	50	4.5	J	5	ND	U	2.5
	METHYLENE CHLORIDE	ND	U	250	ND	U	500	ND	U	50	ND	U	5
	NAPHTHALENE	ND	U	250	ND	U	500	86		50	44		2.5
	N-BUTYLBENZENE	ND	U	50	ND	U	100	9.1	J	10	ND	U	2.5
	N-PROPYLBENZENE	78		50	70	J	100	61		10	38		2.5
	O-XYLENE	NA	--	--	NA	--	--	NA	--	--	230		2.5
	P-ISOPROPYLTOLUENE	51		50	ND	U	100	43		10	ND	U	2.5
	SEC-BUTYLBENZENE	ND	U	50	ND	U	100	8.8	J	10	ND	U	2.5
	TERT-BUTYLBENZENE	ND	U	50	ND	U	100	ND	U	10	ND	U	2.5
	TETRACHLOROETHENE	NA	--	--	NA	--	--	NA	--	--	ND	U	2.5
	TOLUENE	4900		50	3300		100	1400		25	29		2.5
	TRANS-1,2-DICHLOROETHENE	NA	--	--	NA	--	--	NA	--	--	ND	U	2.5
	TRICHLOROETHENE	ND	U	50	ND	U	100	ND	U	10	ND	U	2.5
	TRICHLOROFUOROMETHANE	ND	U	50	ND	U	100	ND	U	10	ND	U	2.5
	VINYL CHLORIDE	NA	--	--	NA	--	--	NA	--	--	ND	U	2.5
	XYLENES	2100		25	1800		50	1400		5	650		2.5

Refer to notes at the end of the table.

Table 11
Analytical Data Table for KAFB-106IN1

Phase Designation		Phase 4 Passive											
Sample ID		106IN1-LTM-051920			106IN1-LTM-080420			106IN1-LTM-080420-FD			106IN1-LTM-102820		
Sample Date		5/19/2020			8/4/2020			8/4/2020			10/28/2020		
Sample Purpose		REG			REG			FD			REG		
Chemical Class and Analytical Method ^a	Parameter	Result	Val Qual	LOQ	Result	Val Qual	LOQ	Result	Val Qual	LOQ	Result	Val Qual	LOQ
Microbial Community (cells/mL) QuantArray-Chlor	1,1 DCA Reductase (DCA)	ND	U	73.5	ND	U	69.4	NS	--	--	92.6		92.6
	1,2 DCA Reductase (DCAR)	ND	U	73.5	ND	U	69.4	NS	--	--	92.6		92.6
	BAV1 Vinyl Chloride Reductase (BVC)	ND	U	7.4	ND	U	6.9	NS	--	--	9.3		9.3
	cer A Reductase	ND	U	73.5	ND	U	69.4	NS	--	--	92.6		92.6
	Chloroform Reductase (CFR)	ND	U	73.5	ND	U	69.4	NS	--	--	92.6		92.6
	Dehalobacter DCM (DCM)	2560		73.5	ND	U	69.4	NS	--	--	3220		92.6
	Dehalobacter spp. (DHBt)	19200		73.5	ND	U	69.4	NS	--	--	13100		92.6
	Dehalobium chloroocercia (DECO)	38700		73.5	47500		69.4	NS	--	--	69200		92.6
	Dehalococcoides (DHC)	224		7.4	ND	U	6.9	NS	--	--	15.3		9.3
	Dehalogenimonas spp. (DHG)	ND	U	73.5	ND	U	69.4	NS	--	--	92.6		92.6
	Desulfotobacterium spp. (DSB)	241000		73.5	56800		69.4	NS	--	--	11400		92.6
	Desulfuromonas spp. (DSM)	ND	U	73.5	ND	U	69.4	NS	--	--	92.6		92.6
	Dichloromethane Dehalogenase (DCMA)	ND	U	73.5	ND	U	69.4	NS	--	--	92.6		92.6
	Epoxyalkane Transferase (EtnE)	1180		73.5	ND	U	69.4	NS	--	--	1510		92.6
	Ethene Monooxygenase (EtnC)	ND	U	73.5	ND	U	69.4	NS	--	--	92.6		92.6
	Methanogens (MGN)	13400		73.5	459000		69.4	NS	--	--	92.6		92.6
	PCE Reductase (PCE-1)	ND	U	73.5	ND	U	69.4	NS	--	--	92.6		92.6
	Phenol Hydroxylase (PHE)	33100		73.5	19900		69.4	NS	--	--	18700		92.6
	PMMO	NA	--	--	NA	--	--	NS	--	--	NA	--	--
	Soluble Methane Monooxygenase (SMMO)	ND	U	73.5	ND	U	69.4	NS	--	--	92.6		92.6
	Sulfate Reducing Bacteria (APS)	903000		73.5	574000		69.4	NS	--	--	1420000		92.6
	tceA Reductase (TCE)	10.8		7.4	ND	U	6.9	NS	--	--	9.3		9.3
	Toluene Dioxygenase (TOD)	ND	U	73.5	ND	U	69.4	NS	--	--	92.6		92.6
	Toluene Monooxygenase (RMO)	27400		73.5	16400		69.4	NS	--	--	21300		92.6
	Toluene Monooxygenase 2 (RDEG)	38700		73.5	26300		69.4	NS	--	--	59900		92.6
	Total Eubacteria (EBAC)	612000000		73.5	231000000		69.4	NS	--	--	547000000		92.6
	trans-1,2-DCE Reductase (TDR)	ND	U	73.5	ND	U	69.4	NS	--	--	92.6		92.6
	Trichlorobenzene Dioxygenase (TCBO)	ND	U	73.5	ND	U	69.4	NS	--	--	92.6		92.6
Vinyl Chloride Reductase (VCR)	ND	U	7.4	ND	U	6.9	NS	--	--	9.3		9.3	
EDB (µg/L) EPA Method 8011	1,2-DIBROMOETHANE	ND	U	0.01	ND	U	0.011	ND	U	0.01	ND	U	0.011
VFAs (mg/L) EPA Method 300m	ACETIC ACID	ND	U	10	ND	U	10	ND	U	10	6.1		10
	BUTYRIC ACID	ND	U	10	ND	U	10	ND	U	10	ND	U	10
	FORMIC ACID	ND	U	10	4.1	J	10	4.6	J	10	4.2	J	10
	LACTIC ACID	ND	U	10	ND	U	10	ND	U	10	0.7	J	10
	PROPIONIC ACID	ND	U	10	ND	U	10	ND	U	10	ND	U	10
	PYRUVIC ACID	ND	U	10	ND	U	10	ND	U	10	ND	U	10
	VALERIC ACID	ND	U	10	ND	U	10	ND	U	10	ND	U	10
Fluorometric (µg/L) Spectrofluorophotometry	FLUORESCCEIN	NS	--	--	NS	--	--	NS	--	--	NS	--	--
Reduced Gases (µg/L) RSKSOP-175	ACETYLENE	ND	U	10	ND	U	10	ND	U	10	ND	U	10
	ETHANE	ND	U	4	ND	U	4	ND	U	4	ND	U	4
	ETHYLENE	ND	U	5	ND	U	5	ND	U	5	ND	U	5
	METHANE	4339.3		2	4693.6		2	3841.8		2	7519.3		2
	PROPANE	ND	U	6	ND	U	6	ND	U	6	ND	U	6
General Chemistry (mg/L) SM2320b, EPA Method 300, EPA Method 353.2, SM4500 Pec	ALKALINITY	2270		5	2340		5	2290		5	2150		5
	BROMIDE	0.96		0.1	1.24		0.1	1.31		0.1	0.982		0.1
	CHLORIDE	75.8		0.5	75.6		0.5	76.9		0.5	67.3		0.5
	IODIDE	3.3		0.2	4.3		2	5.1		2	2.6		
	NITRATE	0.0667	J	0.1	0.0479	J	0.1	0.0565	J	0.1	0.052	J-	0.1
	NITRITE	NS	--	--	NS	--	--	NS	--	--	NS	--	--
	NITROGEN, NITRATE-NITRITE	ND	U	0.1	ND	U	0.1	ND	U	0.1	ND	UJ	0.1
	O-PHOSPHATE (AS P)	NS	--	--	NS	--	--	NS	--	--	NS	--	--
	ORTHOPHOSPHATE	NS	--	--	NS	--	--	NS	--	--	NS	--	--
	PHOSPHORUS	7.45		0.25	7.39		0.25	7.43		0.25	3.68	J-	0.25
	SULFATE	1.02		0.5	1.35		0.5	1.48		0.5	2.3		0.5

Table 11
Analytical Data Table for KAFB-106IN1

Phase Designation		Phase 4 Passive											
Sample ID		106IN1-LTM-051920			106IN1-LTM-080420			106IN1-LTM-080420-FD			106IN1-LTM-102820		
Sample Date		5/19/2020			8/4/2020			8/4/2020			10/28/2020		
Sample Purpose		REG			REG			FD			REG		
Chemical Class and Analytical Method ^a	Parameter	Result	Val Qual	LOQ	Result	Val Qual	LOQ	Result	Val Qual	LOQ	Result	Val Qual	LOQ
Metals (mg/L) EPA Method 6010	LEAD	0.00438	J	0.001	0.00446	J	0.001	0.0052		0.001	0.00587		0.001
Dissolved Metals (mg/L) EPA Method 6010	IRON	5.58		0.05	5.45		0.05	4.6		0.05	1.09		0.05
	MANGANESE	6.2		0.125	6.3		0.125	5.51		0.125	5.61		0.125
δ2H (‰) Mass Spectrometry, USGS Reston, VA	DELTA2H	NS	--	--	NS	--	--	NS	--	--	NS	--	--
CSIA EDB δ13C (‰) Kuder et al, 2012	EDB δ	NS	--	--	NS	--	--	NS	--	--	NS	--	--
VOCs (µg/L) EPA Method 8260	1,1,2-TRICHLOROETHANE	ND	U	5	ND	U	5	ND	U	5	ND	U	1
	1,2,4-TRICHLOROBENZENE	ND	U	5	ND	U	5	ND	U	5	ND	U	1
	1,2,4-TRIMETHYLBENZENE	NA	--	--	NA	--	--	NA	--	--	NA	--	--
	1,2-DIBROMOETHANE	ND	U	2.5	ND	U	2.5	ND	U	2.5	ND	U	0.5
	1,2-DICHLOROETHANE	ND	U	2.5	ND	U	2.5	ND	U	2.5	ND	U	0.5
	1,3,5-TRIMETHYLBENZENE	32		5	35		5	37		5	52	J+	0.5
	2-BUTANONE	ND	U	5	ND	U	5	ND	U	5	3.5	J+	1
	2-CHLOROTOLUENE	ND	U	5	ND	U	5	ND	U	5	ND	U	1
	2-HEXANONE	ND	U	10	ND	U	10	ND	U	10	ND	U	2
	4-METHYL-2-PENTANONE	ND	U	10	ND	U	10	ND	U	10	ND	U	2
	ACETONE	ND	U	5	38		5	41		5	24	J+	1
	BENZENE	590		2.5	760		2.5	780		2.5	1000		12
	CARBON DISULFIDE	ND	U	5	ND	U	5	ND	U	5	ND	U	2
	CHLOROMETHANE	ND	U	2.5	ND	U	2.5	ND	U	2.5	ND	U	0.5
	CIS-1,2-DICHLOROETHENE	ND	U	2.5	ND	U	2.5	ND	U	2.5	ND	U	0.5
	DICHLORODIFLUOROMETHANE	ND	U	5	ND	U	5	ND	U	5	ND	U	0.5
	ETHYLBENZENE	250		5	290		5	300		5	370		25
	ISOPROPYLBENZENE	58		5	69		5	73		5	110	J+	0.5
	M,P-XYLENES	400		5	460		5	470		5	630		25
	METHYL TERT-BUTYL ETHER	ND	U	2.5	ND	U	2.5	ND	U	2.5	1.5	J+	0.5
	METHYLENE CHLORIDE	ND	U	5	ND	U	5	ND	U	5	ND	U	1
	NAPHTHALENE	68		5	57		5	57		5	68	J+	0.5
	N-BUTYLBENZENE	5.6		5	5.4		5	5.9		5	ND	U	1
	N-PROPYLBENZENE	38		5	44		5	47		5	72	J+	1
	O-XYLENE	220		5	240		5	250		5	310		12
	P-ISOPROPYLTOLUENE	35		5	33		5	36		5	56	J+	1
	SEC-BUTYLBENZENE	6		5	6.5		5	7		5	12	J+	1
	TERT-BUTYLBENZENE	ND	U	5	ND	U	5	ND	U	5	ND	U	0.5
	TETRACHLOROETHENE	ND	U	5	ND	U	5	ND	U	5	ND	U	1
	TOLUENE	11		2.5	6.1		2.5	6.3		2.5	5.2	J+	0.5
	TRANS-1,2-DICHLOROETHENE	ND	U	2.5	ND	U	2.5	ND	U	2.5	ND	U	0.5
	TRICHLOROETHENE	ND	U	2.5	ND	U	2.5	ND	U	2.5	ND	U	0.5
	TRICHLOROFUOROMETHANE	ND	U	5	ND	U	5	ND	U	5	ND	U	0.5
	VINYL CHLORIDE	ND	U	2.5	ND	U	2.5	ND	U	2.5	ND	U	0.5
	XYLENES	610		5	710		5	730		5	930		25

Refer to notes at the end of the table.

Table 11
Analytical Data Table for KAFB-106IN1

Notes:

Sampling frequency for each analytical method is outlined in Table 4.

- a. EPA analytical methods listed are for the most recent sampling event.
- b. Samples were collected using Geotech Bladder Pumps.
- c. Samples were recollected (except for QuantArray-Chlor analysis) using replacement QED Bladder Pumps.
- d. Sample was collected from sound tube using a stainless steel bailer.

-- = Not applicable.

δ2H - Delta Deuterium.

0/00 - Per mil.

cells/mL = Cells per milliliter.

EPA = Environmental Protection Agency.

FD = Field duplicate.

ID = Identification.

J = Estimated value, concentration is less than LOQ but greater than laboratory method detection limit (DL).

J+ = Estimated value, concentration is less than LOQ but greater than laboratory method detection limit (DL); biased high.

J- = Estimated value, concentration is less than LOQ but greater than laboratory method detection limit (DL); biased low.

KAFB = Kirtland Air Force Base.

LOQ = Limit of Quantitation

µg/L = Microgram per liter.

mg/L = Milligram per liter.

NA = Not analyzed.

ND = Not detected.

NS = Not sampled.

REG = Regular/parent sample.

U = Analyte was not detected. The reported numerical value is at or below the LOQ.

UJ = Analyte was not detected. The reported value is estimated.

VAL QUAL = Validation qualifier.

VFA - Volatile fatty acid.

VOC = Volatile organic compound.

Table 12
Analytical Data Table for KAFB-106MW1-I

Phase Designation		Original Baseline ^b			New Baseline - QED Pumps ^c			Phase 1 Recirculation					
Sample ID		106MW11-BL-071817			106MW11-BL-091817			106MW11-P1R-100417			106MW11-P1R-100617		
Sample Date		7/18/2017			9/18/2017			10/4/2017			10/6/2017		
Sample Purpose		REG			REG			REG			REG		
Chemical Class and Analytical Method ^a	Parameter	Result	Val Qual	LOQ	Result	Val Qual	LOQ	Result	Val Qual	LOQ	Result	Val Qual	LOQ
Microbial Community (cells/mL) QuantArray-Chlor	1,1 DCA Reductase (DCA)	ND	U	4.8	NS	--	--	NS	--	--	NS	--	--
	1,2 DCA Reductase (DCAR)	ND	U	4.8	NS	--	--	NS	--	--	NS	--	--
	BAV1 Vinyl Chloride Reductase (BVC)	ND	U	0.5	NS	--	--	NS	--	--	NS	--	--
	cer A Reductase	NA	--	--	NS	--	--	NS	--	--	NS	--	--
	Chloroform Reductase (CFR)	ND	U	4.8	NS	--	--	NS	--	--	NS	--	--
	Dehalobacter DCM (DCM)	ND	U	4.8	NS	--	--	NS	--	--	NS	--	--
	Dehalobacter spp. (DHBt)	5170		4.8	NS	--	--	NS	--	--	NS	--	--
	Dehalobium chlorocoercia (DECO)	5830		4.8	NS	--	--	NS	--	--	NS	--	--
	Dehalococcoides (DHC)	ND	U	0.5	NS	--	--	NS	--	--	NS	--	--
	Dehalogenimonas spp. (DHG)	ND	U	4.8	NS	--	--	NS	--	--	NS	--	--
	Desulfotobacterium spp. (DSB)	2980		4.8	NS	--	--	NS	--	--	NS	--	--
	Desulfuromonas spp. (DSM)	9.8		4.8	NS	--	--	NS	--	--	NS	--	--
	Dichloromethane Dehalogenase (DCMA)	ND	U	4.8	NS	--	--	NS	--	--	NS	--	--
	Epoxyalkane Transferase (EtnE)	ND	U	4.8	NS	--	--	NS	--	--	NS	--	--
	Ethene Monooxygenase (EtnC)	ND	U	4.8	NS	--	--	NS	--	--	NS	--	--
	Methanogens (MGN)	115		4.8	NS	--	--	NS	--	--	NS	--	--
	PCE Reductase (PCE-1)	NA	--	--	NS	--	--	NS	--	--	NS	--	--
	Phenol Hydroxylase (PHE)	2870		4.8	NS	--	--	NS	--	--	NS	--	--
	PMMO	14.9		4.8	NS	--	--	NS	--	--	NS	--	--
	Soluble Methane Monooxygenase (SMMO)	930		4.8	NS	--	--	NS	--	--	NS	--	--
	Sulfate Reducing Bacteria (APS)	2470		4.8	NS	--	--	NS	--	--	NS	--	--
	tceA Reductase (TCE)	ND	U	0.5	NS	--	--	NS	--	--	NS	--	--
	Toluene Dioxygenase (TOD)	482		4.8	NS	--	--	NS	--	--	NS	--	--
Toluene Monooxygenase (RMO)	0.7	J	4.8	NS	--	--	NS	--	--	NS	--	--	
Toluene Monooxygenase 2 (RDEG)	6730		4.8	NS	--	--	NS	--	--	NS	--	--	
Total Eubacteria (EBAC)	862000		4.8	NS	--	--	NS	--	--	NS	--	--	
trans-1,2-DCE Reductase (TDR)	NA	--	--	NS	--	--	NS	--	--	NS	--	--	
Trichlorobenzene Dioxygenase (TCBO)	2740		4.8	NS	--	--	NS	--	--	NS	--	--	
Vinyl Chloride Reductase (VCR)	ND	U	0.5	NS	--	--	NS	--	--	NS	--	--	
EDB (µg/L) EPA Method 8011	1,2-DIBROMOETHANE	ND	UJ	0.0191	ND	UJ	0.0191	NS	--	--	NS	--	--
VFAs (mg/L) EPA Method 300m	ACETIC ACID	ND	U	1	1.22		1	NS	--	--	NS	--	--
	BUTYRIC ACID	ND	U	1	ND	U	1	NS	--	--	NS	--	--
	FORMIC ACID	ND	U	1	ND	U	1	NS	--	--	NS	--	--
	LACTIC ACID	ND	U	1	ND	U	1	NS	--	--	NS	--	--
	PROPIONIC ACID	ND	U	1	ND	U	1	NS	--	--	NS	--	--
	PYRUVIC ACID	ND	U	1	ND	U	1	NS	--	--	NS	--	--
VALERIC ACID	ND	U	1	ND	U	1	NS	--	--	NS	--	--	
Fluorometric (µg/L) Spectrofluorophotometry	FLUORESC EIN	ND	U	0.01	ND	U	0.01	ND	U	0.01	ND	U	0.01
Reduced Gases (µg/L) RSKSOP-175	ACETYLENE	ND	U	10	ND	U	10	NS	--	--	NS	--	--
	ETHANE	ND	U	4	ND	U	4	NS	--	--	NS	--	--
	ETHYLENE	ND	U	5	ND	U	5	NS	--	--	NS	--	--
	METHANE	ND	U	2	ND	U	2	NS	--	--	NS	--	--
	PROPANE	ND	U	6	ND	U	6	NS	--	--	NS	--	--
General Chemistry (mg/L) SM2320b, EPA Method 300, EPA Method 353.2, SM4500 Pec	ALKALINITY	146		1	182		1	NS	--	--	NS	--	--
	BROMIDE	0.424		0.125	0.409		0.125	NS	--	--	NS	--	--
	CHLORIDE	37.5		0.33	40.1		0.33	NS	--	--	NS	--	--
	IODIDE	ND	U	0.2	ND	U	0.75	NS	--	--	NS	--	--
	NITRATE	NA	--	--	NA	--	--	NS	--	--	NS	--	--
	NITRITE	NA	--	--	NA	--	--	NS	--	--	NS	--	--
	NITROGEN, NITRATE-NITRITE	ND	U	0.375	ND	U	0.375	NS	--	--	NS	--	--
	O-PHOSPHATE (AS P)	0.0142		0.02	ND	U	0.02	NS	--	--	NS	--	--
	ORTHOPHOSPHATE	NA	--	--	NA	--	--	NS	--	--	NS	--	--
	PHOSPHORUS	NA	--	--	NA	--	--	NS	--	--	NS	--	--
SULFATE	27.6		1	23.8		1	NS	--	--	NS	--	--	

Table 12
Analytical Data Table for KAFB-106MW1-I

Phase Designation		Original Baseline ^b			New Baseline - QED Pumps ^c			Phase 1 Recirculation					
Sample ID		106MW11-BL-071817			106MW11-BL-091817			106MW11-P1R-100417			106MW11-P1R-100617		
Sample Date		7/18/2017			9/18/2017			10/4/2017			10/6/2017		
Sample Purpose		REG			REG			REG			REG		
Chemical Class and Analytical Method ^a	Parameter	Result	Val Qual	LOQ	Result	Val Qual	LOQ	Result	Val Qual	LOQ	Result	Val Qual	LOQ
Metals (mg/L) EPA Method 6010	LEAD	NS	--	--	NS	--	--	NS	--	--	NS	--	--
Dissolved Metals (mg/L) EPA Method 6010	IRON	ND	U	0.06	ND	UJ	0.06	NS	--	--	NS	--	--
	MANGANESE	0.0363		0.006	0.0293	J-	0.006	NS	--	--	NS	--	--
δ2H (‰) Mass Spectrometry, USGS Reston, VA	DELTA2H	-97.11		-99	-94.92		-99	-95.52		-99	-96.51		-99
VOCs (µg/L) EPA Method 8260	1,1,2-TRICHLOROETHANE	ND	U	1	ND	U	1	NS	--	--	NS	--	--
	1,2,4-TRICHLOROBENZENE	NA	--	--	NA	--	--	NS	--	--	NS	--	--
	1,2,4-TRIMETHYLBENZENE	ND	U	1	ND	U	1	NS	--	--	NS	--	--
	1,2-DIBROMOETHANE	ND	U	1	ND	U	1	NS	--	--	NS	--	--
	1,2-DICHLOROETHANE	1.22	J	1	1.12	J	1	NS	--	--	NS	--	--
	1,3,5-TRIMETHYLBENZENE	1.15	J	1	ND	U	1	NS	--	--	NS	--	--
	2-BUTANONE	ND	U	10	ND	U	10	NS	--	--	NS	--	--
	2-CHLOROTOLUENE	ND	U	1	ND	U	1	NS	--	--	NS	--	--
	2-HEXANONE	ND	U	5	ND	U	5	NS	--	--	NS	--	--
	4-METHYL-2-PENTANONE	ND	U	5	ND	U	5	NS	--	--	NS	--	--
	ACETONE	35.5		10	22.5		10	NS	--	--	NS	--	--
	BENZENE	ND	U	1	ND	U	1	NS	--	--	NS	--	--
	CARBON DISULFIDE	ND	U	1	ND	U	1	NS	--	--	NS	--	--
	CHLOROMETHANE	ND	U	1	ND	U	1	NS	--	--	NS	--	--
	CIS-1,2-DICHLOROETHENE	NA	--	--	NA	--	--	NS	--	--	NS	--	--
	DICHLORODIFLUOROMETHANE	ND	U	2	ND	U	2	NS	--	--	NS	--	--
	ETHYLBENZENE	ND	U	1	ND	U	1	NS	--	--	NS	--	--
	ISOPROPYLBENZENE	12.9		1	1.91	J	1	NS	--	--	NS	--	--
	M,P-XYLENES	NA	--	--	NA	--	--	NS	--	--	NS	--	--
	METHYL TERT-BUTYL ETHER	0.655	J	1	ND	U	1	NS	--	--	NS	--	--
	METHYLENE CHLORIDE	ND	U	2	ND	U	2	NS	--	--	NS	--	--
	NAPHTHALENE	ND	U	1	ND	U	1	NS	--	--	NS	--	--
	N-BUTYLBENZENE	ND	U	1	ND	U	1	NS	--	--	NS	--	--
	N-PROPYLBENZENE	ND	U	1	ND	U	1	NS	--	--	NS	--	--
	O-XYLENE	NA	--	--	NA	--	--	NS	--	--	NS	--	--
	P-ISOPROPYLTOLUENE	2.02		1	ND	U	1	NS	--	--	NS	--	--
	SEC-BUTYLBENZENE	ND	U	1	ND	U	1	NS	--	--	NS	--	--
	TERT-BUTYLBENZENE	ND	U	1	ND	U	1	NS	--	--	NS	--	--
	TETRACHLOROETHENE	NA	--	--	NA	--	--	NS	--	--	NS	--	--
	TOLUENE	0.642	J	1	0.612	J	1	NS	--	--	NS	--	--
	TRANS-1,2-DICHLOROETHENE	NA	--	--	NA	--	--	NS	--	--	NS	--	--
	TRICHLOROETHENE	ND	U	1	ND	U	1	NS	--	--	NS	--	--
	TRICHLOROFUOROMETHANE	ND	U	2	ND	U	2	NS	--	--	NS	--	--
	VINYL CHLORIDE	NA	--	--	NA	--	--	NS	--	--	NS	--	--
	XYLENES	ND	U	3	ND	U	3	NS	--	--	NS	--	--

Refer to notes at the end of the table.

Table 12
Analytical Data Table for KAFB-106MW1-I

Phase Designation		Phase 1 Recirculation											
Sample ID		106MW11-P1R-100917			106MW11-P1R-100917-FD			106MW11-P1R-101217			106MW11-P1R-101617		
Sample Date		10/9/2017			10/9/2017			10/12/2017			10/16/2017		
Sample Purpose		REG			FD			REG			REG		
Chemical Class and Analytical Method ^a	Parameter	Result	Val Qual	LOQ	Result	Val Qual	LOQ	Result	Val Qual	LOQ	Result	Val Qual	LOQ
Microbial Community (cells/mL) QuantArray-Chlor	1,1 DCA Reductase (DCA)	NS	--	--	NS	--	--	NS	--	--	NS	--	--
	1,2 DCA Reductase (DCAR)	NS	--	--	NS	--	--	NS	--	--	NS	--	--
	BAV1 Vinyl Chloride Reductase (BVC)	NS	--	--	NS	--	--	NS	--	--	NS	--	--
	cer A Reductase	NS	--	--	NS	--	--	NS	--	--	NS	--	--
	Chloroform Reductase (CFR)	NS	--	--	NS	--	--	NS	--	--	NS	--	--
	Dehalobacter DCM (DCM)	NS	--	--	NS	--	--	NS	--	--	NS	--	--
	Dehalobacter spp. (DHBt)	NS	--	--	NS	--	--	NS	--	--	NS	--	--
	Dehalobium chlorocoercia (DECO)	NS	--	--	NS	--	--	NS	--	--	NS	--	--
	Dehalococcoides (DHC)	NS	--	--	NS	--	--	NS	--	--	NS	--	--
	Dehalogenimonas spp. (DHG)	NS	--	--	NS	--	--	NS	--	--	NS	--	--
	Desulfotobacterium spp. (DSB)	NS	--	--	NS	--	--	NS	--	--	NS	--	--
	Desulfuromonas spp. (DSM)	NS	--	--	NS	--	--	NS	--	--	NS	--	--
	Dichloromethane Dehalogenase (DCMA)	NS	--	--	NS	--	--	NS	--	--	NS	--	--
	Epoxyalkane Transferase (EtnE)	NS	--	--	NS	--	--	NS	--	--	NS	--	--
	Ethene Monooxygenase (EtnC)	NS	--	--	NS	--	--	NS	--	--	NS	--	--
	Methanogens (MGN)	NS	--	--	NS	--	--	NS	--	--	NS	--	--
	PCE Reductase (PCE-1)	NS	--	--	NS	--	--	NS	--	--	NS	--	--
	Phenol Hydroxylase (PHE)	NS	--	--	NS	--	--	NS	--	--	NS	--	--
	PMMO	NS	--	--	NS	--	--	NS	--	--	NS	--	--
	Soluble Methane Monooxygenase (SMMO)	NS	--	--	NS	--	--	NS	--	--	NS	--	--
Sulfate Reducing Bacteria (APS)	NS	--	--	NS	--	--	NS	--	--	NS	--	--	
tceA Reductase (TCE)	NS	--	--	NS	--	--	NS	--	--	NS	--	--	
Toluene Dioxygenase (TOD)	NS	--	--	NS	--	--	NS	--	--	NS	--	--	
Toluene Monooxygenase (RMO)	NS	--	--	NS	--	--	NS	--	--	NS	--	--	
Toluene Monooxygenase 2 (RDEG)	NS	--	--	NS	--	--	NS	--	--	NS	--	--	
Total Eubacteria (EBAC)	NS	--	--	NS	--	--	NS	--	--	NS	--	--	
trans-1,2-DCE Reductase (TDR)	NS	--	--	NS	--	--	NS	--	--	NS	--	--	
Trichlorobenzene Dioxygenase (TCBO)	NS	--	--	NS	--	--	NS	--	--	NS	--	--	
Vinyl Chloride Reductase (VCR)	NS	--	--	NS	--	--	NS	--	--	NS	--	--	
EDB (µg/L) EPA Method 8011	1,2-DIBROMOETHANE	NS	--	--	NS	--	--	NS	--	--	NS	--	--
VFAs (mg/L) EPA Method 300m	ACETIC ACID	NS	--	--	NS	--	--	NS	--	--	NS	--	--
	BUTYRIC ACID	NS	--	--	NS	--	--	NS	--	--	NS	--	--
	FORMIC ACID	NS	--	--	NS	--	--	NS	--	--	NS	--	--
	LACTIC ACID	NS	--	--	NS	--	--	NS	--	--	NS	--	--
	PROPIONIC ACID	NS	--	--	NS	--	--	NS	--	--	NS	--	--
	PYRUVIC ACID	NS	--	--	NS	--	--	NS	--	--	NS	--	--
VALERIC ACID	NS	--	--	NS	--	--	NS	--	--	NS	--	--	
Fluorometric (µg/L) Spectrofluorophotometry	FLUORESC EIN	ND	U	0.01	ND	U	0.01	ND	U	0.01	ND	U	0.01
Reduced Gases (µg/L) RSKSOP-175	ACETYLENE	NS	--	--	NS	--	--	NS	--	--	NS	--	--
	ETHANE	NS	--	--	NS	--	--	NS	--	--	NS	--	--
	ETHYLENE	NS	--	--	NS	--	--	NS	--	--	NS	--	--
	METHANE	NS	--	--	NS	--	--	NS	--	--	NS	--	--
	PROPANE	NS	--	--	NS	--	--	NS	--	--	NS	--	--
General Chemistry (mg/L) SM2320b, EPA Method 300, EPA Method 353.2, SM4500 Pec	ALKALINITY	NS	--	--	NS	--	--	NS	--	--	NS	--	--
	BROMIDE	NS	--	--	NS	--	--	NS	--	--	NS	--	--
	CHLORIDE	NS	--	--	NS	--	--	NS	--	--	NS	--	--
	IODIDE	NS	--	--	NS	--	--	NS	--	--	NS	--	--
	NITRATE	NS	--	--	NS	--	--	NS	--	--	NS	--	--
	NITRITE	NS	--	--	NS	--	--	NS	--	--	NS	--	--
	NITROGEN, NITRATE-NITRITE	NS	--	--	NS	--	--	NS	--	--	NS	--	--
	O-PHOSPHATE (AS P)	NS	--	--	NS	--	--	NS	--	--	NS	--	--
	ORTHOPHOSPHATE	NS	--	--	NS	--	--	NS	--	--	NS	--	--
	PHOSPHORUS	NS	--	--	NS	--	--	NS	--	--	NS	--	--
SULFATE	NS	--	--	NS	--	--	NS	--	--	NS	--	--	

Table 12
Analytical Data Table for KAFB-106MW1-I

Phase Designation		Phase 1 Recirculation											
Sample ID		106MW1-P1R-100917			106MW1-P1R-100917-FD			106MW1-P1R-101217			106MW1-P1R-101617		
Sample Date		10/9/2017			10/9/2017			10/12/2017			10/16/2017		
Sample Purpose		REG			FD			REG			REG		
Chemical Class and Analytical Method ^a	Parameter	Result	Val Qual	LOQ	Result	Val Qual	LOQ	Result	Val Qual	LOQ	Result	Val Qual	LOQ
Metals (mg/L) EPA Method 6010	LEAD	NS	--	--	NS	--	--	NS	--	--	NS	--	--
Dissolved Metals (mg/L) EPA Method 6010	IRON	NS	--	--	NS	--	--	NS	--	--	NS	--	--
	MANGANESE	NS	--	--	NS	--	--	NS	--	--	NS	--	--
δ2H (‰) Mass Spectrometry, USGS Reston, VA	DELTA2H	-96.02		-99	-96.54		-99	-95.6		-99	-95.5		-99
VOCs (µg/L) EPA Method 8260	1,1,2-TRICHLOROETHANE	NS	--	--	NS	--	--	NS	--	--	NS	--	--
	1,2,4-TRICHLOROBENZENE	NS	--	--	NS	--	--	NS	--	--	NS	--	--
	1,2,4-TRIMETHYLBENZENE	NS	--	--	NS	--	--	NS	--	--	NS	--	--
	1,2-DIBROMOETHANE	NS	--	--	NS	--	--	NS	--	--	NS	--	--
	1,2-DICHLOROETHANE	NS	--	--	NS	--	--	NS	--	--	NS	--	--
	1,3,5-TRIMETHYLBENZENE	NS	--	--	NS	--	--	NS	--	--	NS	--	--
	2-BUTANONE	NS	--	--	NS	--	--	NS	--	--	NS	--	--
	2-CHLOROTOLUENE	NS	--	--	NS	--	--	NS	--	--	NS	--	--
	2-HEXANONE	NS	--	--	NS	--	--	NS	--	--	NS	--	--
	4-METHYL-2-PENTANONE	NS	--	--	NS	--	--	NS	--	--	NS	--	--
	ACETONE	NS	--	--	NS	--	--	NS	--	--	NS	--	--
	BENZENE	NS	--	--	NS	--	--	NS	--	--	NS	--	--
	CARBON DISULFIDE	NS	--	--	NS	--	--	NS	--	--	NS	--	--
	CHLOROMETHANE	NS	--	--	NS	--	--	NS	--	--	NS	--	--
	CIS-1,2-DICHLOROETHENE	NS	--	--	NS	--	--	NS	--	--	NS	--	--
	DICHLORODIFLUOROMETHANE	NS	--	--	NS	--	--	NS	--	--	NS	--	--
	ETHYLBENZENE	NS	--	--	NS	--	--	NS	--	--	NS	--	--
	ISOPROPYLBENZENE	NS	--	--	NS	--	--	NS	--	--	NS	--	--
	M,P-XYLENES	NS	--	--	NS	--	--	NS	--	--	NS	--	--
	METHYL TERT-BUTYL ETHER	NS	--	--	NS	--	--	NS	--	--	NS	--	--
	METHYLENE CHLORIDE	NS	--	--	NS	--	--	NS	--	--	NS	--	--
	NAPHTHALENE	NS	--	--	NS	--	--	NS	--	--	NS	--	--
	N-BUTYLBENZENE	NS	--	--	NS	--	--	NS	--	--	NS	--	--
	N-PROPYLBENZENE	NS	--	--	NS	--	--	NS	--	--	NS	--	--
	O-XYLENE	NS	--	--	NS	--	--	NS	--	--	NS	--	--
	P-ISOPROPYLTOLUENE	NS	--	--	NS	--	--	NS	--	--	NS	--	--
	SEC-BUTYLBENZENE	NS	--	--	NS	--	--	NS	--	--	NS	--	--
	TERT-BUTYLBENZENE	NS	--	--	NS	--	--	NS	--	--	NS	--	--
	TETRACHLOROETHENE	NS	--	--	NS	--	--	NS	--	--	NS	--	--
	TOLUENE	NS	--	--	NS	--	--	NS	--	--	NS	--	--
	TRANS-1,2-DICHLOROETHENE	NS	--	--	NS	--	--	NS	--	--	NS	--	--
	TRICHLOROETHENE	NS	--	--	NS	--	--	NS	--	--	NS	--	--
	TRICHLOROFUOROMETHANE	NS	--	--	NS	--	--	NS	--	--	NS	--	--
	VINYL CHLORIDE	NS	--	--	NS	--	--	NS	--	--	NS	--	--
	XYLENES	NS	--	--	NS	--	--	NS	--	--	NS	--	--

Refer to notes at the end of the table.

Table 12
Analytical Data Table for KAFB-106MW1-I

Phase Designation		Phase 1 Recirculation									Phase 1 Passive		
Sample ID		106MW1-P1R-102017			106MW1-P1R-102517			106MW1-P1R-110117			106MW1-P1P-111517		
Sample Date		10/20/2017			10/25/2017			11/1/2017			11/15/2017		
Sample Purpose		REG			REG			REG			REG		
Chemical Class and Analytical Method ^a	Parameter	Result	Val Qual	LOQ	Result	Val Qual	LOQ	Result	Val Qual	LOQ	Result	Val Qual	LOQ
Microbial Community (cells/mL) QuantArray-Chlor	1,1 DCA Reductase (DCA)	NS	--	--	NS	--	--	NS	--	--	NS	--	--
	1,2 DCA Reductase (DCAR)	NS	--	--	NS	--	--	NS	--	--	NS	--	--
	BAV1 Vinyl Chloride Reductase (BVC)	NS	--	--	NS	--	--	NS	--	--	NS	--	--
	cer A Reductase	NS	--	--	NS	--	--	NS	--	--	NS	--	--
	Chloroform Reductase (CFR)	NS	--	--	NS	--	--	NS	--	--	NS	--	--
	Dehalobacter DCM (DCM)	NS	--	--	NS	--	--	NS	--	--	NS	--	--
	Dehalobacter spp. (DHBt)	NS	--	--	NS	--	--	NS	--	--	NS	--	--
	Dehalobium chloro-coercia (DECO)	NS	--	--	NS	--	--	NS	--	--	NS	--	--
	Dehalococcoides (DHC)	NS	--	--	NS	--	--	NS	--	--	NS	--	--
	Dehalogenimonas spp. (DHG)	NS	--	--	NS	--	--	NS	--	--	NS	--	--
	Desulfotobacterium spp. (DSB)	NS	--	--	NS	--	--	NS	--	--	NS	--	--
	Desulfuromonas spp. (DSM)	NS	--	--	NS	--	--	NS	--	--	NS	--	--
	Dichloromethane Dehalogenase (DCMA)	NS	--	--	NS	--	--	NS	--	--	NS	--	--
	Epoxyalkane Transferase (EtnE)	NS	--	--	NS	--	--	NS	--	--	NS	--	--
	Ethene Monooxygenase (EtnC)	NS	--	--	NS	--	--	NS	--	--	NS	--	--
	Methanogens (MGN)	NS	--	--	NS	--	--	NS	--	--	NS	--	--
	PCE Reductase (PCE-1)	NS	--	--	NS	--	--	NS	--	--	NS	--	--
	Phenol Hydroxylase (PHE)	NS	--	--	NS	--	--	NS	--	--	NS	--	--
	PMMO	NS	--	--	NS	--	--	NS	--	--	NS	--	--
	Soluble Methane Monooxygenase (SMMO)	NS	--	--	NS	--	--	NS	--	--	NS	--	--
	Sulfate Reducing Bacteria (APS)	NS	--	--	NS	--	--	NS	--	--	NS	--	--
	tceA Reductase (TCE)	NS	--	--	NS	--	--	NS	--	--	NS	--	--
	Toluene Dioxygenase (TOD)	NS	--	--	NS	--	--	NS	--	--	NS	--	--
Toluene Monooxygenase (RMO)	NS	--	--	NS	--	--	NS	--	--	NS	--	--	
Toluene Monooxygenase 2 (RDEG)	NS	--	--	NS	--	--	NS	--	--	NS	--	--	
Total Eubacteria (EBAC)	NS	--	--	NS	--	--	NS	--	--	NS	--	--	
trans-1,2-DCE Reductase (TDR)	NS	--	--	NS	--	--	NS	--	--	NS	--	--	
Trichlorobenzene Dioxygenase (TCBO)	NS	--	--	NS	--	--	NS	--	--	NS	--	--	
Vinyl Chloride Reductase (VCR)	NS	--	--	NS	--	--	NS	--	--	NS	--	--	
EDB (µg/L) EPA Method 8011	1,2-DIBROMOETHANE	NS	--	--	6.28		1.88	NS	--	--	19.7		3.79
VFAs (mg/L) EPA Method 300m	ACETIC ACID	NS	--	--	ND	U	1	NS	--	--	1.62		1
	BUTYRIC ACID	NS	--	--	ND	U	1	NS	--	--	ND	U	1
	FORMIC ACID	NS	--	--	ND	U	1	NS	--	--	ND	U	1
	LACTIC ACID	NS	--	--	ND	U	1	NS	--	--	ND	U	1
	PROPIONIC ACID	NS	--	--	ND	U	1	NS	--	--	ND	U	1
	PYRUVIC ACID	NS	--	--	ND	U	1	NS	--	--	ND	U	1
VALERIC ACID	NS	--	--	ND	U	1	NS	--	--	ND	U	1	
Fluorometric (µg/L) Spectrofluorophotometry	FLUORESCCEIN	ND	U	0.01	26.642		0.01	50.107		0.01	16.293		0.01
Reduced Gases (µg/L) RSKSOP-175	ACETYLENE	NS	--	--	ND	U	10	NS	--	--	ND	U	10
	ETHANE	NS	--	--	ND	U	4	NS	--	--	ND	U	4
	ETHYLENE	NS	--	--	ND	U	5	NS	--	--	ND	U	5
	METHANE	NS	--	--	ND	U	2	NS	--	--	ND	U	2
	PROPANE	NS	--	--	ND	U	6	NS	--	--	ND	U	6
General Chemistry (mg/L) SM2320b, EPA Method 300, EPA Method 353.2, SM4500 Pec	ALKALINITY	NS	--	--	284		1	NS	--	--	188		1
	BROMIDE	NS	--	--	0.309		0.125	NS	--	--	0.591		0.125
	CHLORIDE	NS	--	--	27.8		0.33	NS	--	--	45.9		0.33
	IODIDE	NS	--	--	ND	U	0.75	NS	--	--	ND	U	0.75
	NITRATE	NS	--	--	NA	--	--	NS	--	--	NA	--	--
	NITRITE	NS	--	--	NA	--	--	NS	--	--	NA	--	--
	NITROGEN, NITRATE-NITRITE	NS	--	--	ND	U	0.375	NS	--	--	0.371	J	0.375
	O-PHOSPHATE (AS P)	NS	--	--	ND	U	0.02	NS	--	--	0.0116	J	0.02
	ORTHOPHOSPHATE	NS	--	--	NA	--	--	NS	--	--	NA	--	--
	PHOSPHORUS	NS	--	--	NA	--	--	NS	--	--	NA	--	--
SULFATE	NS	--	--	24.4		1	NS	--	--	17.1		1	

Table 12
Analytical Data Table for KAFB-106MW1-I

Phase Designation		Phase 1 Recirculation									Phase 1 Passive		
Sample ID		106MW1-P1R-102017			106MW1-P1R-102517			106MW1-P1R-110117			106MW1-P1P-111517		
Sample Date		10/20/2017			10/25/2017			11/1/2017			11/15/2017		
Sample Purpose		REG			REG			REG			REG		
Chemical Class and Analytical Method ^a	Parameter	Result	Val Qual	LOQ	Result	Val Qual	LOQ	Result	Val Qual	LOQ	Result	Val Qual	LOQ
Metals (mg/L) EPA Method 6010	LEAD	NS	--	--	NS	--	--	NS	--	--	NS	--	--
Dissolved Metals (mg/L) EPA Method 6010	IRON	NS	--	--	ND	U	0.06	NS	--	--	1.11		0.06
	MANGANESE	NS	--	--	0.26		0.006	NS	--	--	0.318		0.006
δ2H (‰) Mass Spectrometry, USGS Reston, VA	DELTA2H	-95.32		-99	-73.33		-99	-62.43		-99	-84.99		-99
VOCs (µg/L) EPA Method 8260	1,1,2-TRICHLOROETHANE	NS	--	--	ND	U	2.5	NS	--	--	ND	U	2.5
	1,2,4-TRICHLOROBENZENE	NS	--	--	NA	--	--	NS	--	--	NA	--	--
	1,2,4-TRIMETHYLBENZENE	NS	--	--	50.7		2.5	NS	--	--	31.3		2.5
	1,2-DIBROMOETHANE	NS	--	--	8.58		2.5	NS	--	--	27.4		2.5
	1,2-DICHLOROETHANE	NS	--	--	1.46	J	2.5	NS	--	--	1.98	J	2.5
	1,3,5-TRIMETHYLBENZENE	NS	--	--	18.4		2.5	NS	--	--	19		2.5
	2-BUTANONE	NS	--	--	28.3	J	25	NS	--	--	ND	U	25
	2-CHLOROTOLUENE	NS	--	--	ND	U	2.5	NS	--	--	ND	U	2.5
	2-HEXANONE	NS	--	--	27.9		12.5	NS	--	--	ND	U	12.5
	4-METHYL-2-PENTANONE	NS	--	--	24.8	J	12.5	NS	--	--	7.24	J	12.5
	ACETONE	NS	--	--	147		25	NS	--	--	43.3	J	25
	BENZENE	NS	--	--	371		2.5	NS	--	--	361		2.5
	CARBON DISULFIDE	NS	--	--	ND	U	2.5	NS	--	--	ND	U	2.5
	CHLOROMETHANE	NS	--	--	ND	U	2.5	NS	--	--	ND	U	2.5
	CIS-1,2-DICHLOROETHENE	NS	--	--	NA	--	--	NS	--	--	NA	--	--
	DICHLORODIFLUOROMETHANE	NS	--	--	ND	U	5	NS	--	--	ND	U	5
	ETHYLBENZENE	NS	--	--	97		2.5	NS	--	--	24.6		2.5
	ISOPROPYLBENZENE	NS	--	--	15.3		2.5	NS	--	--	8.93		2.5
	M,P-XYLENES	NS	--	--	NA	--	--	NS	--	--	NA	--	--
	METHYL TERT-BUTYL ETHER	NS	--	--	ND	U	2.5	NS	--	--	ND	U	2.5
	METHYLENE CHLORIDE	NS	--	--	ND	U	5	NS	--	--	ND	U	5
	NAPHTHALENE	NS	--	--	13.7		2.5	NS	--	--	10.4		2.5
	N-BUTYLBENZENE	NS	--	--	1.51	J	2.5	NS	--	--	1.52	J	2.5
	N-PROPYLBENZENE	NS	--	--	8.96		2.5	NS	--	--	1.72	J	2.5
	O-XYLENE	NS	--	--	NA	--	--	NS	--	--	NA	--	--
	P-ISOPROPYLTOLUENE	NS	--	--	2.14	J	2.5	NS	--	--	2.53	J	2.5
	SEC-BUTYLBENZENE	NS	--	--	1.78	J	2.5	NS	--	--	ND	U	2.5
	TERT-BUTYLBENZENE	NS	--	--	ND	U	2.5	NS	--	--	ND	U	2.5
	TETRACHLOROETHENE	NS	--	--	NA	--	--	NS	--	--	NA	--	--
	TOLUENE	NS	--	--	230		2.5	NS	--	--	117		2.5
	TRANS-1,2-DICHLOROETHENE	NS	--	--	NA	--	--	NS	--	--	NA	--	--
	TRICHLOROETHENE	NS	--	--	ND	U	2.5	NS	--	--	ND	U	2.5
	TRICHLOROFUOROMETHANE	NS	--	--	ND	U	5	NS	--	--	ND	U	5
	VINYL CHLORIDE	NS	--	--	NA	--	--	NS	--	--	NA	--	--
	XYLENES	NS	--	--	271		7.5	NS	--	--	266		7.5

Refer to notes at the end of the table.

**Table 12
Analytical Data Table for KAFB-106MW1-I**

Phase Designation		Phase 1 Passive			Phase 2 Recirculation			Phase 2 Recirculation			Phase 2 Recirculation		
Sample ID		106MW1-P1P-112817			106MW1-P2R-010918			106MW1-P2R-011618			106MW1-P2R-012418		
Sample Date		11/28/2017			1/9/2018			1/16/2018			1/24/2018		
Sample Purpose		REG			REG			REG			REG		
Chemical Class and Analytical Method ^a	Parameter	Result	Val Qual	LOQ	Result	Val Qual	LOQ	Result	Val Qual	LOQ	Result	Val Qual	LOQ
Microbial Community (cells/mL) QuantArray-Chlor	1,1 DCA Reductase (DCA)	ND	U	5.2	NS	--	--	NS	--	--	ND	U	4.9
	1,2 DCA Reductase (DCAR)	ND	U	5.2	NS	--	--	NS	--	--	ND	U	4.9
	BAV1 Vinyl Chloride Reductase (BVC)	ND	U	0.5	NS	--	--	NS	--	--	ND	U	0.5
	cer A Reductase	NA	--	--	NS	--	--	NS	--	--	ND	U	4.9
	Chloroform Reductase (CFR)	ND	U	5.2	NS	--	--	NS	--	--	ND	U	4.9
	Dehalobacter DCM (DCM)	ND	U	5.2	NS	--	--	NS	--	--	ND	U	4.9
	Dehalobacter spp. (DHBt)	1280		5.2	NS	--	--	NS	--	--	219000		4.9
	Dehalobium chlorocoercia (DECO)	ND	U	5.2	NS	--	--	NS	--	--	6200		4.9
	Dehalococcoides (DHC)	ND	U	0.5	NS	--	--	NS	--	--	ND	U	0.5
	Dehalogenimonas spp. (DHG)	ND	U	5.2	NS	--	--	NS	--	--	ND	U	4.9
	Desulfotobacterium spp. (DSB)	3190		5.2	NS	--	--	NS	--	--	107000		4.9
	Desulfuromonas spp. (DSM)	73.5		5.2	NS	--	--	NS	--	--	69.2		4.9
	Dichloromethane Dehalogenase (DCMA)	ND	U	5.2	NS	--	--	NS	--	--	ND	U	4.9
	Epoxyalkane Transferase (EtnE)	ND	U	5.2	NS	--	--	NS	--	--	160		4.9
	Ethene Monooxygenase (EtnC)	ND	U	5.2	NS	--	--	NS	--	--	ND	U	4.9
	Methanogens (MGN)	0.3	J	5.2	NS	--	--	NS	--	--	4.4	J	4.9
	PCE Reductase (PCE-1)	NA	--	--	NS	--	--	NS	--	--	ND	U	4.9
	Phenol Hydroxylase (PHE)	1740		5.2	NS	--	--	NS	--	--	55300		4.9
	PMMO	ND	U	5.2	NS	--	--	NS	--	--	NA	--	--
	Soluble Methane Monooxygenase (SMMO)	ND	U	5.2	NS	--	--	NS	--	--	1170		4.9
	Sulfate Reducing Bacteria (APS)	19600		5.2	NS	--	--	NS	--	--	80200		4.9
	tceA Reductase (TCE)	ND	U	0.5	NS	--	--	NS	--	--	ND	U	0.5
	Toluene Dioxygenase (TOD)	2290		5.2	NS	--	--	NS	--	--	8450		4.9
	Toluene Monooxygenase (RMO)	2400		5.2	NS	--	--	NS	--	--	127000		4.9
	Toluene Monooxygenase 2 (RDEG)	590		5.2	NS	--	--	NS	--	--	35900		4.9
	Total Eubacteria (EBAC)	284000		5.2	NS	--	--	NS	--	--	3820000		4.9
	trans-1,2-DCE Reductase (TDR)	NA	--	--	NS	--	--	NS	--	--	ND	U	4.9
Trichlorobenzene Dioxygenase (TCBO)	427		5.2	NS	--	--	NS	--	--	531		4.9	
Vinyl Chloride Reductase (VCR)	ND	U	0.5	NS	--	--	NS	--	--	ND	U	0.5	
EDB (µg/L) EPA Method 8011	1,2-DIBROMOETHANE	0.302		0.0189	43.4		1.91	49.6		1.89	44.2		1.89
VFAs (mg/L) EPA Method 300m	ACETIC ACID	1.31		1	0.39	J	1	ND	U	1	0.98	J	1
	BUTYRIC ACID	ND	U	1	ND	U	1	ND	U	1	ND	U	1
	FORMIC ACID	ND	U	1	ND	U	1	ND	U	1	ND	U	1
	LACTIC ACID	ND	U	1	1.59		1	0.69	J	1	0.97	J	1
	PROPIONIC ACID	ND	U	1	ND	U	1	ND	U	1	0.67	J	1
	PYRUVIC ACID	ND	U	1	ND	U	1	ND	U	1	ND	U	1
VALERIC ACID	ND	U	1	ND	U	1	ND	U	1	ND	U	1	
Fluorometric (µg/L) Spectrofluorophotometry	FLUORESCCEIN	0.064		0.01	NS	--	--	NS	--	--	NS	--	--
Reduced Gases (µg/L) RSKSOP-175	ACETYLENE	ND	U	10	ND	U	10	ND	U	10	ND	U	10
	ETHANE	ND	U	4	ND	U	4	ND	U	4	0.75	J	4
	ETHYLENE	ND	U	5	2.1	J	5	2.9	J	5	3.55	J	5
	METHANE	ND	U	2	1.14	J	2	ND	U	2	1.31	J	2
	PROPANE	ND	U	6	ND	U	6	ND	U	6	ND	U	6
General Chemistry (mg/L) SM2320b, EPA Method 300, EPA Method 353.2, SM4500 Pec	ALKALINITY	164		1	325		1	358		1	366		1
	BROMIDE	0.779		0.125	0.547		0.25	0.636		0.25	0.529	J-	0.25
	CHLORIDE	50.1		0.33	47.5		0.66	54.2		0.66	48.5		0.66
	IODIDE	ND	U	0.75	ND	U	0.75	ND	U	0.75	0.56	J	0.75
	NITRATE	NA	--	--	NA	--	--	NA	--	--	NA	--	--
	NITRITE	NA	--	--	NA	--	--	NA	--	--	NA	--	--
	NITROGEN, NITRATE-NITRITE	ND	U	0.375	ND	U	0.375	ND	U	0.375	ND	U	0.375
	O-PHOSPHATE (AS P)	ND	U	0.02	ND	U	0.02	ND	U	0.02	ND	U	0.02
	ORTHOPHOSPHATE	NA	--	--	NA	--	--	NA	--	--	NA	--	--
	PHOSPHORUS	NA	--	--	NA	--	--	NA	--	--	NA	--	--
SULFATE	11.7		1	7.22		2	4.61	J	2	1.73	J	2	

Table 12
Analytical Data Table for KAFB-106MW1-I

Phase Designation		Phase 1 Passive			Phase 2 Recirculation								
Sample ID		106MW1-P1P-112817			106MW1-P2R-010918			106MW1-P2R-011618			106MW1-P2R-012418		
Sample Date		11/28/2017			1/9/2018			1/16/2018			1/24/2018		
Sample Purpose		REG			REG			REG			REG		
Chemical Class and Analytical Method ^a	Parameter	Result	Val Qual	LOQ	Result	Val Qual	LOQ	Result	Val Qual	LOQ	Result	Val Qual	LOQ
Metals (mg/L) EPA Method 6010	LEAD	NS	--	--	NS	--	--	NS	--	--	NS	--	--
Dissolved Metals (mg/L) EPA Method 6010	IRON	ND	U	0.06	1.39		0.06	5.68		0.06	6.41	J-	0.06
	MANGANESE	0.0213		0.006	3.29		0.006	0.968		0.006	1.09	J-	0.006
δ2H (‰) Mass Spectrometry, USGS Reston, VA	DELTA2H	-95.69		-99	NS	--	--	NS	--	--	NS	--	--
VOCs (µg/L) EPA Method 8260	1,1,2-TRICHLOROETHANE	ND	U	1	ND	U	12.5	ND	U	25	ND	U	25
	1,2,4-TRICHLOROBENZENE	NA	--	--	NA	--	--	NA	--	--	NA	--	--
	1,2,4-TRIMETHYLBENZENE	0.631	J	1	131		12.5	140		25	195		25
	1,2-DIBROMOETHANE	ND	U	1	32.5		12.5	34	J	25	30.7	J	25
	1,2-DICHLOROETHANE	3.43		1	ND	U	12.5	ND	U	25	ND	U	25
	1,3,5-TRIMETHYLBENZENE	1.31	J	1	81.8		12.5	79.1		25	98.1		25
	2-BUTANONE	ND	U	10	ND	U	125	ND	U	250	ND	U	250
	2-CHLOROTOLUENE	ND	U	1	ND	U	12.5	ND	U	25	ND	U	25
	2-HEXANONE	ND	U	5	ND	U	62.5	ND	U	125	ND	U	125
	4-METHYL-2-PENTANONE	ND	U	5	33.8	J	62.5	ND	U	125	ND	U	125
	ACETONE	13.7	J	10	157	J	125	195	J	250	193	J	250
	BENZENE	0.635	J	1	1200		12.5	1380		25	1570		25
	CARBON DISULFIDE	ND	U	1	ND	U	12.5	ND	U	25	ND	U	25
	CHLOROMETHANE	ND	U	1	ND	U	12.5	ND	U	25	ND	U	25
	CIS-1,2-DICHLOROETHENE	NA	--	--	NA	--	--	NA	--	--	NA	--	--
	DICHLORODIFLUOROMETHANE	ND	U	2	ND	U	25	ND	U	50	ND	U	50
	ETHYLBENZENE	ND	U	1	449		12.5	537		25	614		25
	ISOPROPYLBENZENE	2.07		1	36.6		12.5	41.4	J	25	51		25
	M,P-XYLENES	NA	--	--	NA	--	--	NA	--	--	NA	--	--
	METHYL TERT-BUTYL ETHER	1.82	J	1	ND	U	12.5	ND	U	25	ND	U	25
	METHYLENE CHLORIDE	ND	U	2	ND	U	25	ND	U	50	ND	U	50
	NAPHTHALENE	ND	U	1	43.8		12.5	40.1	J	25	55.6		25
	N-BUTYLBENZENE	ND	U	1	8.08	J	12.5	ND	U	25	ND	U	25
	N-PROPYLBENZENE	ND	U	1	35.5		12.5	34.2	J	25	44.3	J	25
	O-XYLENE	NA	--	--	NA	--	--	NA	--	--	NA	--	--
	P-ISOPROPYLTOLUENE	ND	U	1	25	J	12.5	25.5	J	25	ND	U	25
	SEC-BUTYLBENZENE	ND	U	1	6.56	J	12.5	ND	U	25	ND	U	25
	TERT-BUTYLBENZENE	ND	U	1	ND	U	12.5	ND	U	25	ND	U	25
	TETRACHLOROETHENE	NA	--	--	NA	--	--	NA	--	--	NA	--	--
	TOLUENE	0.918	J	1	2530		12.5	3930		25	5000		25
	TRANS-1,2-DICHLOROETHENE	NA	--	--	NA	--	--	NA	--	--	NA	--	--
	TRICHLOROETHENE	ND	U	1	ND	U	12.5	ND	U	25	ND	U	25
	TRICHLOROFUOROMETHANE	ND	U	2	ND	U	25	ND	U	50	ND	U	50
	VINYL CHLORIDE	NA	--	--	NA	--	--	NA	--	--	NA	--	--
	XYLENES	4.89	J	3	1190		37.5	1510		75	1770		75

Refer to notes at the end of the table.

Table 12
Analytical Data Table for KAFB-106MW1-I

Phase Designation		Phase 2 Recirculation						Phase 2 Passive					
Sample ID		106MW1-P2R-012418-FD						106MW1-P2P-030618					
Sample Date		1/24/2018						3/6/2018					
Sample Purpose		FD						REG					
Chemical Class and Analytical Method ^a	Parameter	FD			REG			REG			REG		
		Result	Val Qual	LOQ	Result	Val Qual	LOQ	Result	Val Qual	LOQ	Result	Val Qual	LOQ
Microbial Community (cells/mL) QuantArray-Chlor	1,1 DCA Reductase (DCA)	NS	--	--	NS	--	--	NS	--	--	ND	U	4.8
	1,2 DCA Reductase (DCAR)	NS	--	--	NS	--	--	NS	--	--	ND	U	4.8
	BAV1 Vinyl Chloride Reductase (BVC)	NS	--	--	NS	--	--	NS	--	--	ND	U	0.5
	cer A Reductase	NS	--	--	NS	--	--	NS	--	--	ND	U	4.8
	Chloroform Reductase (CFR)	NS	--	--	NS	--	--	NS	--	--	ND	U	4.8
	Dehalobacter DCM (DCM)	NS	--	--	NS	--	--	NS	--	--	1620		4.8
	Dehalobacter spp. (DHBt)	NS	--	--	NS	--	--	NS	--	--	103000		4.8
	Dehalobium chloro-coercia (DECO)	NS	--	--	NS	--	--	NS	--	--	11700		4.8
	Dehalococcoides (DHC)	NS	--	--	NS	--	--	NS	--	--	ND	U	0.5
	Dehalogenimonas spp. (DHG)	NS	--	--	NS	--	--	NS	--	--	ND	U	4.8
	Desulfotobacterium spp. (DSB)	NS	--	--	NS	--	--	NS	--	--	35300		4.8
	Desulfuromonas spp. (DSM)	NS	--	--	NS	--	--	NS	--	--	9.4		4.8
	Dichloromethane Dehalogenase (DCMA)	NS	--	--	NS	--	--	NS	--	--	ND	U	4.8
	Epoxyalkane Transferase (EtnE)	NS	--	--	NS	--	--	NS	--	--	ND	U	4.8
	Ethene Monooxygenase (EtnC)	NS	--	--	NS	--	--	NS	--	--	ND	U	4.8
	Methanogens (MGN)	NS	--	--	NS	--	--	NS	--	--	13.6		4.8
	PCE Reductase (PCE-1)	NS	--	--	NS	--	--	NS	--	--	ND	U	4.8
	Phenol Hydroxylase (PHE)	NS	--	--	NS	--	--	NS	--	--	15300		4.8
	PMMO	NS	--	--	NS	--	--	NS	--	--	NA	--	--
	Soluble Methane Monooxygenase (SMMO)	NS	--	--	NS	--	--	NS	--	--	ND	U	4.8
	Sulfate Reducing Bacteria (APS)	NS	--	--	NS	--	--	NS	--	--	82200		4.8
	tceA Reductase (TCE)	NS	--	--	NS	--	--	NS	--	--	ND	U	0.5
	Toluene Dioxygenase (TOD)	NS	--	--	NS	--	--	NS	--	--	ND	U	4.8
	Toluene Monooxygenase (RMO)	NS	--	--	NS	--	--	NS	--	--	19600		4.8
	Toluene Monooxygenase 2 (RDEG)	NS	--	--	NS	--	--	NS	--	--	8320		4.8
	Total Eubacteria (EBAC)	NS	--	--	NS	--	--	NS	--	--	4040000		4.8
trans-1,2-DCE Reductase (TDR)	NS	--	--	NS	--	--	NS	--	--	ND	U	4.8	
Trichlorobenzene Dioxygenase (TCBO)	NS	--	--	NS	--	--	NS	--	--	385		4.8	
Vinyl Chloride Reductase (VCR)	NS	--	--	NS	--	--	NS	--	--	ND	U	0.5	
EDB (µg/L) EPA Method 8011	1,2-DIBROMOETHANE	32.1		1.9	22.9	J+	1.91	16.2	J	1.9	7.7		0.379
VFAs (mg/L) EPA Method 300m	ACETIC ACID	0.39	J	1	3.31		1	1.15		1	0.8	J	1
	BUTYRIC ACID	ND	U	1	ND	U	1	ND	U	1	ND	U	1
	FORMIC ACID	ND	U	1	ND	U	1	ND	U	1	ND	U	1
	LACTIC ACID	0.39	J	1	1.15		1	0.79	J	1	0.79	J	1
	PROPIONIC ACID	ND	U	1	ND	U	1	ND	U	1	ND	U	1
	PYRUVIC ACID	ND	U	1	ND	U	1	ND	U	1	ND	U	1
	VALERIC ACID	ND	U	1	ND	U	1	ND	U	1	ND	U	1
Fluorometric (µg/L) Spectrofluorophotometry	FLUORESC EIN	NS	--	--	NS	--	--	NS	--	--	NS	--	--
Reduced Gases (µg/L) RSKSOP-175	ACETYLENE	ND	U	10	ND	U	10	ND	U	10	ND	U	10
	ETHANE	0.78	J	4	0.9	J	4	1.24	J	4	1	J	4
	ETHYLENE	4.05	J	5	3.01	J	5	2.6		5	1.26	J	5
	METHANE	1.35	J	2	1.4	J	2	1.58		2	1.2	J	2
	PROPANE	ND	U	6	ND	U	6	ND	U	6	1.2	J	6
General Chemistry (mg/L) SM2320b, EPA Method 300, EPA Method 353.2, SM4500 Pec	ALKALINITY	360		1	389		1	267		1	320	J-	1
	BROMIDE	0.548		0.25	0.568		0.25	0.564		0.25	0.576	J-	0.25
	CHLORIDE	48.9		0.66	49.9		0.66	50.3		0.66	50.8		0.66
	IODIDE	0.58	J	0.75	1.2		0.75	ND	U	0.75	ND	U	0.75
	NITRATE	NA	--	--	NA	--	--	ND	U	0.2	ND	U	0.2
	NITRITE	NA	--	--	NA	--	--	ND	U	0.2	ND	U	0.2
	NITROGEN, NITRATE-NITRITE	ND	U	0.375	ND	U	0.375	NA	--	--	NA	--	--
	O-PHOSPHATE (AS P)	ND	U	0.02	ND	U	0.02	0.0436		0.02	0.0167	J	0.02
	ORTHOPHOSPHATE	NA	--	--	NA	--	--	NA	--	--	NA	--	--
	PHOSPHORUS	NA	--	--	NA	--	--	NA	--	--	NA	--	--
	SULFATE	1.75	J	2	1.2	J	2	1.23	J	2	ND	U	2

Table 12
Analytical Data Table for KAFB-106MW1-I

Phase Designation		Phase 2 Recirculation			Phase 2 Passive								
Sample ID		106MW1-P2R-012418-FD			106MW1-P2P-030618			106MW1-P2P-041018			106MW1-P2P-050818		
Sample Date		1/24/2018			3/6/2018			4/10/2018			5/8/2018		
Sample Purpose		FD			REG			REG			REG		
Chemical Class and Analytical Method ^a	Parameter	Result	Val Qual	LOQ	Result	Val Qual	LOQ	Result	Val Qual	LOQ	Result	Val Qual	LOQ
Metals (mg/L) EPA Method 6010	LEAD	NS	--	--	NS	--	--	NS	--	--	NS	--	--
Dissolved Metals (mg/L) EPA Method 6010	IRON	6.51	J-	0.06	15.2		0.06	9.99	J-	0.06	11		0.06
	MANGANESE	1.05	J-	0.006	2.23		0.006	2.37	J+	0.006	2.65		0.006
δ2H (‰) Mass Spectrometry, USGS Reston, VA	DELTA2H	NS	--	--	NS	--	--	NS	--	--	NS	--	--
VOCs (µg/L) EPA Method 8260	1,1,2-TRICHLOROETHANE	ND	U	25	ND	U	25	ND	U	1	ND	U	2.5
	1,2,4-TRICHLOROBENZENE	NA	--	--	NA	--	--	NA	--	--	NA	--	--
	1,2,4-TRIMETHYLBENZENE	200		25	85.3		25	25.3		1	11.8		2.5
	1,2-DIBROMOETHANE	31.1	J	25	16.9	J	25	9.78		1	9.48		2.5
	1,2-DICHLOROETHANE	ND	U	25	ND	U	25	2.77		1	2.36	J	2.5
	1,3,5-TRIMETHYLBENZENE	100		25	51.8		25	26.8		1	19.9		2.5
	2-BUTANONE	ND	U	250	ND	U	250	8.17	J	10	ND	U	25
	2-CHLOROTOLUENE	ND	U	25	ND	U	25	ND	U	1	ND	U	2.5
	2-HEXANONE	ND	U	125	ND	U	125	ND	U	5	ND	U	12.5
	4-METHYL-2-PENTANONE	ND	U	125	ND	U	125	5.06	J	5	ND	U	12.5
	ACETONE	196	J	250	ND	U	250	38.9		10	33.6	J	25
	BENZENE	1660		25	573		25	97.7		1	54.7		2.5
	CARBON DISULFIDE	ND	U	25	ND	U	25	ND	U	1	ND	U	2.5
	CHLOROMETHANE	ND	U	25	ND	U	25	ND	U	1	ND	U	2.5
	CIS-1,2-DICHLOROETHENE	NA	--	--	NA	--	--	NA	--	--	NA	--	--
	DICHLORODIFLUOROMETHANE	ND	U	50	ND	U	50	ND	U	2	ND	U	5
	ETHYLBENZENE	634		25	321		25	28.4		1	8.56		2.5
	ISOPROPYLBENZENE	49.5	J	25	33.4	J	25	31.2		1	36.3		2.5
	M,P-XYLENES	NA	--	--	NA	--	--	NA	--	--	NA	--	--
	METHYL TERT-BUTYL ETHER	ND	U	25	ND	U	25	ND	U	1	ND	U	2.5
	METHYLENE CHLORIDE	ND	U	50	ND	U	50	ND	U	2	ND	U	5
	NAPHTHALENE	50.6		25	26.3	J	25	8.31		1	3.02	J	2.5
	N-BUTYLBENZENE	ND	U	25	ND	U	25	ND	U	1	ND	U	2.5
	N-PROPYLBENZENE	46	J	25	23	J	25	2.57		1	ND	U	2.5
	O-XYLENE	NA	--	--	NA	--	--	NA	--	--	NA	--	--
	P-ISOPROPYLTOLUENE	ND	U	25	125		25	134		1	153		2.5
	SEC-BUTYLBENZENE	ND	U	25	ND	U	25	0.761	J	1	ND	U	2.5
	TERT-BUTYLBENZENE	ND	U	25	ND	U	25	ND	U	1	ND	U	2.5
	TETRACHLOROETHENE	NA	--	--	NA	--	--	NA	--	--	NA	--	--
	TOLUENE	5090		25	2640		25	89		1	19.6		2.5
	TRANS-1,2-DICHLOROETHENE	NA	--	--	NA	--	--	NA	--	--	NA	--	--
	TRICHLOROETHENE	ND	U	25	ND	U	25	ND	U	1	ND	U	2.5
	TRICHLOROFLUOROMETHANE	ND	U	50	ND	U	50	ND	U	2	ND	U	5
	VINYL CHLORIDE	NA	--	--	NA	--	--	NA	--	--	NA	--	--
	XYLENES	1780		75	955		75	260		3	182		7.5

Refer to notes at the end of the table.

Table 12
Analytical Data Table for KAFB-106MW1-I

Phase Designation		Phase 2 Passive			Phase 3 Recirculation			Phase 3 Recirculation			Phase 3 Recirculation		
Sample ID		106MW1-P2P-061218			106MW1-P3R-080718			106MW1-P3R-081518			106MW1-P3R-082118		
Sample Date		6/12/2018			8/7/2018			8/15/2018			8/21/2018		
Sample Purpose		REG			REG			REG			REG		
Chemical Class and Analytical Method ^a	Parameter	Result	Val Qual	LOQ	Result	Val Qual	LOQ	Result	Val Qual	LOQ	Result	Val Qual	LOQ
Microbial Community (cells/mL) QuantArray-Chlor	1,1 DCA Reductase (DCA)	NS	--	--	NS	--	--	NS	--	--	ND	U	5
	1,2 DCA Reductase (DCAR)	NS	--	--	NS	--	--	NS	--	--	ND	U	5
	BAV1 Vinyl Chloride Reductase (BVC)	NS	--	--	NS	--	--	NS	--	--	ND	U	0.5
	cer A Reductase	NS	--	--	NS	--	--	NS	--	--	ND	U	5
	Chloroform Reductase (CFR)	NS	--	--	NS	--	--	NS	--	--	ND	U	5
	Dehalobacter DCM (DCM)	NS	--	--	NS	--	--	NS	--	--	539		5
	Dehalobacter spp. (DHBt)	NS	--	--	NS	--	--	NS	--	--	151000		5
	Dehalobium chlorocoercia (DECO)	NS	--	--	NS	--	--	NS	--	--	12100		5
	Dehalococcoides (DHC)	NS	--	--	NS	--	--	NS	--	--	ND	U	0.5
	Dehalogenimonas spp. (DHG)	NS	--	--	NS	--	--	NS	--	--	ND	U	5
	Desulfotobacterium spp. (DSB)	NS	--	--	NS	--	--	NS	--	--	105000		5
	Desulfuromonas spp. (DSM)	NS	--	--	NS	--	--	NS	--	--	18.8		5
	Dichloromethane Dehalogenase (DCMA)	NS	--	--	NS	--	--	NS	--	--	ND	U	5
	Epoxyalkane Transferase (EtnE)	NS	--	--	NS	--	--	NS	--	--	183		5
	Ethene Monooxygenase (EtnC)	NS	--	--	NS	--	--	NS	--	--	ND	U	5
	Methanogens (MGN)	NS	--	--	NS	--	--	NS	--	--	151		5
	PCE Reductase (PCE-1)	NS	--	--	NS	--	--	NS	--	--	ND	U	5
	Phenol Hydroxylase (PHE)	NS	--	--	NS	--	--	NS	--	--	2080		5
	PMMO	NS	--	--	NS	--	--	NS	--	--	NA	--	--
	Soluble Methane Monooxygenase (SMMO)	NS	--	--	NS	--	--	NS	--	--	187		5
	Sulfate Reducing Bacteria (APS)	NS	--	--	NS	--	--	NS	--	--	148000		5
tceA Reductase (TCE)	NS	--	--	NS	--	--	NS	--	--	ND	U	0.5	
Toluene Dioxygenase (TOD)	NS	--	--	NS	--	--	NS	--	--	ND	U	5	
Toluene Monooxygenase (RMO)	NS	--	--	NS	--	--	NS	--	--	69200		5	
Toluene Monooxygenase 2 (RDEG)	NS	--	--	NS	--	--	NS	--	--	4550		5	
Total Eubacteria (EBAC)	NS	--	--	NS	--	--	NS	--	--	13600000		5	
trans-1,2-DCE Reductase (TDR)	NS	--	--	NS	--	--	NS	--	--	ND	U	5	
Trichlorobenzene Dioxygenase (TCBO)	NS	--	--	NS	--	--	NS	--	--	ND	U	5	
Vinyl Chloride Reductase (VCR)	NS	--	--	NS	--	--	NS	--	--	ND	U	0.5	
EDB (µg/L) EPA Method 8011	1,2-DIBROMOETHANE	4.5		0.192	NS	--	--	2.3		0.006	2.7		0.03
VFAs (mg/L) EPA Method 300m	ACETIC ACID	3		1	14.4		1	27.7		1	40.7		10
	BUTYRIC ACID	ND	U	1	ND	U	1	ND	U	1	ND	U	1
	FORMIC ACID	ND	U	1	4.5	J	10	ND	U	1	0.9	J	10
	LACTIC ACID	0.8	J	1	0.3	J	1	0.6	J	1	0.7	J	1
	PROPIONIC ACID	ND	U	1	ND	U	1	ND	U	1	ND	U	1
	PYRUVIC ACID	ND	U	1	ND	U	1	ND	U	1	ND	U	1
Fluorometric (µg/L) Spectrofluorophotometry	VALERIC ACID	ND	U	1	ND	U	1	ND	U	1	ND	U	1
	FLUORESCCEIN	NS	--	--	NS	--	--	NS	--	--	NS	--	--
Reduced Gases (µg/L) RSKSOP-175	ACETYLENE	ND	U	10	ND	U	10	ND	U	10	ND	U	10
	ETHANE	1.2	J	4	1.1	J	4	1	J	4	1.1	J	4
	ETHYLENE	2.3	J	5	2.1	J	5	3.8	J	5	3.7	J	5
	METHANE	7.4		2	18.5		2	16.6		2	13.9		2
	PROPANE	1.8	J	6	1.2	J	6	1.1	J	6	1.3	J	6
General Chemistry (mg/L) SM2320b, EPA Method 300, EPA Method 353.2, SM4500 Pec	ALKALINITY	348		1	NA	--	--	360		5	400		5
	BROMIDE	0.619		0.25	NA	--	--	0.85		0.5	0.81		0.5
	CHLORIDE	56.8		0.66	NA	--	--	49		0.5	49		0.5
	IODIDE	0.62	J	0.75	10		0.75	12		0.75	13		0.75
	NITRATE	ND	U	0.2	NA	--	--	NA	--	--	NA	--	--
	NITRITE	ND	U	0.2	NA	--	--	NA	--	--	NA	--	--
	NITROGEN, NITRATE-NITRITE	NA	--	--	NA	--	--	ND	U	0.05	ND		0.05
	O-PHOSPHATE (AS P)	0.0418		0.02	NA	--	--	NA	--	--	NA	--	--
	ORTHOPHOSPHATE	NA	--	--	NA	--	--	ND	U	0.15	ND		0.15
	PHOSPHORUS	NA	--	--	NA	--	--	NA	--	--	NA	--	--
SULFATE	ND	U	2	NA	--	--	ND	U	1	1.9		1	

Table 12
Analytical Data Table for KAFB-106MW1-I

Phase Designation		Phase 2 Passive			Phase 3 Recirculation								
Sample ID		106MW11-P2P-061218			106MW11-P3R-080718			106MW11-P3R-081518			106MW11-P3R-082118		
Sample Date		6/12/2018			8/7/2018			8/15/2018			8/21/2018		
Sample Purpose		REG			REG			REG			REG		
Chemical Class and Analytical Method ^a	Parameter	Result	Val Qual	LOQ	Result	Val Qual	LOQ	Result	Val Qual	LOQ	Result	Val Qual	LOQ
Metals (mg/L) EPA Method 6010	LEAD	NS	--	--	NS	--	--	NS	--	--	NS	--	--
Dissolved Metals (mg/L) EPA Method 6010	IRON	12.9		0.06	NA	--	--	7.3		0.05	6.9		0.05
	MANGANESE	3.87		0.006	NA	--	--	4.3		0.003	4.2		0.003
δ2H (‰) Mass Spectrometry, USGS Reston, VA	DELTA2H	NS	--	--	NS	--	--	NS	--	--	NS	--	--
VOCs (µg/L) EPA Method 8260	1,1,2-TRICHLOROETHANE	ND	U	1	NA	--	--	ND	U	50	ND	U	2.5
	1,2,4-TRICHLOROBENZENE	NA	--	--	NA	--	--	NA	--	--	NA	--	--
	1,2,4-TRIMETHYLBENZENE	41.3		1	NA	--	--	710		100	350		5
	1,2-DIBROMOETHANE	7.18		1	NA	--	--	ND	U	100	3.9	J	5
	1,2-DICHLOROETHANE	2.97		1	NA	--	--	ND	U	100	ND	U	5
	1,3,5-TRIMETHYLBENZENE	28.1		1	NA	--	--	240		50	110		2.5
	2-BUTANONE	6.42	J	10	NA	--	--	ND	U	1000	44	J	50
	2-CHLOROTOLUENE	ND	U	1	NA	--	--	ND	U	50	ND	U	2.5
	2-HEXANONE	ND	U	5	NA	--	--	ND	U	500	90		25
	4-METHYL-2-PENTANONE	4.1	J	5	NA	--	--	ND	U	500	73		25
	ACETONE	25.4		10	NA	--	--	ND	U	1000	190		50
	BENZENE	128		1	NA	--	--	3500		100	2800		50
	CARBON DISULFIDE	ND	U	1	NA	--	--	ND	U	200	ND	U	10
	CHLOROMETHANE	ND	U	1	NA	--	--	ND	U	100	ND	U	5
	CIS-1,2-DICHLOROETHENE	NA	--	--	NA	--	--	NA	--	--	NA	--	--
	DICHLORODIFLUOROMETHANE	ND	U	2	NA	--	--	ND	U	100	ND	U	5
	ETHYLBENZENE	91.3		1	NA	--	--	1800		100	980		5
	ISOPROPYLBENZENE	64.4		1	NA	--	--	200		100	120		5
	M,P-XYLENES	NA	--	--	NA	--	--	NA	--	--	NA	--	--
	METHYL TERT-BUTYL ETHER	0.631	J	1	NA	--	--	ND	U	50	ND	U	2.5
	METHYLENE CHLORIDE	ND	U	2	NA	--	--	ND	U	500	ND	U	25
	NAPHTHALENE	11.3		1	NA	--	--	820		500	140		25
	N-BUTYLBENZENE	ND	U	1	NA	--	--	51	J	100	14		5
	N-PROPYLBENZENE	11.3		1	NA	--	--	200		100	110		5
	O-XYLENE	NA	--	--	NA	--	--	NA	--	--	NA	--	--
	P-ISOPROPYLTOLUENE	138		1	NA	--	--	160		100	41		5
	SEC-BUTYLBENZENE	2.49		1	NA	--	--	ND	U	100	14		5
	TERT-BUTYLBENZENE	ND	U	1	NA	--	--	ND	U	100	ND	U	5
	TETRACHLOROETHENE	NA	--	--	NA	--	--	NA	--	--	NA	--	--
	TOLUENE	109		1	NA	--	--	8000		100	4900		50
	TRANS-1,2-DICHLOROETHENE	NA	--	--	NA	--	--	NA	--	--	NA	--	--
	TRICHLOROETHENE	ND	U	1	NA	--	--	ND	U	100	ND	U	5
	TRICHLOROFLUOROMETHANE	ND	U	2	NA	--	--	ND	U	100	ND	U	5
	VINYL CHLORIDE	NA	--	--	NA	--	--	NA	--	--	NA	--	--
	XYLENES	293		3	NA	--	--	5100		50	3100		25

Refer to notes at the end of the table.

Table 12
Analytical Data Table for KAFB-106MW1-I

Phase Designation		Phase 3 Recirculation						Phase 3 Passive					
Sample ID		106MW1-P3R-082118-FD			106MW1-P3R-082818			106MW1-P3P-091118			106MW1-P3P-100318		
Sample Date		8/21/2018			8/28/2018			9/11/2018			10/3/2018		
Sample Purpose		FD			REG			REG			REG		
Chemical Class and Analytical Method ^a	Parameter	Result	Val Qual	LOQ	Result	Val Qual	LOQ	Result	Val Qual	LOQ	Result	Val Qual	LOQ
Microbial Community (cells/mL) QuantArray-Chlor	1,1 DCA Reductase (DCA)	NS	--	--	NS	--	--	NS	--	--	NS	--	--
	1,2 DCA Reductase (DCAR)	NS	--	--	NS	--	--	NS	--	--	NS	--	--
	BAV1 Vinyl Chloride Reductase (BVC)	NS	--	--	NS	--	--	NS	--	--	NS	--	--
	cer A Reductase	NS	--	--	NS	--	--	NS	--	--	NS	--	--
	Chloroform Reductase (CFR)	NS	--	--	NS	--	--	NS	--	--	NS	--	--
	Dehalobacter DCM (DCM)	NS	--	--	NS	--	--	NS	--	--	NS	--	--
	Dehalobacter spp. (DHBt)	NS	--	--	NS	--	--	NS	--	--	NS	--	--
	Dehalobium chlorocoercia (DECO)	NS	--	--	NS	--	--	NS	--	--	NS	--	--
	Dehalococcoides (DHC)	NS	--	--	NS	--	--	NS	--	--	NS	--	--
	Dehalogenimonas spp. (DHG)	NS	--	--	NS	--	--	NS	--	--	NS	--	--
	Desulfotobacterium spp. (DSB)	NS	--	--	NS	--	--	NS	--	--	NS	--	--
	Desulfuromonas spp. (DSM)	NS	--	--	NS	--	--	NS	--	--	NS	--	--
	Dichloromethane Dehalogenase (DCMA)	NS	--	--	NS	--	--	NS	--	--	NS	--	--
	Epoxyalkane Transferase (EtnE)	NS	--	--	NS	--	--	NS	--	--	NS	--	--
	Ethene Monooxygenase (EtnC)	NS	--	--	NS	--	--	NS	--	--	NS	--	--
	Methanogens (MGN)	NS	--	--	NS	--	--	NS	--	--	NS	--	--
	PCE Reductase (PCE-1)	NS	--	--	NS	--	--	NS	--	--	NS	--	--
	Phenol Hydroxylase (PHE)	NS	--	--	NS	--	--	NS	--	--	NS	--	--
	PMMO	NS	--	--	NS	--	--	NS	--	--	NS	--	--
	Soluble Methane Monooxygenase (SMMO)	NS	--	--	NS	--	--	NS	--	--	NS	--	--
	Sulfate Reducing Bacteria (APS)	NS	--	--	NS	--	--	NS	--	--	NS	--	--
	tceA Reductase (TCE)	NS	--	--	NS	--	--	NS	--	--	NS	--	--
	Toluene Dioxygenase (TOD)	NS	--	--	NS	--	--	NS	--	--	NS	--	--
Toluene Monooxygenase (RMO)	NS	--	--	NS	--	--	NS	--	--	NS	--	--	
Toluene Monooxygenase 2 (RDEG)	NS	--	--	NS	--	--	NS	--	--	NS	--	--	
Total Eubacteria (EBAC)	NS	--	--	NS	--	--	NS	--	--	NS	--	--	
trans-1,2-DCE Reductase (TDR)	NS	--	--	NS	--	--	NS	--	--	NS	--	--	
Trichlorobenzene Dioxygenase (TCBO)	NS	--	--	NS	--	--	NS	--	--	NS	--	--	
Vinyl Chloride Reductase (VCR)	NS	--	--	NS	--	--	NS	--	--	NS	--	--	
EDB (µg/L) EPA Method 8011	1,2-DIBROMOETHANE	2.9		0.03	0.94		0.006	1.2		0.003	0.68		0.0031
VFAs (mg/L) EPA Method 300m	ACETIC ACID	39.5		10	49.3		10	67.3		10	22.4		1
	BUTYRIC ACID	ND	U	1	ND	U	1	ND	U	1	ND	U	1
	FORMIC ACID	1	J	10	1	J	10	0.9	J	10	1	J	10
	LACTIC ACID	1.1		1	0.5	J	1	0.4	J	1	0.6	J	1
	PROPIONIC ACID	ND	U	1	ND	U	1	6.8	J	10	ND	U	1
	PYRUVIC ACID	ND	U	1	ND	U	1	ND	U	1	ND	U	1
VALERIC ACID	ND	U	1	ND	U	1	ND	U	1	ND	U	1	
Fluorometric (µg/L) Spectrofluorophotometry	FLUORESCCEIN	NS	--	--	NS	--	--	NS	--	--	NS	--	--
Reduced Gases (µg/L) RSKSOP-175	ACETYLENE	ND	U	10	ND	U	10	ND	U	10	ND	U	10
	ETHANE	1.1	J	4	1.3	J	4	1.7	J	4	1.7	J	4
	ETHYLENE	3.8	J	5	6.3		5	8.6		5	7.8		5
	METHANE	14.8		2	13.8		2	18.9		2	14		2
	PROPANE	1.2	J	6	1.4	J	6	1.6	J	6	ND	U	6
General Chemistry (mg/L) SM2320b, EPA Method 300, EPA Method 353.2, SM4500 Pec	ALKALINITY	410		5	430		5	440		5	420		5
	BROMIDE	0.8		0.5	1		0.5	0.98		0.5	2.1		0.5
	CHLORIDE	49		0.5	51		0.5	55		0.5	50		0.5
	IODIDE	13		0.75	15		0.75	12		0.75	15		0.75
	NITRATE	NA	--	--	NA	--	--	NA	--	--	NA	--	--
	NITRITE	NA	--	--	NA	--	--	NA	--	--	NA	--	--
	NITROGEN, NITRATE-NITRITE	ND		0.05	ND	U	0.05	ND	U	0.1	ND	U	0.05
	O-PHOSPHATE (AS P)	NA	--	--	NA	--	--	NA	--	--	NA	--	--
	ORTHOPHOSPHATE	ND		0.15	ND	U	0.15	ND	U	0.15	ND	UJ	0.15
	PHOSPHORUS	NA	--	--	NA	--	--	NA	--	--	NA	--	--
SULFATE	2.1		1	ND	U	1	ND	U	1	ND	U	1	

Table 12
Analytical Data Table for KAFB-106MW1-I

Phase Designation		Phase 3 Recirculation						Phase 3 Passive					
Sample ID		106MW1-P3R-082118-FD			106MW1-P3R-082818			106MW1-P3P-091118			106MW1-P3P-100318		
Sample Date		8/21/2018			8/28/2018			9/11/2018			10/3/2018		
Sample Purpose		FD			REG			REG			REG		
Chemical Class and Analytical Method ^a	Parameter	Result	Val Qual	LOQ	Result	Val Qual	LOQ	Result	Val Qual	LOQ	Result	Val Qual	LOQ
Metals (mg/L) EPA Method 6010	LEAD	NS	--	--	NS	--	--	NS	--	--	NS	--	--
Dissolved Metals (mg/L) EPA Method 6010	IRON	7.1		0.05	7.4		0.05	7.1		0.05	8.8		0.05
	MANGANESE	4.3		0.003	4.3		0.003	4		0.003	3.4		0.003
δ2H (‰) Mass Spectrometry, USGS Reston, VA	DELTA2H	NS	--	--	NS	--	--	NS	--	--	NS	--	--
VOCs (µg/L) EPA Method 8260	1,1,2-TRICHLOROETHANE	ND	U	2.5	ND	U	50	ND	U	50	ND	U	50
	1,2,4-TRICHLOROBENZENE	NA	--	--	NA	--	--	NA	--	--	NA	--	--
	1,2,4-TRIMETHYLBENZENE	360		5	450		100	440		100	410		100
	1,2-DIBROMOETHANE	3.4	J	5	ND	U	100	ND	U	100	ND	U	100
	1,2-DICHLOROETHANE	3.6	J	5	ND	U	100	ND	U	100	ND	U	100
	1,3,5-TRIMETHYLBENZENE	110		2.5	140		50	140		50	130		50
	2-BUTANONE	49	J	50	ND	U	1000	ND	U	1000	ND	U	1000
	2-CHLOROTOLUENE	ND	U	2.5	ND	U	50	ND	U	50	ND	U	50
	2-HEXANONE	82		25	ND	U	500	ND	U	500	ND	U	500
	4-METHYL-2-PENTANONE	76		25	ND	U	500	ND	U	500	ND	U	500
	ACETONE	180		50	ND	U	1000	ND	U	1000	ND	U	1000
	BENZENE	2900		50	3600		100	3100		100	3100		100
	CARBON DISULFIDE	ND	U	10	ND	U	200	ND	U	200	ND	U	200
	CHLOROMETHANE	ND	U	5	ND	U	100	ND	U	100	ND	U	100
	CIS-1,2-DICHLOROETHENE	NA	--	--	NA	--	--	NA	--	--	NA	--	--
	DICHLORODIFLUOROMETHANE	ND	U	5	ND	U	100	ND	U	100	ND	U	100
	ETHYLBENZENE	980		5	1300		100	1500		100	1000		100
	ISOPROPYLBENZENE	120		5	150		100	150		100	180		100
	M,P-XYLENES	NA	--	--	NA	--	--	NA	--	--	NA	--	--
	METHYL TERT-BUTYL ETHER	ND	U	2.5	ND	U	50	ND	U	50	ND	U	50
	METHYLENE CHLORIDE	ND	U	25	490	J	500	ND	U	500	ND	U	500
	NAPHTHALENE	130		25	ND	U	500	ND	U	500	ND	U	500
	N-BUTYLBENZENE	14		5	ND	U	100	ND	U	100	ND	U	100
	N-PROPYLBENZENE	110		5	130		100	140		100	120		100
	O-XYLENE	NA	--	--	NA	--	--	NA	--	--	NA	--	--
	P-ISOPROPYLTOLUENE	40		5	ND	U	100	ND	U	100	ND	U	100
	SEC-BUTYLBENZENE	13		5	ND	U	100	ND	U	100	ND	U	100
	TERT-BUTYLBENZENE	ND	U	5	ND	U	100	ND	U	100	ND	U	100
	TETRACHLOROETHENE	NA	--	--	NA	--	--	NA	--	--	NA	--	--
	TOLUENE	5100		50	5900		100	7300		100	3200		100
	TRANS-1,2-DICHLOROETHENE	NA	--	--	NA	--	--	NA	--	--	NA	--	--
	TRICHLOROETHENE	ND	U	5	ND	U	100	ND	U	100	ND	U	100
	TRICHLOROFUOROMETHANE	ND	U	5	ND	U	100	ND	U	100	ND	U	100
	VINYL CHLORIDE	NA	--	--	NA	--	--	NA	--	--	NA	--	--
	XYLENES	3300		25	4600		50	4700		50	3800		50

Refer to notes at the end of the table.

Table 12
Analytical Data Table for KAFB-106MW1-I

Phase Designation		Phase 3 Passive			Phase 4 Passive			Phase 4 Passive			Phase 4 Passive		
Sample ID		106MW11-P3P-111418			106MW11-P4P-011619			106MW11-LTM-031220			106MW11-LTM-051920		
Sample Date		11/14/2018			1/16/2019			3/12/2020			5/19/2020		
Sample Purpose		REG			REG			REG			REG		
Chemical Class and Analytical Method ^a	Parameter	Result	Val Qual	LOQ	Result	Val Qual	LOQ	Result	Val Qual	LOQ	Result	Val Qual	LOQ
Microbial Community (cells/mL) QuantArray-Chlor	1,1 DCA Reductase (DCA)	ND	U	4.9	ND	U	4.9	ND	U	4.8	ND	U	5
	1,2 DCA Reductase (DCAR)	ND	U	4.9	ND	U	4.9	ND	U	4.8	ND	U	5
	BAV1 Vinyl Chloride Reductase (BVC)	ND	U	0.5	ND	U	0.5	ND	U	0.5	ND	U	0.5
	cer A Reductase	ND	U	4.9	ND	U	4.9	ND	U	4.8	ND	U	5
	Chloroform Reductase (CFR)	ND	U	4.9	ND	U	4.9	ND	U	4.8	ND	U	5
	Dehalobacter DCM (DCM)	5900		4.9	3200		4.9	ND	U	4.8	539		5
	Dehalobacter spp. (DHBt)	340000		4.9	304000		4.9	97900		4.8	394000		5
	Dehalobium chlorocoercia (DECO)	7860		4.9	12900		4.9	2160		4.8	41900		5
	Dehalococcoides (DHC)	ND	U	0.5	0.7		0.5	0.4	J	0.5	0.5		0.5
	Dehalogenimonas spp. (DHG)	6680		4.9	6090		4.9	455		4.8	6830		5
	Desulfotobacterium spp. (DSB)	93700		4.9	92900		4.9	46000		4.8	107000		5
	Desulfuromonas spp. (DSM)	ND	U	4.9	35.6		4.9	ND	U	4.8	ND	U	5
	Dichloromethane Dehalogenase (DCMA)	ND	U	4.9	ND	U	4.9	ND	U	4.8	ND	U	5
	Epoxyalkane Transferase (EtnE)	75.6		4.9	294		4.9	155		4.8	ND	U	5
	Ethene Monooxygenase (EtnC)	ND	U	4.9	112		4.9	ND	U	4.8	ND	U	5
	Methanogens (MGN)	ND	U	4.9	50.8		4.9	6620		4.8	654		5
	PCE Reductase (PCE-1)	ND	U	4.9	ND	U	4.9	ND	U	4.8	ND	U	5
	Phenol Hydroxylase (PHE)	2210		4.9	5110		4.9	154		4.8	10400		5
	PMMO	NA	--	--	NA	--	--	NA	--	--	NA	--	--
	Soluble Methane Monooxygenase (SMMO)	ND	U	4.9	67.2		4.9	ND	U	4.8	ND	U	5
	Sulfate Reducing Bacteria (APS)	59300		4.9	930000		4.9	145000		4.8	965000		5
tceA Reductase (TCE)	ND	U	0.5	ND	U	0.5	ND	U	0.5	ND	U	0.5	
Toluene Dioxygenase (TOD)	ND	U	4.9	ND	U	4.9	75.3		4.8	ND	U	5	
Toluene Monooxygenase (RMO)	7030		4.9	14000		4.9	184		4.8	12300		5	
Toluene Monooxygenase 2 (RDEG)	2180		4.9	12700		4.9	983		4.8	6640		5	
Total Eubacteria (EBAC)	3360000		4.9	10900000		4.9	9130000		4.8	25900000		5	
trans-1,2-DCE Reductase (TDR)	ND	U	4.9	ND	U	4.9	ND	U	4.8	ND	U	5	
Trichlorobenzene Dioxygenase (TCBO)	ND	U	4.9	ND	U	4.9	ND	U	4.8	ND	U	5	
Vinyl Chloride Reductase (VCR)	ND	U	0.5	0.2	J	0.5	ND	U	0.5	ND	U	0.5	
EDB (µg/L) EPA Method 8011	1,2-DIBROMOETHANE	0.77		0.0029	0.22	J-	0.0015	ND	U	0.011	ND	U	0.01
VFAs (mg/L) EPA Method 300m	ACETIC ACID	8.4		1	10.1		1	0.8	J	10	ND	U	10
	BUTYRIC ACID	ND	U	1	ND	U	1	ND	U	1	ND	U	10
	FORMIC ACID	0.4	J	1	ND	U	1	0.8	J	10	0.5	J	10
	LACTIC ACID	1		1	0.7	J	1	0.8	J	10	ND	U	10
	PROPIONIC ACID	ND	U	1	ND	U	1	ND	U	1	ND	U	10
	PYRUVIC ACID	ND	U	1	ND	U	1	ND	U	1	ND	U	10
VALERIC ACID	ND	U	1	ND	U	1	ND	U	1	ND	U	10	
Fluorometric (µg/L) Spectrofluorophotometry	FLUORESCCEIN	NS	--	--	NS	--	--	NS	--	--	NS	--	--
Reduced Gases (µg/L) RSKSOP-175	ACETYLENE	ND	U	10	ND	U	10	ND	U	10	ND	U	10
	ETHANE	1.4	J	4	1	J	4	ND	U	4	2.3	J	4
	ETHYLENE	6.7		5	2.2	J	5	ND	U	5	ND	U	5
	METHANE	14.5		2	8.4		2	21.9		2	42.2		2
	PROPANE	1	J	6	1.4	J	6	ND	U	6	2.5	J	6
General Chemistry (mg/L) SM2320b, EPA Method 300, EPA Method 353.2, SM4500 Pec	ALKALINITY	420		5	360		5	400		5	357		5
	BROMIDE	1.2		0.5	1.1		0.5	0.884		0.1	0.91		0.1
	CHLORIDE	48		0.5	50		0.5	56.8		0.5	68.5		0.5
	IODIDE	16	J+	0.75	13		0.75	4.6		0.2	3.2		0.2
	NITRATE	NA	--	--	NA	--	--	ND	U	0.1	ND	U	0.1
	NITRITE	NA	--	--	NA	--	--	NA	--	--	NA	--	--
	NITROGEN, NITRATE-NITRITE	ND	U	0.05	ND	UJ	0.05	ND	U	0.1	ND	U	0.1
	O-PHOSPHATE (AS P)	NA	--	--	NA	--	--	NA	--	--	NA	--	--
	ORTHOPHOSPHATE	ND	U	0.15	ND	U	0.15	NA	--	--	NA	--	--
	PHOSPHORUS	NA	--	--	NA	--	--	ND	U	0.025	ND	U	0.025
SULFATE	ND	U	1	ND	U	1	3.63		0.5	10.6		0.5	

Table 12
Analytical Data Table for KAFB-106MW1-I

Phase Designation		Phase 3 Passive			Phase 4 Passive			Phase 4 Passive			Phase 4 Passive		
Sample ID		106MW11-P3P-111418			106MW11-P4P-011619			106MW11-LTM-031220			106MW11-LTM-051920		
Sample Date		11/14/2018			1/16/2019			3/12/2020			5/19/2020		
Sample Purpose		REG			REG			REG			REG		
Chemical Class and Analytical Method ^a	Parameter	Result	Val Qual	LOQ	Result	Val Qual	LOQ	Result	Val Qual	LOQ	Result	Val Qual	LOQ
Metals (mg/L) EPA Method 6010	LEAD	NS	--	--	NS	--	--	ND	U	0.001	ND	U	0.001
Dissolved Metals (mg/L) EPA Method 6010	IRON	7.1		0.05	5.8		0.05	6.45		0.05	4.76		0.05
	MANGANESE	3.2		0.003	2.6		0.003	3.44		0.05	3.3		0.05
δ2H (‰) Mass Spectrometry, USGS Reston, VA	DELTA2H	NS	--	--	NS	--	--	NS	--	--	NS	--	--
VOCs (µg/L) EPA Method 8260	1,1,2-TRICHLOROETHANE	ND	U	50	ND	U	13	ND	U	0.5	ND	U	1
	1,2,4-TRICHLOROBENZENE	NA	--	--	NA	--	--	ND	U	0.5	ND	U	1
	1,2,4-TRIMETHYLBENZENE	380		100	290		25	NA	--	--	NA	--	--
	1,2-DIBROMOETHANE	ND	U	100	ND	U	25	ND	U	0.5	ND	U	0.5
	1,2-DICHLOROETHANE	ND	U	100	NA	--	--	ND	U	0.5	ND	U	0.5
	1,3,5-TRIMETHYLBENZENE	130		50	50		13	5.6		0.5	2.7		1
	2-BUTANONE	ND	U	1000	ND	U	250	1	J	1	1.7	J	1
	2-CHLOROTOLUENE	ND	U	50	ND	U	13	ND	U	0.5	ND	U	1
	2-HEXANONE	ND	U	500	ND	U	130	ND	U	1	ND	U	2
	4-METHYL-2-PENTANONE	ND	U	500	ND	U	130	ND	U	1	ND	U	2
	ACETONE	ND	U	1000	ND	U	250	ND	U	1	7.7		1
	BENZENE	3300		100	2200		25	560		2.5	450		2.5
	CARBON DISULFIDE	ND	U	200	ND	U	50	ND	U	1	ND	U	1
	CHLOROMETHANE	ND	U	100	ND	U	25	ND	U	0.5	ND	U	0.5
	CIS-1,2-DICHLOROETHENE	NA	--	--	NA	--	--	ND	U	0.5	ND	U	0.5
	DICHLORODIFLUOROMETHANE	ND	U	100	NA	--	--	ND	U	0.5	ND	U	1
	ETHYLBENZENE	1300		100	NA	--	--	390		2.5	290		5
	ISOPROPYLBENZENE	170		100	160		25	95		0.5	59		1
	M,P-XYLENES	NA	--	--	NA	--	--	380		5	290		1
	METHYL TERT-BUTYL ETHER	ND	U	50	ND	U	13	ND	U	0.5	ND	U	0.5
	METHYLENE CHLORIDE	ND	U	500	ND	U	130	ND	U	1	ND	U	1
	NAPHTHALENE	ND	U	500	94	J	130	42		0.5	33		1
	N-BUTYLBENZENE	ND	U	100	15	J	25	6.8		0.5	4.3		1
	N-PROPYLBENZENE	130		100	86		25	45		0.5	26		1
	O-XYLENE	NA	--	--	NA	--	--	200		2.5	180		1
	P-ISOPROPYLTOLUENE	ND	U	100	49		25	110		0.5	85		1
	SEC-BUTYLBENZENE	ND	U	100	20	J	25	12		0.5	7.2		1
	TERT-BUTYLBENZENE	ND	U	100	ND	U	25	ND	U	0.5	ND	U	1
	TETRACHLOROETHENE	NA	--	--	NA	--	--	ND	U	0.5	ND	U	1
	TOLUENE	2100		100	740		25	3.5		0.5	2.4		0.5
	TRANS-1,2-DICHLOROETHENE	NA	--	--	NA	--	--	ND	U	0.5	ND	U	0.5
	TRICHLOROETHENE	ND	U	100	ND	U	25	ND	U	0.5	ND	U	0.5
	TRICHLOROFUOROMETHANE	ND	U	100	ND	U	25	ND	U	0.5	ND	U	1
	VINYL CHLORIDE	NA	--	--	NA	--	--	ND	U	0.5	ND	U	0.5
	XYLENES	3900		50	1600		13	580		2.5	480		1

Refer to notes at the end of the table.

Table 12
Analytical Data Table for KAFB-106MW1-I

Phase Designation		Phase 4 Passive					
Sample ID		106MW1-LTM-080520			106MW1-LTM-101320		
Sample Date		8/5/2020			10/13/2020		
Sample Purpose		REG			REG		
Chemical Class and Analytical Method ^a	Parameter	Result	Val Qual	LOQ	Result	Val Qual	LOQ
Microbial Community (cells/mL) QuantArray-Chlor	1,1 DCA Reductase (DCA)	ND	U	5.4	4.8		4.8
	1,2 DCA Reductase (DCAR)	ND	U	5.4	4.8		4.8
	BAV1 Vinyl Chloride Reductase (BVC)	ND	U	0.5	0.1		0.5
	cer A Reductase	ND	U	5.4	4.8		4.8
	Chloroform Reductase (CFR)	ND	U	5.4	4.8		4.8
	Dehalobacter DCM (DCM)	189		5.4	4.8		4.8
	Dehalobacter spp. (DHBt)	202000		5.4	82800		4.8
	Dehalobium chlorocoercia (DECO)	50000		5.4	10800		4.8
	Dehalococcoides (DHC)	0.7		0.5	6.9		0.5
	Dehalogenimonas spp. (DHG)	861		5.4	4.8		4.8
	Desulfotobacterium spp. (DSB)	71200		5.4	11200		4.8
	Desulfuromonas spp. (DSM)	ND	U	5.4	4.8		4.8
	Dichloromethane Dehalogenase (DCMA)	ND	U	5.4	4.8		4.8
	Epoxyalkane Transferase (EtnE)	63.4		5.4	4.8		4.8
	Ethene Monooxygenase (EtnC)	29.2		5.4	4.8		4.8
	Methanogens (MGN)	652		5.4	357		4.8
	PCE Reductase (PCE-1)	ND	U	5.4	4.8		4.8
	Phenol Hydroxylase (PHE)	1450		5.4	1750		4.8
	PMMO	NA	--	--	NA	--	--
	Soluble Methane Monooxygenase (SMMO)	ND	U	5.4	4.8		4.8
	Sulfate Reducing Bacteria (APS)	622000		5.4	355000		4.8
	tceA Reductase (TCE)	ND	U	0.5	0.5		0.5
	Toluene Dioxygenase (TOD)	ND	U	5.4	87.5		4.8
	Toluene Monooxygenase (RMO)	5780		5.4	3080		4.8
	Toluene Monooxygenase 2 (RDEG)	3540		5.4	1660		4.8
	Total Eubacteria (EBAC)	13500000		5.4	14200000		4.8
	trans-1,2-DCE Reductase (TDR)	ND	U	5.4	4.8		4.8
	Trichlorobenzene Dioxygenase (TCBO)	ND	U	5.4	4.8		4.8
	Vinyl Chloride Reductase (VCR)	ND	U	0.5	0.7		0.5
	EDB (µg/L) EPA Method 8011	1,2-DIBROMOETHANE	ND	U	0.01	ND	U
VFAs (mg/L) EPA Method 300m	ACETIC ACID	ND	U	10	ND	U	10
	BUTYRIC ACID	ND	U	10	ND	U	10
	FORMIC ACID	1.1	J	10	1.5	J	10
	LACTIC ACID	1.1	J	10	0.6	J	10
	PROPIONIC ACID	ND	U	10	ND	U	10
	PYRUVIC ACID	ND	U	10	ND	U	10
VALERIC ACID	ND	U	10	ND	U	10	
Fluorometric (µg/L) Spectrofluorophotometry	FLUORESCCEIN	NS	--	--	NS	--	--
Reduced Gases (µg/L) RSKSOP-175	ACETYLENE	ND	U	10	ND	U	10
	ETHANE	3	J	4	2.4	J	4
	ETHYLENE	ND	U	5	ND	U	5
	METHANE	80.9		2	71.5		20
	PROPANE	2.8	J	6	2.8	J	6
General Chemistry (mg/L) SM2320b, EPA Method 300, EPA Method 353.2, SM4500 Pec	ALKALINITY	394		5	359		5
	BROMIDE	1.94		0.1	1.74		0.1
	CHLORIDE	59.8		0.5	59.1		0.5
	IODIDE	4.1		2	1.4		
	NITRATE	0.1		0.1	ND	U	0.1
	NITRITE	NA	--	--	NA	--	--
	NITROGEN, NITRATE-NITRITE	ND	U	0.1	ND	U	0.1
	O-PHOSPHATE (AS P)	NA	--	--	NA	--	--
	ORTHOPHOSPHATE	NA	--	--	NA	--	--
	PHOSPHORUS	ND	U	0.025	ND	U	0.025
SULFATE	12.9		0.5	8.35		0.5	

Table 12
Analytical Data Table for KAFB-106MW1-I

Phase Designation		Phase 4 Passive					
Sample ID		106MW11-LTM-080520			106MW11-LTM-101320		
Sample Date		8/5/2020			10/13/2020		
Sample Purpose		REG			REG		
Chemical Class and Analytical Method ^a	Parameter	Result	Val Qual	LOQ	Result	Val Qual	LOQ
Metals (mg/L) EPA Method 6010	LEAD	ND	U	0.001	ND	U	0.001
Dissolved Metals (mg/L) EPA Method 6010	IRON	7.23		0.05	5.37		0.05
	MANGANESE	4.28		0.125	3.59		0.125
δ2H (‰) Mass Spectrometry, USGS Reston, VA	DELTA2H	NS	--	--	NS	--	--
VOCs (µg/L) EPA Method 8260	1,1,2-TRICHLOROETHANE	ND	U	1	ND	U	1
	1,2,4-TRICHLOROBENZENE	ND	U	1	ND	U	1
	1,2,4-TRIMETHYLBENZENE	NA	--	--	NA	--	--
	1,2-DIBROMOETHANE	ND	U	0.5	ND	U	0.5
	1,2-DICHLOROETHANE	ND	U	0.5	ND	U	0.5
	1,3,5-TRIMETHYLBENZENE	ND	U	1	ND	U	0.5
	2-BUTANONE	ND	U	1	ND	U	1
	2-CHLOROTOLUENE	ND	U	1	ND	U	1
	2-HEXANONE	ND	U	2	ND	U	2
	4-METHYL-2-PENTANONE	ND	U	1	ND	U	2
	ACETONE	15		1	8.9		1
	BENZENE	660		5	65	J+	0.5
	CARBON DISULFIDE	ND	U	1	ND	U	2
	CHLOROMETHANE	ND	U	0.5	ND	U	0.5
	CIS-1,2-DICHLOROETHENE	ND	U	0.5	ND	U	0.5
	DICHLORODIFLUOROMETHANE	ND	U	1	ND	U	0.5
	ETHYLBENZENE	520		10	180		1
	ISOPROPYLBENZENE	94		1	70	J+	0.5
	M,P-XYLENES	400		10	17	J+	1
	METHYL TERT-BUTYL ETHER	ND	U	0.5	ND	U	0.5
	METHYLENE CHLORIDE	ND	U	1	ND	U	1
	NAPHTHALENE	58		1	18	J+	0.5
	N-BUTYLBENZENE	10		1	8	J+	1
	N-PROPYLBENZENE	57		1	23	J+	1
	O-XYLENE	240		10	11	J+	1
	P-ISOPROPYLTOLUENE	99		1	96		0.5
	SEC-BUTYLBENZENE	15		1	12	J+	0.5
	TERT-BUTYLBENZENE	ND	U	1	ND	U	1
	TETRACHLOROETHENE	ND	U	1	ND	U	0.5
	TOLUENE	ND	U	0.5	1.5	J+	0.5
	TRANS-1,2-DICHLOROETHENE	ND	U	0.5	ND	U	0.5
	TRICHLOROETHENE	ND	U	0.5	ND	U	0.5
	TRICHLOROFLUOROMETHANE	ND	U	1	ND	U	1
	VINYL CHLORIDE	ND	U	0.5	ND	U	0.5
	XYLENES	640		10	28	J+	0.5

Refer to notes at the end of the table.

Table 12
Analytical Data Table for KAFB-106MW1-I

Notes:

Sampling frequency for each analytical method is outlined in Table 4.

a. EPA analytical methods listed are for the most recent sampling event.

b. Samples were collected using Geotech Bladder Pumps.

c. Samples were recollected (except for QuantArray-Chlor analysis) using replacement QED Bladder Pumps.

-- = Not applicable.

δ2H - Delta Deuterium.

0/00 - Per mil.

cells/mL = Cells per milliliter.

EPA = Environmental Protection Agency.

FD = Field duplicate.

ID = Identification.

J = Estimated value, concentration is less than LOQ but greater than laboratory method detection limit (DL).

J+ = Estimated value, concentration is less than LOQ but greater than laboratory method detection limit (DL); biased high.

J- = Estimated value, concentration is less than LOQ but greater than laboratory method detection limit (DL); biased low.

KAFB = Kirtland Air Force Base.

LOQ = Limit of Quantitation

µg/L = Microgram per liter.

mg/L = Milligram per liter.

NA = Not analyzed.

ND = Not detected.

NS = Not sampled.

REG = Regular/parent sample.

U = Analyte was not detected. The reported numerical value is at or below the LOQ.

UJ = Analyte was not detected. The reported value is estimated.

VAL QUAL = Validation qualifier.

VFA - Volatile fatty acid.

VOC = Volatile organic compound.

Table 13
Analytical Data Table for KAFB-106MW1-S

Phase Designation		Baseline - QED Pumps ^b			Phase 1 Recirculation								
Sample ID		106MW1S-BL-091917			106MW1S-P1R-100417			106MW1S-P1R-100617			106MW1S-P1R-100617-FD		
Sample Date		9/19/2017			10/4/2017			10/6/2017			10/6/2017		
Sample Purpose		REG			REG			REG			FD		
Chemical Class and Analytical Method ^a	Parameter	Result	Val Qual	LOQ	Result	Val Qual	LOQ	Result	Val Qual	LOQ	Result	Val Qual	LOQ
Microbial Community (cells/mL) QuantArray-Chlor	1,1 DCA Reductase (DCA)	ND	U	5.5	NS	--	--	NS	--	--	NS	--	--
	1,2 DCA Reductase (DCAR)	ND	U	5.5	NS	--	--	NS	--	--	NS	--	--
	BAV1 Vinyl Chloride Reductase (BVC)	ND	U	0.5	NS	--	--	NS	--	--	NS	--	--
	cer A Reductase	NA	--	--	NS	--	--	NS	--	--	NS	--	--
	Chloroform Reductase (CFR)	ND	U	5.5	NS	--	--	NS	--	--	NS	--	--
	Dehalobacter DCM (DCM)	ND	U	5.5	NS	--	--	NS	--	--	NS	--	--
	Dehalobacter spp. (DHBt)	12900		5.5	NS	--	--	NS	--	--	NS	--	--
	Dehalobium chlorocoercia (DECO)	2150		5.5	NS	--	--	NS	--	--	NS	--	--
	Dehalococcoides (DHC)	ND	U	0.5	NS	--	--	NS	--	--	NS	--	--
	Dehalogenimonas spp. (DHG)	ND	U	5.5	NS	--	--	NS	--	--	NS	--	--
	Desulfitobacterium spp. (DSB)	122000		5.5	NS	--	--	NS	--	--	NS	--	--
	Desulfuromonas spp. (DSM)	ND	U	5.5	NS	--	--	NS	--	--	NS	--	--
	Dichloromethane Dehalogenase (DCMA)	ND	U	5.5	NS	--	--	NS	--	--	NS	--	--
	Epoxyalkane Transferase (EtnE)	ND	U	5.5	NS	--	--	NS	--	--	NS	--	--
	Ethene Monooxygenase (EtnC)	ND	U	5.5	NS	--	--	NS	--	--	NS	--	--
	Methanogens (MGN)	52.4		5.5	NS	--	--	NS	--	--	NS	--	--
	PCE Reductase (PCE-1)	NA	--	--	NS	--	--	NS	--	--	NS	--	--
	Phenol Hydroxylase (PHE)	51600		5.5	NS	--	--	NS	--	--	NS	--	--
	PMMO	87.7		5.5	NS	--	--	NS	--	--	NS	--	--
	Soluble Methane Monooxygenase (SMMO)	272		5.5	NS	--	--	NS	--	--	NS	--	--
Sulfate Reducing Bacteria (APS)	76800		5.5	NS	--	--	NS	--	--	NS	--	--	
tceA Reductase (TCE)	ND	U	0.5	NS	--	--	NS	--	--	NS	--	--	
Toluene Dioxygenase (TOD)	1680		5.5	NS	--	--	NS	--	--	NS	--	--	
Toluene Monooxygenase (RMO)	80500		5.5	NS	--	--	NS	--	--	NS	--	--	
Toluene Monooxygenase 2 (RDEG)	48100		5.5	NS	--	--	NS	--	--	NS	--	--	
Total Eubacteria (EBAC)	13300000		5.5	NS	--	--	NS	--	--	NS	--	--	
trans-1,2-DCE Reductase (TDR)	NA	--	--	NS	--	--	NS	--	--	NS	--	--	
Trichlorobenzene Dioxygenase (TCBO)	ND	U	5.5	NS	--	--	NS	--	--	NS	--	--	
Vinyl Chloride Reductase (VCR)	ND	U	0.5	NS	--	--	NS	--	--	NS	--	--	
EDB (µg/L) EPA Method 8011	1,2-DIBROMOETHANE	432	J+	9.66	NS	--	--	NS	--	--	NS	--	--
VFAs (mg/L) EPA Method 300m	ACETIC ACID	1.29		1	NS	--	--	NS	--	--	NS	--	--
	BUTYRIC ACID	ND	U	1	NS	--	--	NS	--	--	NS	--	--
	FORMIC ACID	ND	U	1	NS	--	--	NS	--	--	NS	--	--
	LACTIC ACID	0.62	J	1	NS	--	--	NS	--	--	NS	--	--
	PROPIONIC ACID	ND	U	1	NS	--	--	NS	--	--	NS	--	--
	PYRUVIC ACID	ND	U	1	NS	--	--	NS	--	--	NS	--	--
VALERIC ACID	ND	U	1	NS	--	--	NS	--	--	NS	--	--	
Fluorometric (µg/L) Spectrofluorophotometry	FLUORESCEIN	ND	U	0.01	ND	U	0.01	ND	U	0.01	ND	U	0.01
Reduced Gases (µg/L) RSKSOP-175	ACETYLENE	ND	U	10	NS	--	--	NS	--	--	NS	--	--
	ETHANE	2.48	J	4	NS	--	--	NS	--	--	NS	--	--
	ETHYLENE	6.35		5	NS	--	--	NS	--	--	NS	--	--
	METHANE	2		2	NS	--	--	NS	--	--	NS	--	--
	PROPANE	3.34	J	6	NS	--	--	NS	--	--	NS	--	--
General Chemistry (mg/L) SM2320b, EPA Method 300, EPA Method 353.2, SM4500 PE ^c	ALKALINITY	386		1	NS	--	--	NS	--	--	NS	--	--
	BROMIDE	0.329		0.125	NS	--	--	NS	--	--	NS	--	--
	CHLORIDE	32.7		0.33	NS	--	--	NS	--	--	NS	--	--
	IODIDE	ND	U	0.75	NS	--	--	NS	--	--	NS	--	--
	NITRATE	NA	--	--	NS	--	--	NS	--	--	NS	--	--
	NITRITE	NA	--	--	NS	--	--	NS	--	--	NS	--	--
	NITROGEN, NITRATE-NITRITE	ND	U	0.375	NS	--	--	NS	--	--	NS	--	--

Table 13
Analytical Data Table for KAFB-106MW1-S

Phase Designation		Baseline - QED Pumps ^b			Phase 1 Recirculation								
Sample ID		106MW1S-BL-091917			106MW1S-P1R-100417			106MW1S-P1R-100617			106MW1S-P1R-100617-FD		
Sample Date		9/19/2017			10/4/2017			10/6/2017			10/6/2017		
Sample Purpose		REG			REG			REG			FD		
Chemical Class and Analytical Method ^a	Parameter	Result	Val Qual	LOQ	Result	Val Qual	LOQ	Result	Val Qual	LOQ	Result	Val Qual	LOQ
General Chemistry (mg/L) SM2320b, EPA Method 300, EPA Method 353.2, SM4500 Pec	O-PHOSPHATE (AS P)	0.0525		0.02	NS	--	--	NS	--	--	NS	--	--
	ORTHOPHOSPHATE	NA	--	--	NS	--	--	NS	--	--	NS	--	--
	PHOSPHORUS	NA	--	--	NS	--	--	NS	--	--	NS	--	--
	SULFATE	3.43		1	NS	--	--	NS	--	--	NS	--	--
Metals (mg/L) EPA Method 6010	LEAD	NS	--	--	NS	--	--	NS	--	--	NS	--	--
Dissolved Metals (mg/L) EPA Method 6010	IRON	1.02		0.06	NS	--	--	NS	--	--	NS	--	--
	MANGANESE	2.62		0.006	NS	--	--	NS	--	--	NS	--	--
δ2H (‰) Mass Spectrometry, USGS Reston, VA	DELTA2H	-93.89		-99	-95.45		-99	-96.06		-99	-95.87		-99
CSIA EDB δ13C (‰) Kuder et al, 2012	EDB δ	-19.6 ±2‰	--	--	NS	--	--	NS	--	--	NS	--	--
VOCs (µg/L) EPA Method 8260	1,1,2-TRICHLOROETHANE	ND	UJ	100	NS	--	--	NS	--	--	NS	--	--
	1,2,4-TRICHLOROBENZENE	NA	--	--	NS	--	--	NS	--	--	NS	--	--
	1,2,4-TRIMETHYLBENZENE	469	J-	100	NS	--	--	NS	--	--	NS	--	--
	1,2-DIBROMOETHANE	415	J-	100	NS	--	--	NS	--	--	NS	--	--
	1,2-DICHLOROETHANE	ND	UJ	100	NS	--	--	NS	--	--	NS	--	--
	1,3,5-TRIMETHYLBENZENE	165	J-	100	NS	--	--	NS	--	--	NS	--	--
	2-BUTANONE	ND	UJ	1000	NS	--	--	NS	--	--	NS	--	--
	2-CHLOROTOLUENE	ND	UJ	100	NS	--	--	NS	--	--	NS	--	--
	2-HEXANONE	523	J-	500	NS	--	--	NS	--	--	NS	--	--
	4-METHYL-2-PENTANONE	ND	UJ	500	NS	--	--	NS	--	--	NS	--	--
	ACETONE	2210	J-	1000	NS	--	--	NS	--	--	NS	--	--
	BENZENE	7320	J-	100	NS	--	--	NS	--	--	NS	--	--
	CARBON DISULFIDE	ND	UJ	100	NS	--	--	NS	--	--	NS	--	--
	CHLOROMETHANE	ND	UJ	100	NS	--	--	NS	--	--	NS	--	--
	CIS-1,2-DICHLOROETHENE	NA	--	--	NS	--	--	NS	--	--	NS	--	--
	DICHLORODIFLUOROMETHANE	ND	UJ	200	NS	--	--	NS	--	--	NS	--	--
	ETHYLBENZENE	1460	J-	100	NS	--	--	NS	--	--	NS	--	--
	ISOPROPYLBENZENE	113	J	100	NS	--	--	NS	--	--	NS	--	--
	M,P-XYLENES	NA	--	--	NS	--	--	NS	--	--	NS	--	--
	METHYL TERT-BUTYL ETHER	ND	UJ	100	NS	--	--	NS	--	--	NS	--	--
	METHYLENE CHLORIDE	ND	UJ	200	NS	--	--	NS	--	--	NS	--	--
	NAPHTHALENE	141	J-	100	NS	--	--	NS	--	--	NS	--	--
	N-BUTYLBENZENE	ND	UJ	100	NS	--	--	NS	--	--	NS	--	--
	N-PROPYLBENZENE	118	J-	100	NS	--	--	NS	--	--	NS	--	--
	O-XYLENE	NA	--	--	NS	--	--	NS	--	--	NS	--	--
	P-ISOPROPYLTOLUENE	ND	UJ	100	NS	--	--	NS	--	--	NS	--	--
	SEC-BUTYLBENZENE	ND	UJ	100	NS	--	--	NS	--	--	NS	--	--
	TERT-BUTYLBENZENE	ND	UJ	100	NS	--	--	NS	--	--	NS	--	--
	TETRACHLOROETHENE	NA	--	--	NS	--	--	NS	--	--	NS	--	--
	TOLUENE	13200	J-	100	NS	--	--	NS	--	--	NS	--	--
	TRANS-1,2-DICHLOROETHENE	NA	--	--	NS	--	--	NS	--	--	NS	--	--
TRICHLOROETHENE	ND	UJ	100	NS	--	--	NS	--	--	NS	--	--	
TRICHLOROFLUOROMETHANE	ND	UJ	200	NS	--	--	NS	--	--	NS	--	--	
VINYL CHLORIDE	NA	--	--	NS	--	--	NS	--	--	NS	--	--	
XYLENES	5620	J-	300	NS	--	--	NS	--	--	NS	--	--	

Refer to notes at the end of the table.

Table 13
Analytical Data Table for KAFB-106MW1-S

Phase Designation		Phase 1 Recirculation											
Sample ID		106MW1S-P1R-100917			106MW1S-P1R-101217			106MW1S-P1R-101617			106MW1S-P1R-102017		
Sample Date		10/9/2017			10/12/2017			10/16/2017			10/20/2017		
Sample Purpose		REG			REG			REG			REG		
Chemical Class and Analytical Method ^a	Parameter	Result	Val Qual	LOQ	Result	Val Qual	LOQ	Result	Val Qual	LOQ	Result	Val Qual	LOQ
Microbial Community (cells/mL) QuantArray-Chlor	1,1 DCA Reductase (DCA)	NS	--	--	NS	--	--	NS	--	--	NS	--	--
	1,2 DCA Reductase (DCAR)	NS	--	--	NS	--	--	NS	--	--	NS	--	--
	BAV1 Vinyl Chloride Reductase (BVC)	NS	--	--	NS	--	--	NS	--	--	NS	--	--
	cer A Reductase	NS	--	--	NS	--	--	NS	--	--	NS	--	--
	Chloroform Reductase (CFR)	NS	--	--	NS	--	--	NS	--	--	NS	--	--
	Dehalobacter DCM (DCM)	NS	--	--	NS	--	--	NS	--	--	NS	--	--
	Dehalobacter spp. (DHBt)	NS	--	--	NS	--	--	NS	--	--	NS	--	--
	Dehalobium chlorocoercia (DECO)	NS	--	--	NS	--	--	NS	--	--	NS	--	--
	Dehalococcoides (DHC)	NS	--	--	NS	--	--	NS	--	--	NS	--	--
	Dehalogenimonas spp. (DHG)	NS	--	--	NS	--	--	NS	--	--	NS	--	--
	Desulfitobacterium spp. (DSB)	NS	--	--	NS	--	--	NS	--	--	NS	--	--
	Desulfuromonas spp. (DSM)	NS	--	--	NS	--	--	NS	--	--	NS	--	--
	Dichloromethane Dehalogenase (DCMA)	NS	--	--	NS	--	--	NS	--	--	NS	--	--
	Epoxyalkane Transferase (EtnE)	NS	--	--	NS	--	--	NS	--	--	NS	--	--
	Ethene Monooxygenase (EtnC)	NS	--	--	NS	--	--	NS	--	--	NS	--	--
	Methanogens (MGN)	NS	--	--	NS	--	--	NS	--	--	NS	--	--
	PCE Reductase (PCE-1)	NS	--	--	NS	--	--	NS	--	--	NS	--	--
	Phenol Hydroxylase (PHE)	NS	--	--	NS	--	--	NS	--	--	NS	--	--
	PMMO	NS	--	--	NS	--	--	NS	--	--	NS	--	--
	Soluble Methane Monooxygenase (SMMO)	NS	--	--	NS	--	--	NS	--	--	NS	--	--
Sulfate Reducing Bacteria (APS)	NS	--	--	NS	--	--	NS	--	--	NS	--	--	
tceA Reductase (TCE)	NS	--	--	NS	--	--	NS	--	--	NS	--	--	
Toluene Dioxygenase (TOD)	NS	--	--	NS	--	--	NS	--	--	NS	--	--	
Toluene Monooxygenase (RMO)	NS	--	--	NS	--	--	NS	--	--	NS	--	--	
Toluene Monooxygenase 2 (RDEG)	NS	--	--	NS	--	--	NS	--	--	NS	--	--	
Total Eubacteria (EBAC)	NS	--	--	NS	--	--	NS	--	--	NS	--	--	
trans-1,2-DCE Reductase (TDR)	NS	--	--	NS	--	--	NS	--	--	NS	--	--	
Trichlorobenzene Dioxygenase (TCBO)	NS	--	--	NS	--	--	NS	--	--	NS	--	--	
Vinyl Chloride Reductase (VCR)	NS	--	--	NS	--	--	NS	--	--	NS	--	--	
EDB (µg/L) EPA Method 8011	1,2-DIBROMOETHANE	NS	--	--	NS	--	--	NS	--	--	NS	--	--
VFAs (mg/L) EPA Method 300m	ACETIC ACID	NS	--	--	NS	--	--	NS	--	--	NS	--	--
	BUTYRIC ACID	NS	--	--	NS	--	--	NS	--	--	NS	--	--
	FORMIC ACID	NS	--	--	NS	--	--	NS	--	--	NS	--	--
	LACTIC ACID	NS	--	--	NS	--	--	NS	--	--	NS	--	--
	PROPIONIC ACID	NS	--	--	NS	--	--	NS	--	--	NS	--	--
	PYRUVIC ACID	NS	--	--	NS	--	--	NS	--	--	NS	--	--
VALERIC ACID	NS	--	--	NS	--	--	NS	--	--	NS	--	--	
Fluorometric (µg/L) Spectrofluorophotometry	FLUORESCEIN	0.151		0.01	64.884		0.01	33.977		0.01	10.78		0.01
Reduced Gases (µg/L) RSKSOP-175	ACETYLENE	NS	--	--	NS	--	--	NS	--	--	NS	--	--
	ETHANE	NS	--	--	NS	--	--	NS	--	--	NS	--	--
	ETHYLENE	NS	--	--	NS	--	--	NS	--	--	NS	--	--
	METHANE	NS	--	--	NS	--	--	NS	--	--	NS	--	--
	PROPANE	NS	--	--	NS	--	--	NS	--	--	NS	--	--
General Chemistry (mg/L) SM2320b, EPA Method 300, EPA Method 353.2, SM4500 PE ^c	ALKALINITY	NS	--	--	NS	--	--	NS	--	--	NS	--	--
	BROMIDE	NS	--	--	NS	--	--	NS	--	--	NS	--	--
	CHLORIDE	NS	--	--	NS	--	--	NS	--	--	NS	--	--
	IODIDE	NS	--	--	NS	--	--	NS	--	--	NS	--	--
	NITRATE	NS	--	--	NS	--	--	NS	--	--	NS	--	--
	NITRITE	NS	--	--	NS	--	--	NS	--	--	NS	--	--
NITROGEN, NITRATE-NITRITE	NS	--	--	NS	--	--	NS	--	--	NS	--	--	

Table 13
Analytical Data Table for KAFB-106MW1-S

Phase Designation		Phase 1 Recirculation											
Sample ID		106MW1S-P1R-100917			106MW1S-P1R-101217			106MW1S-P1R-101617			106MW1S-P1R-102017		
Sample Date		10/9/2017			10/12/2017			10/16/2017			10/20/2017		
Sample Purpose		REG			REG			REG			REG		
Chemical Class and Analytical Method ^a	Parameter	Result	Val Qual	LOQ	Result	Val Qual	LOQ	Result	Val Qual	LOQ	Result	Val Qual	LOQ
General Chemistry (mg/L) SM2320b, EPA Method 300, EPA Method 353.2, SM4500 Pec	O-PHOSPHATE (AS P)	NS	--	--	NS	--	--	NS	--	--	NS	--	--
	ORTHOPHOSPHATE	NS	--	--	NS	--	--	NS	--	--	NS	--	--
	PHOSPHORUS	NS	--	--	NS	--	--	NS	--	--	NS	--	--
	SULFATE	NS	--	--	NS	--	--	NS	--	--	NS	--	--
Metals (mg/L) EPA Method 6010	LEAD	NS	--	--	NS	--	--	NS	--	--	NS	--	--
Dissolved Metals (mg/L) EPA Method 6010	IRON	NS	--	--	NS	--	--	NS	--	--	NS	--	--
	MANGANESE	NS	--	--	NS	--	--	NS	--	--	NS	--	--
δ2H (‰) Mass Spectrometry, USGS Reston, VA	DELTA2H	-95.69		-99	-31.49		-99	-55.24		-99	-83.98		-99
CSIA EDB δ13C (‰) Kuder et al, 2012	EDB δ	NS	--	--	NS	--	--	NS	--	--	NS	--	--
VOCs (µg/L) EPA Method 8260	1,1,2-TRICHLOROETHANE	NS	--	--	NS	--	--	NS	--	--	NS	--	--
	1,2,4-TRICHLOROBENZENE	NS	--	--	NS	--	--	NS	--	--	NS	--	--
	1,2,4-TRIMETHYLBENZENE	NS	--	--	NS	--	--	NS	--	--	NS	--	--
	1,2-DIBROMOETHANE	NS	--	--	NS	--	--	NS	--	--	NS	--	--
	1,2-DICHLOROETHANE	NS	--	--	NS	--	--	NS	--	--	NS	--	--
	1,3,5-TRIMETHYLBENZENE	NS	--	--	NS	--	--	NS	--	--	NS	--	--
	2-BUTANONE	NS	--	--	NS	--	--	NS	--	--	NS	--	--
	2-CHLOROTOLUENE	NS	--	--	NS	--	--	NS	--	--	NS	--	--
	2-HEXANONE	NS	--	--	NS	--	--	NS	--	--	NS	--	--
	4-METHYL-2-PENTANONE	NS	--	--	NS	--	--	NS	--	--	NS	--	--
	ACETONE	NS	--	--	NS	--	--	NS	--	--	NS	--	--
	BENZENE	NS	--	--	NS	--	--	NS	--	--	NS	--	--
	CARBON DISULFIDE	NS	--	--	NS	--	--	NS	--	--	NS	--	--
	CHLOROMETHANE	NS	--	--	NS	--	--	NS	--	--	NS	--	--
	CIS-1,2-DICHLOROETHENE	NS	--	--	NS	--	--	NS	--	--	NS	--	--
	DICHLORODIFLUOROMETHANE	NS	--	--	NS	--	--	NS	--	--	NS	--	--
	ETHYLBENZENE	NS	--	--	NS	--	--	NS	--	--	NS	--	--
	ISOPROPYLBENZENE	NS	--	--	NS	--	--	NS	--	--	NS	--	--
	M,P-XYLENES	NS	--	--	NS	--	--	NS	--	--	NS	--	--
	METHYL TERT-BUTYL ETHER	NS	--	--	NS	--	--	NS	--	--	NS	--	--
	METHYLENE CHLORIDE	NS	--	--	NS	--	--	NS	--	--	NS	--	--
	NAPHTHALENE	NS	--	--	NS	--	--	NS	--	--	NS	--	--
	N-BUTYLBENZENE	NS	--	--	NS	--	--	NS	--	--	NS	--	--
	N-PROPYLBENZENE	NS	--	--	NS	--	--	NS	--	--	NS	--	--
	O-XYLENE	NS	--	--	NS	--	--	NS	--	--	NS	--	--
	P-ISOPROPYLTOLUENE	NS	--	--	NS	--	--	NS	--	--	NS	--	--
	SEC-BUTYLBENZENE	NS	--	--	NS	--	--	NS	--	--	NS	--	--
	TERT-BUTYLBENZENE	NS	--	--	NS	--	--	NS	--	--	NS	--	--
TETRACHLOROETHENE	NS	--	--	NS	--	--	NS	--	--	NS	--	--	
TOLUENE	NS	--	--	NS	--	--	NS	--	--	NS	--	--	
TRANS-1,2-DICHLOROETHENE	NS	--	--	NS	--	--	NS	--	--	NS	--	--	
TRICHLOROETHENE	NS	--	--	NS	--	--	NS	--	--	NS	--	--	
TRICHLOROFUOROMETHANE	NS	--	--	NS	--	--	NS	--	--	NS	--	--	
VINYL CHLORIDE	NS	--	--	NS	--	--	NS	--	--	NS	--	--	
XYLENES	NS	--	--	NS	--	--	NS	--	--	NS	--	--	

Refer to notes at the end of the table.

Table 13
Analytical Data Table for KAFB-106MW1-S

Phase Designation		Phase 1 Recirculation						Phase 1 Passive					
Sample ID		106MW1S-P1R-102417			106MW1S-P1R-110117			106MW1S-P1P-111517			106MW1S-P1P-112817		
Sample Date		10/24/2017			11/1/2017			11/15/2017			11/28/2017		
Sample Purpose		REG			REG			REG			REG		
Chemical Class and Analytical Method ^a	Parameter	Result	Val Qual	LOQ	Result	Val Qual	LOQ	Result	Val Qual	LOQ	Result	Val Qual	LOQ
Microbial Community (cells/mL) QuantArray-Chlor	1,1 DCA Reductase (DCA)	NS	--	--	NS	--	--	NS	--	--	ND	U	4.8
	1,2 DCA Reductase (DCAR)	NS	--	--	NS	--	--	NS	--	--	ND	U	4.8
	BAV1 Vinyl Chloride Reductase (BVC)	NS	--	--	NS	--	--	NS	--	--	ND	U	0.5
	cer A Reductase	NS	--	--	NS	--	--	NS	--	--	NA	--	--
	Chloroform Reductase (CFR)	NS	--	--	NS	--	--	NS	--	--	ND	U	4.8
	Dehalobacter DCM (DCM)	NS	--	--	NS	--	--	NS	--	--	ND	U	4.8
	Dehalobacter spp. (DHBt)	NS	--	--	NS	--	--	NS	--	--	252000		4.8
	Dehalobium chlorocoercia (DECO)	NS	--	--	NS	--	--	NS	--	--	11200		4.8
	Dehalococcoides (DHC)	NS	--	--	NS	--	--	NS	--	--	ND	U	0.5
	Dehalogenimonas spp. (DHG)	NS	--	--	NS	--	--	NS	--	--	ND	U	4.8
	Desulfitobacterium spp. (DSB)	NS	--	--	NS	--	--	NS	--	--	1400000		4.8
	Desulfuromonas spp. (DSM)	NS	--	--	NS	--	--	NS	--	--	ND	U	4.8
	Dichloromethane Dehalogenase (DCMA)	NS	--	--	NS	--	--	NS	--	--	ND	U	4.8
	Epoxyalkane Transferase (EtnE)	NS	--	--	NS	--	--	NS	--	--	71.4		4.8
	Ethene Monooxygenase (EtnC)	NS	--	--	NS	--	--	NS	--	--	ND	U	4.8
	Methanogens (MGN)	NS	--	--	NS	--	--	NS	--	--	22100		4.8
	PCE Reductase (PCE-1)	NS	--	--	NS	--	--	NS	--	--	NA	--	--
	Phenol Hydroxylase (PHE)	NS	--	--	NS	--	--	NS	--	--	18400		4.8
	PMMO	NS	--	--	NS	--	--	NS	--	--	ND	U	4.8
	Soluble Methane Monooxygenase (SMMO)	NS	--	--	NS	--	--	NS	--	--	2640		4.8
	Sulfate Reducing Bacteria (APS)	NS	--	--	NS	--	--	NS	--	--	192000		4.8
	tceA Reductase (TCE)	NS	--	--	NS	--	--	NS	--	--	ND	U	0.5
	Toluene Dioxygenase (TOD)	NS	--	--	NS	--	--	NS	--	--	ND	U	4.8
Toluene Monooxygenase (RMO)	NS	--	--	NS	--	--	NS	--	--	175000		4.8	
Toluene Monooxygenase 2 (RDEG)	NS	--	--	NS	--	--	NS	--	--	61400		4.8	
Total Eubacteria (EBAC)	NS	--	--	NS	--	--	NS	--	--	14200000		4.8	
trans-1,2-DCE Reductase (TDR)	NS	--	--	NS	--	--	NS	--	--	NA	--	--	
Trichlorobenzene Dioxygenase (TCBO)	NS	--	--	NS	--	--	NS	--	--	ND	U	4.8	
Vinyl Chloride Reductase (VCR)	NS	--	--	NS	--	--	NS	--	--	ND	U	0.5	
EDB (µg/L) EPA Method 8011	1,2-DIBROMOETHANE	104		9.67	NS	--	--	108		3.78	47.8		3.81
VFAs (mg/L) EPA Method 300m	ACETIC ACID	0.72	J	1	NS	--	--	3.23		1	3.77		1
	BUTYRIC ACID	ND	U	1	NS	--	--	ND	U	1	ND	U	1
	FORMIC ACID	ND	U	1	NS	--	--	ND	U	1	ND	U	1
	LACTIC ACID	ND	U	1	NS	--	--	ND	U	1	ND	U	1
	PROPIONIC ACID	ND	U	1	NS	--	--	ND	U	1	ND	U	1
	PYRUVIC ACID	ND	U	1	NS	--	--	ND	U	1	ND	U	1
VALERIC ACID	ND	U	1	NS	--	--	ND	U	1	ND	U	1	
Fluorometric (µg/L) Spectrofluorophotometry	FLUORESC EIN	6.306		0.01	6.629		0.01	7.462		0.01	4.108		0.01
Reduced Gases (µg/L) RSKSOP-175	ACETYLENE	ND	U	10	NS	--	--	ND	U	10	ND	U	10
	ETHANE	ND	U	4	NS	--	--	ND	U	4	ND	U	4
	ETHYLENE	3.07	J	5	NS	--	--	ND	U	5	ND	U	5
	METHANE	1.01	J	2	NS	--	--	ND	U	2	ND	U	2
	PROPANE	ND	U	6	NS	--	--	ND	U	6	ND	U	6
General Chemistry (mg/L) SM2320b, EPA Method 300, EPA Method 353.2, SM4500 PE ^c	ALKALINITY	337		1	NS	--	--	327		1	319		1
	BROMIDE	0.466		0.125	NS	--	--	0.571		0.125	0.631		0.25
	CHLORIDE	39.7		0.33	NS	--	--	44		0.33	45.2		0.66
	IODIDE	ND	U	0.75	NS	--	--	ND	U	0.75	ND	U	0.75
	NITRATE	NA	--	--	NS	--	--	NA	--	--	NA	--	--
	NITRITE	NA	--	--	NS	--	--	NA	--	--	NA	--	--
NITROGEN, NITRATE-NITRITE	ND	U	0.375	NS	--	--	ND	U	0.375	ND	U	0.375	

Table 13
Analytical Data Table for KAFB-106MW1-S

Phase Designation		Phase 1 Recirculation						Phase 1 Passive					
Sample ID		106MW1S-P1R-102417			106MW1S-P1R-110117			106MW1S-P1P-111517			106MW1S-P1P-112817		
Sample Date		10/24/2017			11/1/2017			11/15/2017			11/28/2017		
Sample Purpose		REG			REG			REG			REG		
Chemical Class and Analytical Method ^a	Parameter	Result	Val Qual	LOQ	Result	Val Qual	LOQ	Result	Val Qual	LOQ	Result	Val Qual	LOQ
General Chemistry (mg/L) SM2320b, EPA Method 300, EPA Method 353.2, SM4500 Pec	O-PHOSPHATE (AS P)	ND	U	0.02	NS	--	--	0.0171	J	0.02	ND	U	0.02
	ORTHOPHOSPHATE	NA	--	--	NS	--	--	NA	--	--	NA	--	--
	PHOSPHORUS	NA	--	--	NS	--	--	NA	--	--	NA	--	--
	SULFATE	19.1		1	NS	--	--	3.35		1	0.804	J	2
Metals (mg/L) EPA Method 6010	LEAD	NS	--	--	NS	--	--	NS	--	--	NS	--	--
Dissolved Metals (mg/L) EPA Method 6010	IRON	0.497		0.06	NS	--	--	1.38		0.06	2.72		0.06
	MANGANESE	2.28		0.006	NS	--	--	2.68		0.006	2.87		0.006
δ2H (‰) Mass Spectrometry, USGS Reston, VA	DELTA2H	-89.2		-99	-88.68		-99	-88.7		-99	-89.43		-99
CSIA EDB δ13C (‰) Kuder et al, 2012	EDB δ	NS	--	--	NS	--	--	NS	--	--	-18.2 ±2‰	--	--
VOCs (µg/L) EPA Method 8260	1,1,2-TRICHLOROETHANE	ND	U	50	NS	--	--	ND	U	50	ND	U	100
	1,2,4-TRICHLOROBENZENE	NA	--	--	NS	--	--	NA	--	--	NA	--	--
	1,2,4-TRIMETHYLBENZENE	386		50	NS	--	--	305		50	362		100
	1,2-DIBROMOETHANE	130		50	NS	--	--	115		50	53.6	J	100
	1,2-DICHLOROETHANE	ND	U	50	NS	--	--	ND	U	50	ND	U	100
	1,3,5-TRIMETHYLBENZENE	129		50	NS	--	--	114		50	139	J	100
	2-BUTANONE	ND	U	500	NS	--	--	ND	U	500	ND	U	1000
	2-CHLOROTOLUENE	ND	U	50	NS	--	--	ND	U	50	ND	U	100
	2-HEXANONE	243	J	250	NS	--	--	202	J	250	ND	U	500
	4-METHYL-2-PENTANONE	166	J	250	NS	--	--	138	J	250	ND	U	500
	ACETONE	ND	U	500	NS	--	--	305	J	500	ND	U	1000
	BENZENE	3630		50	NS	--	--	4720		50	3800		100
	CARBON DISULFIDE	ND	U	50	NS	--	--	ND	U	50	ND	U	100
	CHLOROMETHANE	ND	U	50	NS	--	--	ND	U	50	ND	U	100
	CIS-1,2-DICHLOROETHENE	NA	--	--	NS	--	--	NA	--	--	NA	--	--
	DICHLORODIFLUOROMETHANE	ND	U	100	NS	--	--	ND	U	100	ND	U	200
	ETHYLBENZENE	1130		50	NS	--	--	1120		50	1100		100
	ISOPROPYLBENZENE	93.2	J	50	NS	--	--	84.4	J	50	92.6	J	100
	M,P-XYLENES	NA	--	--	NS	--	--	NA	--	--	NA	--	--
	METHYL TERT-BUTYL ETHER	ND	U	50	NS	--	--	ND	U	50	ND	U	100
	METHYLENE CHLORIDE	ND	U	100	NS	--	--	ND	U	100	ND	U	200
	NAPHTHALENE	130		50	NS	--	--	139		50	115	J	100
	N-BUTYLBENZENE	ND	U	50	NS	--	--	ND	U	50	ND	U	100
	N-PROPYLBENZENE	92.9	J	50	NS	--	--	88.4	J	50	95.4	J	100
	O-XYLENE	NA	--	--	NS	--	--	NA	--	--	NA	--	--
	P-ISOPROPYLTOLUENE	ND	U	50	NS	--	--	ND	U	50	ND	U	100
	SEC-BUTYLBENZENE	ND	U	50	NS	--	--	ND	U	50	ND	U	100
	TERT-BUTYLBENZENE	ND	U	50	NS	--	--	ND	U	50	ND	U	100
	TETRACHLOROETHENE	NA	--	--	NS	--	--	NA	--	--	NA	--	--
	TOLUENE	9330		50	NS	--	--	11700		50	11100		100
	TRANS-1,2-DICHLOROETHENE	NA	--	--	NS	--	--	NA	--	--	NA	--	--
	TRICHLOROETHENE	ND	U	50	NS	--	--	ND	U	50	ND	U	100
TRICHLOROFUOROMETHANE	ND	U	100	NS	--	--	ND	U	100	ND	U	200	
VINYL CHLORIDE	NA	--	--	NS	--	--	NA	--	--	NA	--	--	
XYLENES	4380		150	NS	--	--	3910		150	4060		300	

Refer to notes at the end of the table.

Table 13
Analytical Data Table for KAFB-106MW1-S

Phase Designation		Phase 2 Recirculation									Phase 2 Passive		
Sample ID		106MW1S-P2R-010918			106MW1S-P2R-011818			106MW1S-P2R-012418			106MW1S-P2P-030618		
Sample Date		1/9/2018			1/18/2018			1/24/2018			3/6/2018		
Sample Purpose		REG			REG			REG			REG		
Chemical Class and Analytical Method ^a	Parameter	Result	Val Qual	LOQ	Result	Val Qual	LOQ	Result	Val Qual	LOQ	Result	Val Qual	LOQ
Microbial Community (cells/mL) QuantArray-Chlor	1,1 DCA Reductase (DCA)	NS	--	--	NS	--	--	ND	U	5.3	NS	--	--
	1,2 DCA Reductase (DCAR)	NS	--	--	NS	--	--	ND	U	5.3	NS	--	--
	BAV1 Vinyl Chloride Reductase (BVC)	NS	--	--	NS	--	--	ND	U	0.5	NS	--	--
	cer A Reductase	NS	--	--	NS	--	--	ND	U	5.3	NS	--	--
	Chloroform Reductase (CFR)	NS	--	--	NS	--	--	ND	U	5.3	NS	--	--
	Dehalobacter DCM (DCM)	NS	--	--	NS	--	--	ND	U	5.3	NS	--	--
	Dehalobacter spp. (DHBt)	NS	--	--	NS	--	--	61700		5.3	NS	--	--
	Dehalobium chlorocoercia (DECO)	NS	--	--	NS	--	--	12400		5.3	NS	--	--
	Dehalococcoides (DHC)	NS	--	--	NS	--	--	ND	U	0.5	NS	--	--
	Dehalogenimonas spp. (DHG)	NS	--	--	NS	--	--	345		5.3	NS	--	--
	Desulfitobacterium spp. (DSB)	NS	--	--	NS	--	--	82500		5.3	NS	--	--
	Desulfuromonas spp. (DSM)	NS	--	--	NS	--	--	ND	U	5.3	NS	--	--
	Dichloromethane Dehalogenase (DCMA)	NS	--	--	NS	--	--	ND	U	5.3	NS	--	--
	Epoxyalkane Transferase (EtnE)	NS	--	--	NS	--	--	ND	U	5.3	NS	--	--
	Ethene Monooxygenase (EtnC)	NS	--	--	NS	--	--	ND	U	5.3	NS	--	--
	Methanogens (MGN)	NS	--	--	NS	--	--	6.1		5.3	NS	--	--
	PCE Reductase (PCE-1)	NS	--	--	NS	--	--	0.5	J	5.3	NS	--	--
	Phenol Hydroxylase (PHE)	NS	--	--	NS	--	--	34600		5.3	NS	--	--
	PMMO	NS	--	--	NS	--	--	NA	--	--	NS	--	--
	Soluble Methane Monooxygenase (SMMO)	NS	--	--	NS	--	--	290		5.3	NS	--	--
Sulfate Reducing Bacteria (APS)	NS	--	--	NS	--	--	161000		5.3	NS	--	--	
tceA Reductase (TCE)	NS	--	--	NS	--	--	ND	U	0.5	NS	--	--	
Toluene Dioxygenase (TOD)	NS	--	--	NS	--	--	ND	U	5.3	NS	--	--	
Toluene Monooxygenase (RMO)	NS	--	--	NS	--	--	34400		5.3	NS	--	--	
Toluene Monooxygenase 2 (RDEG)	NS	--	--	NS	--	--	20100		5.3	NS	--	--	
Total Eubacteria (EBAC)	NS	--	--	NS	--	--	4230000		5.3	NS	--	--	
trans-1,2-DCE Reductase (TDR)	NS	--	--	NS	--	--	ND	U	5.3	NS	--	--	
Trichlorobenzene Dioxygenase (TCBO)	NS	--	--	NS	--	--	ND	U	5.3	NS	--	--	
Vinyl Chloride Reductase (VCR)	NS	--	--	NS	--	--	ND	U	0.5	NS	--	--	
EDB (µg/L) EPA Method 8011	1,2-DIBROMOETHANE	63.5		1.89	104	J	1.9	66.4		1.89	92.5	J+	9.49
VFAs (mg/L) EPA Method 300m	ACETIC ACID	60.4		1	67.5		1	91.5		1	71.6		10
	BUTYRIC ACID	ND	U	1	0.51	J	1	1.21		1	1.2		1
	FORMIC ACID	ND	U	1	ND	U	1	ND	U	1	ND	U	1
	LACTIC ACID	1.61		1	1.35		1	1.93		1	1		1
	PROPIONIC ACID	25.5		1	19.4		1	26		1	22.1		1
	PYRUVIC ACID	ND	U	1	ND	U	1	ND	U	1	ND	U	1
VALERIC ACID	ND	U	1	ND	U	1	ND	U	1	ND	U	1	
Fluorometric (µg/L) Spectrofluorophotometry	FLUORESC EIN												
Reduced Gases (µg/L) RSKSOP-175	ACETYLENE	ND	U	10	ND	U	10	ND	U	10	ND	U	10
	ETHANE	1.64	J	4	1.63	J	4	2.22	J	4	3.85	J	4
	ETHYLENE	6.25		5	6.2		5	7.84		5	11.57		5
	METHANE	1.92	J	2	2.13		2	3.46		2	19.3		2
	PROPANE	1.86	J	6	2.07	J	6	2.68	J	6	5.39	J	6
General Chemistry (mg/L) SM2320b, EPA Method 300, EPA Method 353.2, SM4500 PE ^c	ALKALINITY	308		1	303		1	368		1	423		1
	BROMIDE	0.469	J	0.25	0.294		0.125	0.49	J	0.25	0.532	J	0.625
	CHLORIDE	49.4		0.66	21.9		0.33	45.8		0.66	48.4		1.65
	IODIDE	8.7		0.75	9.7		0.75	11		0.75	14		0.75
	NITRATE	NA	--	--	NA	--	--	NA	--	--	NA	--	--
	NITRITE	NA	--	--	NA	--	--	NA	--	--	NA	--	--
NITROGEN, NITRATE-NITRITE	ND	U	0.375	ND	U	0.375	ND	U	0.375	ND	U	0.375	

Table 13
Analytical Data Table for KAFB-106MW1-S

Phase Designation		Phase 2 Recirculation									Phase 2 Passive		
Sample ID		106MW1S-P2R-010918			106MW1S-P2R-011818			106MW1S-P2R-012418			106MW1S-P2P-030618		
Sample Date		1/9/2018			1/18/2018			1/24/2018			3/6/2018		
Sample Purpose		REG			REG			REG			REG		
Chemical Class and Analytical Method ^a	Parameter	Result	Val Qual	LOQ	Result	Val Qual	LOQ	Result	Val Qual	LOQ	Result	Val Qual	LOQ
General Chemistry (mg/L) SM2320b, EPA Method 300, EPA Method 353.2, SM4500 Pec	O-PHOSPHATE (AS P)	ND	U	0.02	0.0154	J	0.02	ND	U	0.02	ND	U	0.02
	ORTHOPHOSPHATE	NA	--	--	NA	--	--	NA	--	--	NA	--	--
	PHOSPHORUS	NA	--	--	NA	--	--	NA	--	--	NA	--	--
	SULFATE	1.44	J	2	5.56	J+	1	0.698	J	2	ND	U	5
Metals (mg/L) EPA Method 6010	LEAD	NS	--	--	NS	--	--	NS	--	--	NS	--	--
Dissolved Metals (mg/L) EPA Method 6010	IRON	1.62		0.06	0.186		0.06	2.24	J-	0.06	5.9		0.06
	MANGANESE	3.22		0.006	0.413		0.006	3.48	J-	0.006	4.84		0.006
δ2H (‰) Mass Spectrometry, USGS Reston, VA	DELTA2H	NS	--	--	NS	--	--	NS	--	--	NS	--	--
CSIA EDB δ13C (‰) Kuder et al, 2012	EDB δ	NS	--	--	NS	--	--	-11.7 ±2‰	--	--	NS	--	--
VOCs (µg/L) EPA Method 8260	1,1,2-TRICHLOROETHANE	ND	U	25	ND	U	50	ND	U	50	ND	U	100
	1,2,4-TRICHLOROBENZENE	NA	--	--	NA	--	--	NA	--	--	NA	--	--
	1,2,4-TRIMETHYLBENZENE	441		25	305		50	416		50	419		100
	1,2-DIBROMOETHANE	78.7		25	59.7	J	50	56.5	J	50	128	J	100
	1,2-DICHLOROETHANE	ND	U	25	ND	U	50	ND	U	50	ND	U	100
	1,3,5-TRIMETHYLBENZENE	144		25	106		50	136		50	141	J	100
	2-BUTANONE	ND	U	250	ND	U	500	ND	U	500	ND	U	1000
	2-CHLOROTOLUENE	ND	U	25	ND	U	50	ND	U	50	ND	U	100
	2-HEXANONE	145	J	125	129	J	250	ND	U	250	ND	U	500
	4-METHYL-2-PENTANONE	102	J	125	ND	U	250	ND	U	250	ND	U	500
	ACETONE	326	J	250	585	J	500	292	J	500	ND	U	1000
	BENZENE	3470		25	3530		50	3490		50	8100		100
	CARBON DISULFIDE	ND	U	25	ND	U	50	ND	U	50	ND	U	100
	CHLOROMETHANE	ND	U	25	ND	U	50	ND	U	50	ND	U	100
	CIS-1,2-DICHLOROETHENE	NA	--	--	NA	--	--	NA	--	--	NA	--	--
	DICHLORODIFLUOROMETHANE	ND	U	50	ND	U	100	ND	U	100	ND	U	200
	ETHYLBENZENE	1150		25	974		50	1110		50	1360		100
	ISOPROPYLBENZENE	95.7		25	85	J	50	89.5	J	50	87.6	J	100
	M,P-XYLENES	NA	--	--	NA	--	--	NA	--	--	NA	--	--
	METHYL TERT-BUTYL ETHER	ND	U	25	ND	U	50	ND	U	50	ND	U	100
	METHYLENE CHLORIDE	ND	U	50	ND	U	100	ND	U	100	ND	U	200
	NAPHTHALENE	135		25	136		50	102		50	122	J	100
	N-BUTYLBENZENE	22.3	J	25	ND	U	50	ND	U	50	ND	U	100
	N-PROPYLBENZENE	109		25	97.8	J	50	103		50	109	J	100
	O-XYLENE	NA	--	--	NA	--	--	NA	--	--	NA	--	--
	P-ISOPROPYLTOLUENE	38.2	J	25	41.8	J	50	ND	U	50	ND	U	100
	SEC-BUTYLBENZENE	18.6	J	25	ND	U	50	ND	U	50	ND	U	100
	TERT-BUTYLBENZENE	ND	U	25	ND	U	50	ND	U	50	ND	U	100
	TETRACHLOROETHENE	NA	--	--	NA	--	--	NA	--	--	NA	--	--
	TOLUENE	8310		25	8480		50	9110		50	16000		100
	TRANS-1,2-DICHLOROETHENE	NA	--	--	NA	--	--	NA	--	--	NA	--	--
	TRICHLOROETHENE	ND	U	25	ND	U	50	ND	U	50	ND	U	100
TRICHLOROFUOROMETHANE	ND	U	50	ND	U	100	ND	U	100	ND	U	200	
VINYL CHLORIDE	NA	--	--	NA	--	--	NA	--	--	NA	--	--	
XYLENES	3380		75	3250		150	3710		150	4420		300	

Refer to notes at the end of the table.

Table 13
Analytical Data Table for KAFB-106MW1-S

Phase Designation		Phase 2 Passive									Phase 3 Recirculation		
Sample ID		106MW1S-P2P-041118			106MW1S-P2P-050818			106MW1S-P2P-061418			106MW1S-P3R-080718		
Sample Date		4/11/2018			5/8/2018			6/14/2018			8/7/2018		
Sample Purpose		REG			REG			REG			REG		
Chemical Class and Analytical Method ^a	Parameter	Result	Val Qual	LOQ	Result	Val Qual	LOQ	Result	Val Qual	LOQ	Result	Val Qual	LOQ
Microbial Community (cells/mL) QuantArray-Chlor	1,1 DCA Reductase (DCA)	NS	--	--	ND	U	6.3	NS	--	--	NS	--	--
	1,2 DCA Reductase (DCAR)	NS	--	--	ND	U	6.3	NS	--	--	NS	--	--
	BAV1 Vinyl Chloride Reductase (BVC)	NS	--	--	ND	U	0.6	NS	--	--	NS	--	--
	cer A Reductase	NS	--	--	ND	U	6.3	NS	--	--	NS	--	--
	Chloroform Reductase (CFR)	NS	--	--	ND	U	6.3	NS	--	--	NS	--	--
	Dehalobacter DCM (DCM)	NS	--	--	6950		6.3	NS	--	--	NS	--	--
	Dehalobacter spp. (DHBt)	NS	--	--	70500		6.3	NS	--	--	NS	--	--
	Dehalobium chlorocoercia (DECO)	NS	--	--	5300		6.3	NS	--	--	NS	--	--
	Dehalococcoides (DHC)	NS	--	--	ND	U	0.6	NS	--	--	NS	--	--
	Dehalogenimonas spp. (DHG)	NS	--	--	276		6.3	NS	--	--	NS	--	--
	Desulfitobacterium spp. (DSB)	NS	--	--	20700		6.3	NS	--	--	NS	--	--
	Desulfuromonas spp. (DSM)	NS	--	--	50.6		6.3	NS	--	--	NS	--	--
	Dichloromethane Dehalogenase (DCMA)	NS	--	--	ND	U	6.3	NS	--	--	NS	--	--
	Epoxyalkane Transferase (EtnE)	NS	--	--	ND	U	6.3	NS	--	--	NS	--	--
	Ethene Monooxygenase (EtnC)	NS	--	--	ND	U	6.3	NS	--	--	NS	--	--
	Methanogens (MGN)	NS	--	--	189		6.3	NS	--	--	NS	--	--
	PCE Reductase (PCE-1)	NS	--	--	0.1	J	6.3	NS	--	--	NS	--	--
	Phenol Hydroxylase (PHE)	NS	--	--	25000		6.3	NS	--	--	NS	--	--
	PMMO	NS	--	--	NA	--	--	NS	--	--	NS	--	--
	Soluble Methane Monooxygenase (SMMO)	NS	--	--	676		6.3	NS	--	--	NS	--	--
Sulfate Reducing Bacteria (APS)	NS	--	--	16800		6.3	NS	--	--	NS	--	--	
tceA Reductase (TCE)	NS	--	--	ND	U	0.6	NS	--	--	NS	--	--	
Toluene Dioxygenase (TOD)	NS	--	--	ND	U	6.3	NS	--	--	NS	--	--	
Toluene Monooxygenase (RMO)	NS	--	--	44300		6.3	NS	--	--	NS	--	--	
Toluene Monooxygenase 2 (RDEG)	NS	--	--	16100		6.3	NS	--	--	NS	--	--	
Total Eubacteria (EBAC)	NS	--	--	6470000		6.3	NS	--	--	NS	--	--	
trans-1,2-DCE Reductase (TDR)	NS	--	--	ND	U	6.3	NS	--	--	NS	--	--	
Trichlorobenzene Dioxygenase (TCBO)	NS	--	--	304		6.3	NS	--	--	NS	--	--	
Vinyl Chloride Reductase (VCR)	NS	--	--	ND	U	0.6	NS	--	--	NS	--	--	
EDB (µg/L) EPA Method 8011	1,2-DIBROMOETHANE	85.5	J	1.92	24.7		0.958	12.2		0.474	NA	--	--
VFAs (mg/L) EPA Method 300m	ACETIC ACID	81.3		20	90.3		20	83.3	J	10	85.5		10
	BUTYRIC ACID	ND	U	1	ND	U	1	ND	UJ	10	ND	U	1
	FORMIC ACID	2.4		1	0.2	J	1	ND	UJ	10	4.7	J	10
	LACTIC ACID	1.06		1	ND	U	1	ND	UJ	10	ND	U	1
	PROPIONIC ACID	16.3		20	12.3		1	ND	UJ	10	ND	U	1
	PYRUVIC ACID	ND	U	1	ND	U	1	ND	UJ	10	ND	U	1
VALERIC ACID	ND	U	1	ND	U	1	ND	UJ	10	ND	U	1	
Fluorometric (µg/L) Spectrofluorophotometry	FLUORESCEIN												
Reduced Gases (µg/L) RSKSOP-175	ACETYLENE	ND	U	10	ND	U	10	ND	UJ	10	ND	U	10
	ETHANE	4.7		4	5.65		4	6.3	J	4	4.7		4
	ETHYLENE	18.57		5	14.46		5	13.4	J	5	12.4		5
	METHANE	25.4		2	25.37		2	24.7	J	2	17.9		2
	PROPANE	8.1		6	12.07		6	8.9	J	6	7.1		6
General Chemistry (mg/L) SM2320b, EPA Method 300, EPA Method 353.2, SM4500 PE ^c	ALKALINITY	441		1	454		1	494	J-	1	NA	--	--
	BROMIDE	0.659		0.25	0.522	J-	0.625	0.457	J	0.625	NA	--	--
	CHLORIDE	50.8		0.66	50		1.65	50.6		1.65	NA	--	--
	IODIDE	14		0.75	16		0.75	13		0.75	15		0.75
	NITRATE	ND	U	0.2	ND	U	0.5	ND	U	0.5	NA	--	--
	NITRITE	ND	U	0.2	ND	U	0.5	ND	U	0.5	NA	--	--
NITROGEN, NITRATE-NITRITE	NA	--	--	NA	--	--	NA	--	--	NA	--	--	

Table 13
Analytical Data Table for KAFB-106MW1-S

Phase Designation		Phase 2 Passive									Phase 3 Recirculation		
Sample ID		106MW1S-P2P-041118			106MW1S-P2P-050818			106MW1S-P2P-061418			106MW1S-P3R-080718		
Sample Date		4/11/2018			5/8/2018			6/14/2018			8/7/2018		
Sample Purpose		REG			REG			REG			REG		
Chemical Class and Analytical Method ^a	Parameter	Result	Val Qual	LOQ	Result	Val Qual	LOQ	Result	Val Qual	LOQ	Result	Val Qual	LOQ
General Chemistry (mg/L) SM2320b, EPA Method 300, EPA Method 353.2, SM4500 Pec	O-PHOSPHATE (AS P)	ND	U	0.02	ND	U	0.02	ND	U	0.02	NA	--	--
	ORTHOPHOSPHATE	NA	--	--	NA	--	--	NA	--	--	NA	--	--
	PHOSPHORUS	NA	--	--	NA	--	--	NA	--	--	NA	--	--
	SULFATE	ND	U	2	ND	U	5	ND	U	5	NA	--	--
Metals (mg/L) EPA Method 6010	LEAD	NS	--	--	NS	--	--	NS	--	--	NS	--	--
Dissolved Metals (mg/L) EPA Method 6010	IRON	5.91	J-	0.06	8.18		0.06	8.07		0.06	NA	--	--
	MANGANESE	5.35	J+	0.006	5.96		0.006	5.73		0.006	NA	--	--
δ2H (‰) Mass Spectrometry, USGS Reston, VA	DELTA2H	NS	--	--	NS	--	--	NS	--	--	NS	--	--
CSIA EDB δ13C (‰) Kuder et al, 2012	EDB δ	NS	--	--	-9.6 ±1‰	--	--	NS	--	--	NS	--	--
VOCs (µg/L) EPA Method 8260	1,1,2-TRICHLOROETHANE	ND	U	125	ND	U	100	ND	U	100	NA	--	--
	1,2,4-TRICHLOROBENZENE	NA	--	--	NA	--	--	NA	--	--	NA	--	--
	1,2,4-TRIMETHYLBENZENE	426		125	470		100	404		100	NA	--	--
	1,2-DIBROMOETHANE	62.9	J	125	ND	U	100	ND	U	100	NA	--	--
	1,2-DICHLOROETHANE	ND	U	125	ND	U	100	ND	U	100	NA	--	--
	1,3,5-TRIMETHYLBENZENE	162	J	125	159	J	100	143	J	100	NA	--	--
	2-BUTANONE	ND	U	1250	ND	U	1000	ND	U	1000	NA	--	--
	2-CHLOROTOLUENE	ND	U	125	ND	U	100	ND	U	100	NA	--	--
	2-HEXANONE	ND	U	625	ND	U	500	ND	U	500	NA	--	--
	4-METHYL-2-PENTANONE	ND	U	625	ND	U	500	ND	U	500	NA	--	--
	ACETONE	ND	U	1250	ND	U	1000	ND	U	1000	NA	--	--
	BENZENE	8920		125	6100		100	4190		100	NA	--	--
	CARBON DISULFIDE	ND	U	125	ND	U	100	ND	U	100	NA	--	--
	CHLOROMETHANE	ND	U	125	ND	U	100	ND	U	100	NA	--	--
	CIS-1,2-DICHLOROETHENE	NA	--	--	NA	--	--	NA	--	--	NA	--	--
	DICHLORODIFLUOROMETHANE	ND	U	250	ND	U	200	ND	U	200	NA	--	--
	ETHYLBENZENE	1360		125	1560		100	1300		100	NA	--	--
	ISOPROPYLBENZENE	114	J	125	113	J	100	108	J	100	NA	--	--
	M,P-XYLENES	NA	--	--	NA	--	--	NA	--	--	NA	--	--
	METHYL TERT-BUTYL ETHER	ND	U	125	ND	U	100	ND	U	100	NA	--	--
	METHYLENE CHLORIDE	ND	U	250	ND	U	200	ND	U	200	NA	--	--
	NAPHTHALENE	147	J	125	153	J	100	139	J	100	NA	--	--
	N-BUTYLBENZENE	ND	U	125	ND	U	100	ND	U	100	NA	--	--
	N-PROPYLBENZENE	116	J	125	118	J	100	101	J	100	NA	--	--
	O-XYLENE	NA	--	--	NA	--	--	NA	--	--	NA	--	--
	P-ISOPROPYLTOLUENE	130	J	125	ND	U	100	ND	U	100	NA	--	--
	SEC-BUTYLBENZENE	ND	U	125	ND	U	100	ND	U	100	NA	--	--
	TERT-BUTYLBENZENE	ND	U	125	ND	U	100	ND	U	100	NA	--	--
	TETRACHLOROETHENE	NA	--	--	NA	--	--	NA	--	--	NA	--	--
	TOLUENE	14900		125	16700		100	11000		100	NA	--	--
	TRANS-1,2-DICHLOROETHENE	NA	--	--	NA	--	--	NA	--	--	NA	--	--
	TRICHLOROETHENE	ND	U	125	ND	U	100	68	J	100	NA	--	--
TRICHLOROFUOROMETHANE	ND	U	250	ND	U	200	ND	U	200	NA	--	--	
VINYL CHLORIDE	NA	--	--	NA	--	--	NA	--	--	NA	--	--	
XYLENES	4260		375	5320		300	4610		300	NA	--	--	

Refer to notes at the end of the table.

Table 13
Analytical Data Table for KAFB-106MW1-S

Phase Designation		Phase 3 Recirculation									Phase 3 Passive		
Sample ID		106MW1S-P3R-081518			106MW1S-P3R-082118			106MW1S-P3R-082818			106MW1S-P3P-091118		
Sample Date		8/15/2018			8/21/2018			8/28/2018			9/11/2018		
Sample Purpose		REG			REG			REG			REG		
Chemical Class and Analytical Method ^a	Parameter	Result	Val Qual	LOQ	Result	Val Qual	LOQ	Result	Val Qual	LOQ	Result	Val Qual	LOQ
Microbial Community (cells/mL) QuantArray-Chlor	1,1 DCA Reductase (DCA)	NS	--	--	ND	U	4.8	NS	--	--	NS	--	--
	1,2 DCA Reductase (DCAR)	NS	--	--	ND	U	4.8	NS	--	--	NS	--	--
	BAV1 Vinyl Chloride Reductase (BVC)	NS	--	--	ND	U	0.5	NS	--	--	NS	--	--
	cer A Reductase	NS	--	--	ND	U	4.8	NS	--	--	NS	--	--
	Chloroform Reductase (CFR)	NS	--	--	ND	U	4.8	NS	--	--	NS	--	--
	Dehalobacter DCM (DCM)	NS	--	--	926		4.8	NS	--	--	NS	--	--
	Dehalobacter spp. (DHBt)	NS	--	--	212000		4.8	NS	--	--	NS	--	--
	Dehalobium chlorocoercia (DECO)	NS	--	--	21800		4.8	NS	--	--	NS	--	--
	Dehalococcoides (DHC)	NS	--	--	ND	U	0.5	NS	--	--	NS	--	--
	Dehalogenimonas spp. (DHG)	NS	--	--	ND	U	4.8	NS	--	--	NS	--	--
	Desulfitobacterium spp. (DSB)	NS	--	--	71700		4.8	NS	--	--	NS	--	--
	Desulfuromonas spp. (DSM)	NS	--	--	ND	U	4.8	NS	--	--	NS	--	--
	Dichloromethane Dehalogenase (DCMA)	NS	--	--	ND	U	4.8	NS	--	--	NS	--	--
	Epoxyalkane Transferase (EtnE)	NS	--	--	123		4.8	NS	--	--	NS	--	--
	Ethene Monooxygenase (EtnC)	NS	--	--	ND	U	4.8	NS	--	--	NS	--	--
	Methanogens (MGN)	NS	--	--	1160		4.8	NS	--	--	NS	--	--
	PCE Reductase (PCE-1)	NS	--	--	ND	U	4.8	NS	--	--	NS	--	--
	Phenol Hydroxylase (PHE)	NS	--	--	17000		4.8	NS	--	--	NS	--	--
	PMMO	NS	--	--	NA	--	--	NS	--	--	NS	--	--
	Soluble Methane Monooxygenase (SMMO)	NS	--	--	412		4.8	NS	--	--	NS	--	--
	Sulfate Reducing Bacteria (APS)	NS	--	--	177000		4.8	NS	--	--	NS	--	--
	tceA Reductase (TCE)	NS	--	--	ND	U	0.5	NS	--	--	NS	--	--
	Toluene Dioxygenase (TOD)	NS	--	--	ND	U	4.8	NS	--	--	NS	--	--
Toluene Monooxygenase (RMO)	NS	--	--	58600		4.8	NS	--	--	NS	--	--	
Toluene Monooxygenase 2 (RDEG)	NS	--	--	11400		4.8	NS	--	--	NS	--	--	
Total Eubacteria (EBAC)	NS	--	--	12900000		4.8	NS	--	--	NS	--	--	
trans-1,2-DCE Reductase (TDR)	NS	--	--	ND	U	4.8	NS	--	--	NS	--	--	
Trichlorobenzene Dioxygenase (TCBO)	NS	--	--	ND	U	4.8	NS	--	--	NS	--	--	
Vinyl Chloride Reductase (VCR)	NS	--	--	ND	U	0.5	NS	--	--	NS	--	--	
EDB (µg/L) EPA Method 8011	1,2-DIBROMOETHANE	11		0.03	8.4		0.03	8.5		0.03	5.5		0.029
VFAs (mg/L) EPA Method 300m	ACETIC ACID	98.2		10	105		10	105.2		10	90.5		10
	BUTYRIC ACID	ND	U	1	ND	U	1	ND	U	1	ND	U	1
	FORMIC ACID	0.8	J	10	0.8	J	10	0.9	J	10	ND	U	1
	LACTIC ACID	ND	U	1	ND	U	1	ND	U	1	ND	U	1
	PROPIONIC ACID	15.2		10	38.5		10	56.1		10	62.1		10
	PYRUVIC ACID	ND	U	1	ND	U	1	ND	U	1	ND	U	1
VALERIC ACID	ND	U	1	ND	U	1	ND	U	1	ND	U	1	
Fluorometric (µg/L) Spectrofluorophotometry	FLUORESCEIN												
Reduced Gases (µg/L) RSKSOP-175	ACETYLENE	ND	U	10	ND	U	10	ND	U	10	ND	U	10
	ETHANE	4.5		4	4.4		4	5.2		4	3.7	J	4
	ETHYLENE	11.5		5	11.2		5	14.3		5	10.9		5
	METHANE	24		2	36.2		2	170.2		2	771.1		2
	PROPANE	6.7		6	6.6		6	8.2		6	6.8		6
General Chemistry (mg/L) SM2320b, EPA Method 300, EPA Method 353.2, SM4500 PE ^c	ALKALINITY	410		5	420		5	440		5	440		5
	BROMIDE	0.89		0.5	0.82		0.5	1		0.5	0.82		0.5
	CHLORIDE	53		0.5	53		0.5	55		0.5	52		0.5
	IODIDE	6.3		0.75	5.8		0.75	6.2		0.75	6.3		0.75
	NITRATE	NA	--	--	NA	--	--	NA	--	--	NA	--	--
	NITRITE	NA	--	--	NA	--	--	NA	--	--	NA	--	--
NITROGEN, NITRATE-NITRITE	ND	U	0.05	ND		0.05	ND	U	0.05	ND	U	0.1	

Table 13
Analytical Data Table for KAFB-106MW1-S

Phase Designation		Phase 3 Recirculation									Phase 3 Passive		
Sample ID		106MW1S-P3R-081518			106MW1S-P3R-082118			106MW1S-P3R-082818			106MW1S-P3P-091118		
Sample Date		8/15/2018			8/21/2018			8/28/2018			9/11/2018		
Sample Purpose		REG			REG			REG			REG		
Chemical Class and Analytical Method ^a	Parameter	Result	Val Qual	LOQ	Result	Val Qual	LOQ	Result	Val Qual	LOQ	Result	Val Qual	LOQ
General Chemistry (mg/L) SM2320b, EPA Method 300, EPA Method 353.2, SM4500 Pec	O-PHOSPHATE (AS P)	NA	--	--	NA	--	--	NA	--	--	NA	--	--
	ORTHOPHOSPHATE	ND	U	0.15	ND		0.15	ND	U	0.15	ND	U	0.15
	PHOSPHORUS	NA	--	--	NA	--	--	NA	--	--	NA	--	--
	SULFATE	0.5	J	1	ND		1	ND	U	1	ND	U	1
Metals (mg/L) EPA Method 6010	LEAD	NS	--	--	NS	--	--	NS	--	--	NS	--	--
Dissolved Metals (mg/L) EPA Method 6010	IRON	5		0.05	4.9		0.05	5.4		0.05	6.2		0.05
	MANGANESE	5.9		0.003	6.1		0.003	6		0.003	6.6		0.003
δ ² H (‰) Mass Spectrometry, USGS Reston, VA	DELTA2H	NS	--	--	NS	--	--	NS	--	--	NS	--	--
CSIA EDB δ ¹³ C (‰) Kuder et al, 2012	EDB δ	NS	--	--	-4.1 ±1.5‰	--	--	NS	--	--	-5.6 ±1.5‰	--	--
VOCs (µg/L) EPA Method 8260	1,1,2-TRICHLOROETHANE	ND	U	50	ND	U	50	83	J	50	ND	U	50
	1,2,4-TRICHLOROBENZENE	NA	--	--	NA	--	--	NA	--	--	NA	--	--
	1,2,4-TRIMETHYLBENZENE	470		100	440		100	670		100	430		100
	1,2-DIBROMOETHANE	ND	U	100	ND	U	100	ND	U	100	ND	U	100
	1,2-DICHLOROETHANE	NS	--	--	NS	--	--	NS	--	--	NS	--	--
	1,3,5-TRIMETHYLBENZENE	160		50	150		50	380		50	140		50
	2-BUTANONE	ND	U	1000	ND	U	1000	ND	U	1000	ND	U	1000
	2-CHLOROTOLUENE	ND	U	50	ND	U	50	280		50	ND	U	50
	2-HEXANONE	ND	U	500	ND	U	500	ND	U	500	ND	U	500
	4-METHYL-2-PENTANONE	ND	U	500	ND	U	500	ND	U	500	ND	U	500
	ACETONE	ND	U	1000	ND	U	1000	ND	U	1000	ND	U	1000
	BENZENE	3400		100	3400		100	3700		100	3100		100
	CARBON DISULFIDE	ND	U	200	ND	U	200	ND	U	200	ND	U	200
	CHLOROMETHANE	ND	U	100	ND	U	100	ND	U	100	ND	U	100
	CIS-1,2-DICHLOROETHENE	NA	--	--	NA	--	--	NA	--	--	NA	--	--
	DICHLORODIFLUOROMETHANE	ND	U	100	ND	U	20	ND	U	100	ND	U	100
	ETHYLBENZENE	1200		100	1100		20	1500		100	1200		100
	ISOPROPYLBENZENE	130		100	120		100	360		100	100		100
	M,P-XYLENES	NA	--	--	NA	--	--	NA	--	--	NA	--	--
	METHYL TERT-BUTYL ETHER	ND	U	50	ND	U	50	ND	U	50	ND	U	50
	METHYLENE CHLORIDE	ND	U	500	ND	U	500	410	J	500	ND	U	500
	NAPHTHALENE	ND	U	500	ND	U	500	360	J	500	ND	U	500
	N-BUTYLBENZENE	ND	U	100	ND	U	100	200		100	ND	U	100
	N-PROPYLBENZENE	120		100	110		100	340		100	100		100
	O-XYLENE	NA	--	--	NA	--	--	NA	--	--	NA	--	--
	P-ISOPROPYLTOLUENE	71	J	100	51	J	100	260		100	ND	U	100
	SEC-BUTYLBENZENE	ND	U	100	ND	U	100	220		100	ND	U	100
	TERT-BUTYLBENZENE	ND	U	100	ND	U	100	220		100	ND	U	100
TETRACHLOROETHENE	NA	--	--	NA	--	--	NA	--	--	NA	--	--	
TOLUENE	7800		100	8400		100	9900		100	8200		100	
TRANS-1,2-DICHLOROETHENE	NA	--	--	NA	--	--	NA	--	--	NA	--	--	
TRICHLOROETHENE	ND	U	100	ND	U	100	120		100	ND	U	100	
TRICHLOROFUOROMETHANE	ND	U	100	ND	U	100	ND	U	100	ND	U	100	
VINYL CHLORIDE	NA	--	--	NA	--	--	NA	--	--	NA	--	--	
XYLENES	4100		50	4100		50	4900		50	4000		50	

Refer to notes at the end of the table.

Table 13
Analytical Data Table for KAFB-106MW1-S

Phase Designation		Phase 3 Passive									Phase 4 Passive		
Sample ID		106MW1S-P3P-100318			106MW1S-P3P-100318-FD			106MW1S-P3P-111418			106MW1S-P4P-011619		
Sample Date		10/3/2018			10/3/2018			11/14/2018			1/16/2019		
Sample Purpose		REG			FD			REG			REG		
Chemical Class and Analytical Method ^a	Parameter	Result	Val Qual	LOQ	Result	Val Qual	LOQ	Result	Val Qual	LOQ	Result	Val Qual	LOQ
Microbial Community (cells/mL) QuantArray-Chlor	1,1 DCA Reductase (DCA)	NS	--	--	NS	--	--	ND	U	5.2	ND	U	5.1
	1,2 DCA Reductase (DCAR)	NS	--	--	NS	--	--	ND	U	5.2	ND	U	5.1
	BAV1 Vinyl Chloride Reductase (BVC)	NS	--	--	NS	--	--	ND	U	0.5	ND	U	0.5
	cer A Reductase	NS	--	--	NS	--	--	ND	U	5.2	ND	U	5.1
	Chloroform Reductase (CFR)	NS	--	--	NS	--	--	ND	U	5.2	ND	U	5.1
	Dehalobacter DCM (DCM)	NS	--	--	NS	--	--	4430		5.2	983		5.1
	Dehalobacter spp. (DHBt)	NS	--	--	NS	--	--	341000		5.2	330000		5.1
	Dehalobium chlorocoercia (DECO)	NS	--	--	NS	--	--	3830		5.2	6510		5.1
	Dehalococcoides (DHC)	NS	--	--	NS	--	--	ND	U	0.5	0.4	J	0.5
	Dehalogenimonas spp. (DHG)	NS	--	--	NS	--	--	ND	U	5.2	ND	U	5.1
	Desulfitobacterium spp. (DSB)	NS	--	--	NS	--	--	42200		5.2	74100		5.1
	Desulfuromonas spp. (DSM)	NS	--	--	NS	--	--	5.3		5.2	5.2		5.1
	Dichloromethane Dehalogenase (DCMA)	NS	--	--	NS	--	--	ND	U	5.2	ND	U	5.1
	Epoxyalkane Transferase (EtnE)	NS	--	--	NS	--	--	70.2		5.2	ND	U	5.1
	Ethene Monooxygenase (EtnC)	NS	--	--	NS	--	--	ND	U	5.2	ND	U	5.1
	Methanogens (MGN)	NS	--	--	NS	--	--	27100		5.2	6250		5.1
	PCE Reductase (PCE-1)	NS	--	--	NS	--	--	ND	U	5.2	ND	U	5.1
	Phenol Hydroxylase (PHE)	NS	--	--	NS	--	--	35600		5.2	9940		5.1
	PMMO	NS	--	--	NS	--	--	NA	--	--	NA	--	--
	Soluble Methane Monooxygenase (SMMO)	NS	--	--	NS	--	--	ND	U	5.2	318		5.1
Sulfate Reducing Bacteria (APS)	NS	--	--	NS	--	--	16200		5.2	37300		5.1	
tceA Reductase (TCE)	NS	--	--	NS	--	--	ND	U	0.5	ND	U	0.5	
Toluene Dioxygenase (TOD)	NS	--	--	NS	--	--	ND	U	5.2	ND	U	5.1	
Toluene Monooxygenase (RMO)	NS	--	--	NS	--	--	28700		5.2	32800		5.1	
Toluene Monooxygenase 2 (RDEG)	NS	--	--	NS	--	--	15500		5.2	9280		5.1	
Total Eubacteria (EBAC)	NS	--	--	NS	--	--	9780000		5.2	27900000		5.1	
trans-1,2-DCE Reductase (TDR)	NS	--	--	NS	--	--	ND	U	5.2	ND	U	5.1	
Trichlorobenzene Dioxygenase (TCBO)	NS	--	--	NS	--	--	ND	U	5.2	ND	U	5.1	
Vinyl Chloride Reductase (VCR)	NS	--	--	NS	--	--	ND	U	0.5	ND	U	0.5	
EDB (µg/L) EPA Method 8011	1,2-DIBROMOETHANE	3.2		0.015	3.9		0.03	5.2		0.029	1.1	J-	0.003
VFAs (mg/L) EPA Method 300m	ACETIC ACID	105.1		10	106.6		10	111.2		10	115.6		10
	BUTYRIC ACID	ND	U	1	ND	U	1	ND	U	1	ND	U	1
	FORMIC ACID	1.6	J	10	1.5	J	10	0.9	J	1	1.9	J	10
	LACTIC ACID	ND	U	1	ND	U	1	0.9	J	1	0.9	J	1
	PROPIONIC ACID	57.7		10	60		10	24.4		10	10.1		10
	PYRUVIC ACID	ND	U	1	ND	U	1	ND	U	1	ND	U	1
VALERIC ACID	ND	U	1	ND	U	1	ND	U	1	ND	U	1	
Fluorometric (µg/L) Spectrofluorophotometry	FLUORESCEIN												
Reduced Gases (µg/L) RSKSOP-175	ACETYLENE	ND	U	10	ND	U	10	ND	U	10	ND	U	10
	ETHANE	4.9		4	4.7		4	12.2		4	15.7		4
	ETHYLENE	13.4		5	13.3		5	28.3		5	21.6		5
	METHANE	1436.2		2	1384		2	1071.6		2	3114.4		2
	PROPANE	7.2		6	7		6	11.2		6	11.6		6
General Chemistry (mg/L) SM2320b, EPA Method 300, EPA Method 353.2, SM4500 PE ^c	ALKALINITY	460		5	470		5	470		5	470		5
	BROMIDE	2		0.5	2.1		0.5	1.3		0.5	0.89		0.5
	CHLORIDE	49		0.5	50		0.5	49		0.5	50		0.5
	IODIDE	5		0.75	5.1		0.75	4.2	J+	0.75	3.9	J+	1.5
	NITRATE	NA	--	--	NA	--	--	NA	--	--	NA	--	--
	NITRITE	NA	--	--	NA	--	--	NA	--	--	NA	--	--
NITROGEN, NITRATE-NITRITE	ND	U	0.05	ND	U	0.05	0.027	J	0.05	ND	UJ	0.05	

Table 13
Analytical Data Table for KAFB-106MW1-S

Phase Designation		Phase 3 Passive									Phase 4 Passive		
Sample ID		106MW1S-P3P-100318			106MW1S-P3P-100318-FD			106MW1S-P3P-111418			106MW1S-P4P-011619		
Sample Date		10/3/2018			10/3/2018			11/14/2018			1/16/2019		
Sample Purpose		REG			FD			REG			REG		
Chemical Class and Analytical Method ^a	Parameter	Result	Val Qual	LOQ	Result	Val Qual	LOQ	Result	Val Qual	LOQ	Result	Val Qual	LOQ
General Chemistry (mg/L) SM2320b, EPA Method 300, EPA Method 353.2, SM4500 Pec	O-PHOSPHATE (AS P)	NA	--	--	NA	--	--	NA	--	--	NA	--	--
	ORTHOPHOSPHATE	ND	U	0.15	ND	U	0.15	ND	U	0.75	ND	U	0.15
	PHOSPHORUS	NA	--	--	NA	--	--	NA	--	--	NA	--	--
	SULFATE	ND	U	1	ND	U	1	ND	U	1	ND	U	1
Metals (mg/L) EPA Method 6010	LEAD	NS	--	--	NS	--	--	NS	--	--	NS	--	--
Dissolved Metals (mg/L) EPA Method 6010	IRON	7.3		0.05	7.5		0.05	9.2		0.05	9		0.05
	MANGANESE	7.2		0.003	7.5		0.003	8		0.003	7.7		0.003
δ2H (‰) Mass Spectrometry, USGS Reston, VA	DELTA2H	NS	--	--	NS	--	--	NS	--	--	NS	--	--
CSIA EDB δ13C (‰) Kuder et al, 2012	EDB δ	NS	--	--	NS	--	--	NS	--	--	NS	--	--
VOCs (µg/L) EPA Method 8260	1,1,2-TRICHLOROETHANE	ND	U	50	ND	U	50	ND	U	50	ND	U	50
	1,2,4-TRICHLOROBENZENE	NA	--	--	NA	--	--	NA	--	--	NA	--	--
	1,2,4-TRIMETHYLBENZENE	430		100	420		100	420		100	440		100
	1,2-DIBROMOETHANE	ND	U	100	ND	U	100	ND	U	100	ND	U	100
	1,2-DICHLOROETHANE	NS	--	--	NS	--	--	NS	--	--	NS	--	--
	1,3,5-TRIMETHYLBENZENE	140		50	140		50	150		50	150		50
	2-BUTANONE	ND	U	1000	ND	U	1000	ND	U	1000	ND	U	1000
	2-CHLOROTOLUENE	ND	U	50	ND	U	50	ND	U	50	ND	U	50
	2-HEXANONE	ND	U	500	ND	U	500	ND	U	500	ND	U	500
	4-METHYL-2-PENTANONE	ND	U	500	ND	U	500	ND	U	500	ND	U	500
	ACETONE	ND	U	1000	ND	U	1000	ND	U	1000	ND	U	1000
	BENZENE	4100		100	4000		100	9800		100	8800		100
	CARBON DISULFIDE	ND	U	200	ND	U	200	ND	U	200	ND	U	200
	CHLOROMETHANE	ND	U	100	ND	U	100	ND	U	100	ND	U	100
	CIS-1,2-DICHLOROETHENE	NA	--	--	NA	--	--	NA	--	--	NA	--	--
	DICHLORODIFLUOROMETHANE	ND	U	100	ND	U	100	ND	U	100	NA	--	--
	ETHYLBENZENE	1300		100	1300		100	1500		100	NA	--	--
	ISOPROPYLBENZENE	110		100	110		100	110		100	110		100
	M,P-XYLENES	NA	--	--	NA	--	--	NA	--	--	NA	--	--
	METHYL TERT-BUTYL ETHER	ND	U	50	ND	U	50	ND	U	50	ND	U	50
	METHYLENE CHLORIDE	ND	U	500	ND	U	500	ND	U	500	ND	U	500
	NAPHTHALENE	ND	U	500	ND	U	500	ND	U	500	ND	U	500
	N-BUTYLBENZENE	ND	U	100	ND	U	100	ND	U	100	ND	U	100
	N-PROPYLBENZENE	130		100	120		100	120		100	120		100
	O-XYLENE	NA	--	--	NA	--	--	NA	--	--	NA	--	--
	P-ISOPROPYLTOLUENE	ND	U	100	ND	U	100	ND	U	100	ND	U	100
	SEC-BUTYLBENZENE	ND	U	100	ND	U	100	ND	U	100	ND	U	100
	TERT-BUTYLBENZENE	ND	U	100	ND	U	100	ND	U	100	ND	U	100
	TETRACHLOROETHENE	NA	--	--	NA	--	--	NA	--	--	NA	--	--
	TOLUENE	11000		100	11000		100	18000		100	23000		200
	TRANS-1,2-DICHLOROETHENE	NA	--	--	NA	--	--	NA	--	--	NA	--	--
TRICHLOROETHENE	ND	U	100	ND	U	100	ND	U	100	ND	U	100	
TRICHLOROFUOROMETHANE	ND	U	100	ND	U	100	ND	U	100	ND	U	100	
VINYL CHLORIDE	NA	--	--	NA	--	--	NA	--	--	NA	--	--	
XYLENES	4400		50	4200		50	5000		50	4600		50	

Refer to notes at the end of the table.

Table 13
Analytical Data Table for KAFB-106MW1-S

Phase Designation		Phase 4 Passive											
Sample ID		106MW1S-LTM-031220			106MW1S-LTM-052020			106MW1S-LTM-080520			106MW1S-LTM-101320		
Sample Date		3/12/2020			5/20/2020			8/5/2020			10/13/2020		
Sample Purpose		REG			REG			REG			REG		
Chemical Class and Analytical Method ^a	Parameter	Result	Val Qual	LOQ	Result	Val Qual	LOQ	Result	Val Qual	LOQ	Result	Val Qual	LOQ
Microbial Community (cells/mL) QuantArray-Chlor	1,1 DCA Reductase (DCA)	ND	U	5.3	ND	U	5.1	ND	U	4.8	5		5
	1,2 DCA Reductase (DCAR)	ND	U	5.3	ND	U	5.1	ND	U	4.8	5		5
	BAV1 Vinyl Chloride Reductase (BVC)	ND	U	0.5	ND	U	0.5	ND	U	0.5	0.5		0.5
	cer A Reductase	ND	U	5.3	ND	U	5.1	ND	U	4.8	5		5
	Chloroform Reductase (CFR)	ND	U	5.3	ND	U	5.1	ND	U	4.8	5		5
	Dehalobacter DCM (DCM)	324		5.3	ND	U	5.1	ND	U	4.8	5		5
	Dehalobacter spp. (DHBt)	399000		5.3	153000		5.1	211000		4.8	31500		5
	Dehalobium chlorocoercia (DECO)	2910		5.3	3140		5.1	5680		4.8	899		5
	Dehalococcoides (DHC)	0.5	J	0.5	0.5		0.5	0.2	J	0.5	0.6		0.5
	Dehalogenimonas spp. (DHG)	ND	U	5.3	ND	U	5.1	ND	U	4.8	5		5
	Desulfitobacterium spp. (DSB)	135000		5.3	78800		5.1	113000		4.8	23800		5
	Desulfuromonas spp. (DSM)	ND	U	5.3	ND	U	5.1	9.5		4.8	1.4		5
	Dichloromethane Dehalogenase (DCMA)	ND	U	5.3	ND	U	5.1	ND	U	4.8	5		5
	Epoxyalkane Transferase (EtnE)	5.8		5.3	26.8		5.1	ND	U	4.8	11.2		5
	Ethene Monooxygenase (EtnC)	ND	U	5.3	ND	U	5.1	ND	U	4.8	5		5
	Methanogens (MGN)	39600		5.3	51000		5.1	43600		4.8	16700		5
	PCE Reductase (PCE-1)	ND	U	5.3	ND	U	5.1	ND	U	4.8	5		5
	Phenol Hydroxylase (PHE)	6780		5.3	8020		5.1	6750		4.8	1970		5
	PMMO	NA	--	--	NA	--	--	NA	--	--	NA	--	--
	Soluble Methane Monooxygenase (SMMO)	588		5.3	599		5.1	2280		4.8	137		5
	Sulfate Reducing Bacteria (APS)	27600		5.3	18700		5.1	56400		4.8	11200		5
	tceA Reductase (TCE)	ND	U	0.5	ND	U	0.5	ND	U	0.5	0.5		0.5
	Toluene Dioxygenase (TOD)	ND	U	5.3	ND	U	5.1	ND	U	4.8	5		5
Toluene Monooxygenase (RMO)	15400		5.3	15100		5.1	134000		4.8	20900		5	
Toluene Monooxygenase 2 (RDEG)	3470		5.3	4100		5.1	5410		4.8	1050		5	
Total Eubacteria (EBAC)	15200000		5.3	7470000		5.1	17900000		4.8	4310000		5	
trans-1,2-DCE Reductase (TDR)	ND	U	5.3	ND	U	5.1	ND	U	4.8	5		5	
Trichlorobenzene Dioxygenase (TCBO)	ND	U	5.3	ND	U	5.1	ND	U	4.8	5		5	
Vinyl Chloride Reductase (VCR)	ND	U	0.5	ND	U	0.5	ND	U	0.5	0.5		0.5	
EDB (µg/L) EPA Method 8011	1,2-DIBROMOETHANE	1.2		0.053	0.21		0.01	0.15		0.011	ND	U	0.01
VFAs (mg/L) EPA Method 300m	ACETIC ACID	11.4		10	ND	U	10	ND	U	10	ND	U	10
	BUTYRIC ACID	ND	U	1	ND	U	10	ND	U	10	ND	U	10
	FORMIC ACID	0.7	J	10	0.3	J	10	0.7	J	10	1.6	J	10
	LACTIC ACID	0.8	J	10	ND	U	10	ND	U	10	0.6	J	10
	PROPIONIC ACID	ND	U	1	ND	U	10	ND	U	10	ND	U	10
	PYRUVIC ACID	ND	U	1	ND	U	10	ND	U	10	ND	U	10
VALERIC ACID	ND	U	1	ND	U	10	ND	U	10	ND	U	10	
Fluorometric (µg/L) Spectrofluorophotometry	FLUORESC EIN												
Reduced Gases (µg/L) RSKSOP-175	ACETYLENE	ND	U	10	ND	U	10	ND	U	10	ND	U	10
	ETHANE	2.2	J	4	9.2		4	6.4		4	2.1		4
	ETHYLENE	1.9	J	5	13.4		5	8.5		5	2.9		5
	METHANE	2874.8		2	7863.8		2	6344.1		2	3672.3		2
	PROPANE	1.3	J	6	7.7		6	6.6		6	2.9	J	6
General Chemistry (mg/L) SM2320b, EPA Method 300, EPA Method 353.2, SM4500 PE ^c	ALKALINITY	602		5	574		5	543		5	484		5
	BROMIDE	1.36		0.1	1.42		0.1	2.51		0.1	1.84		0.1
	CHLORIDE	58.2		0.5	72.6		0.5	65.8		0.5	48.6		0.5
	IODIDE	6		0.2	4.8		0.2	4.9		2	4.7		
	NITRATE	0.0687	J	0.1	0.0678	J	0.1	0.112		0.1	0.0764	J	0.1
	NITRITE	NA	--	--	NA	--	--	NA	--	--	NA	--	--
NITROGEN, NITRATE-NITRITE	ND	U	0.1	ND	U	0.1	ND	U	0.1	ND	U	0.1	

Table 13
Analytical Data Table for KAFB-106MW1-S

Phase Designation		Phase 4 Passive											
Sample ID		106MW1S-LTM-031220			106MW1S-LTM-052020			106MW1S-LTM-080520			106MW1S-LTM-101320		
Sample Date		3/12/2020			5/20/2020			8/5/2020			10/13/2020		
Sample Purpose		REG			REG			REG			REG		
Chemical Class and Analytical Method ^a	Parameter	Result	Val Qual	LOQ	Result	Val Qual	LOQ	Result	Val Qual	LOQ	Result	Val Qual	LOQ
General Chemistry (mg/L) SM2320b, EPA Method 300, EPA Method 353.2, SM4500 Pec	O-PHOSPHATE (AS P)	NA	--	--	NA	--	--	NA	--	--	NA	--	--
	ORTHOPHOSPHATE	NA	--	--	NA	--	--	NA	--	--	NA	--	--
	PHOSPHORUS	ND	U	0.025	ND	U	0.025	ND	U	0.025	0.012	J	0.025
	SULFATE	ND	U	0.5	0.218	J	0.5	2.2		0.5	0.469	J	0.5
Metals (mg/L) EPA Method 6010	LEAD	ND	U	0.001	ND	U	0.001	ND	U	0.001	ND	U	0.001
Dissolved Metals (mg/L) EPA Method 6010	IRON	8.74		0.05	9.08		0.05	11.2		0.05	8.85		0.05
	MANGANESE	7.46		0.125	7.19		0.125	6.95		0.125	5.72		0.125
δ2H (‰) Mass Spectrometry, USGS Reston, VA	DELTA2H	NS	--	--	NS	--	--	NS	--	--	NS	--	--
CSIA EDB δ13C (‰) Kuder et al, 2012	EDB δ	NS	--	--	NS	--	--	NS	--	--	NS	--	--
VOCs (µg/L) EPA Method 8260	1,1,2-TRICHLOROETHANE	ND	U	5	ND	U	5	ND	U	10	ND	U	10
	1,2,4-TRICHLOROBENZENE	ND	UJ	5	ND	U	5	ND	U	10	ND	U	10
	1,2,4-TRIMETHYLBENZENE	NA	--	--	NA	--	--	NA	--	--	NA	--	--
	1,2-DIBROMOETHANE	ND	U	5	ND	U	2.5	ND	U	5	ND	U	5
	1,2-DICHLOROETHANE	ND	U	5	ND	U	2.5	ND	U	5	ND	U	5
	1,3,5-TRIMETHYLBENZENE	130		5	130		5	140		10	170		5
	2-BUTANONE	ND	U	10	ND	U	5	ND	U	10	ND	U	10
	2-CHLOROTOLUENE	ND	U	5	ND	U	5	ND	U	10	ND	U	10
	2-HEXANONE	ND	U	10	ND	U	10	ND	U	20	ND	U	20
	4-METHYL-2-PENTANONE	97		10	63		10	ND	U	20	ND	U	20
	ACETONE	ND	U	10	20		5	75		10	ND	U	10
	BENZENE	5300	J+	50	4500		25	4800		50	2700		50
	CARBON DISULFIDE	ND	U	10	ND	U	5	ND	U	10	ND	U	20
	CHLOROMETHANE	ND	U	5	ND	U	2.5	ND	U	5	ND	U	5
	CIS-1,2-DICHLOROETHENE	ND	U	5	ND	U	2.5	ND	U	5	ND	U	5
	DICHLORODIFLUOROMETHANE	ND	U	5	ND	U	5	ND	U	10	ND	U	10
	ETHYLBENZENE	1300		5	1300		50	1300		10	1200		10
	ISOPROPYLBENZENE	90		5	86		5	100		10	98		10
	M,P-XYLENES	2900		10	3100		50	3100		10	2900		10
	METHYL TERT-BUTYL ETHER	ND	U	5	ND	U	2.5	ND	U	5	ND	U	5
	METHYLENE CHLORIDE	ND	U	10	ND	U	5	ND	U	10	ND	U	10
	NAPHTHALENE	100		5	130		5	160		10	150		10
	N-BUTYLBENZENE	16		5	15		5	17		10	ND	U	10
	N-PROPYLBENZENE	99		5	84		5	110		10	100		5
	O-XYLENE	1300		5	1400		50	1400		10	1300		5
	P-ISOPROPYLTOLUENE	ND	U	5	ND	U	5	ND	U	10	ND	U	5
	SEC-BUTYLBENZENE	19		5	16		5	18		10	22		10
	TERT-BUTYLBENZENE	ND	U	5	ND	U	5	ND	U	10	ND	U	5
	TETRACHLOROETHENE	ND	U	5	ND	U	5	ND	U	10	ND	U	10
	TOLUENE	12000		50	5800		25	4600		50	1000		5
	TRANS-1,2-DICHLOROETHENE	ND	U	5	ND	U	2.5	ND	U	5	ND	U	5
	TRICHLOROETHENE	ND	U	5	ND	U	2.5	ND	U	5	ND	U	5
TRICHLOROFUOROMETHANE	ND	U	5	ND	U	5	ND	U	10	ND	U	5	
VINYL CHLORIDE	ND	U	5	ND	U	2.5	ND	U	5	ND	U	5	
XYLENES	4200		5	4500		50	4500		10	4200		5	

Refer to notes at the end of the table.

Table 13
Analytical Data Table for KAFB-106MW1-S

Phase Designation		Phase 4 Passive		
Sample ID		106MW1S-LTM-101320-FD		
Sample Date		10/13/2020		
Sample Purpose		FD		
Chemical Class and Analytical Method ^a	Parameter	Result	Val Qual	LOQ
Microbial Community (cells/mL) QuantArray-Chlor	1,1 DCA Reductase (DCA)	NS	--	--
	1,2 DCA Reductase (DCAR)	NS	--	--
	BAV1 Vinyl Chloride Reductase (BVC)	NS	--	--
	cer A Reductase	NS	--	--
	Chloroform Reductase (CFR)	NS	--	--
	Dehalobacter DCM (DCM)	NS	--	--
	Dehalobacter spp. (DHBt)	NS	--	--
	Dehalobium chlorocoercia (DECO)	NS	--	--
	Dehalococcoides (DHC)	NS	--	--
	Dehalogenimonas spp. (DHG)	NS	--	--
	Desulfitobacterium spp. (DSB)	NS	--	--
	Desulfuromonas spp. (DSM)	NS	--	--
	Dichloromethane Dehalogenase (DCMA)	NS	--	--
	Epoxyalkane Transferase (EtnE)	NS	--	--
	Ethene Monooxygenase (EtnC)	NS	--	--
	Methanogens (MGN)	NS	--	--
	PCE Reductase (PCE-1)	NS	--	--
	Phenol Hydroxylase (PHE)	NS	--	--
	PMMO	NS	--	--
	Soluble Methane Monooxygenase (SMMO)	NS	--	--
	Sulfate Reducing Bacteria (APS)	NS	--	--
	tceA Reductase (TCE)	NS	--	--
	Toluene Dioxygenase (TOD)	NS	--	--
	Toluene Monooxygenase (RMO)	NS	--	--
Toluene Monooxygenase 2 (RDEG)	NS	--	--	
Total Eubacteria (EBAC)	NS	--	--	
trans-1,2-DCE Reductase (TDR)	NS	--	--	
Trichlorobenzene Dioxygenase (TCBO)	NS	--	--	
Vinyl Chloride Reductase (VCR)	NS	--	--	
EDB (µg/L) EPA Method 8011	1,2-DIBROMOETHANE	ND	U	0.011
VFAs (mg/L) EPA Method 300m	ACETIC ACID	10		10
	BUTYRIC ACID	ND	U	10
	FORMIC ACID	2.05	J	10
	LACTIC ACID	1.08	J	10
	PROPIONIC ACID	ND	U	10
	PYRUVIC ACID	ND	U	10
	VALERIC ACID	ND	U	10
Fluorometric (µg/L) Spectrofluorophotometry	FLUORESCIEIN			
Reduced Gases (µg/L) RSKSOP-175	ACETYLENE	ND	U	10
	ETHANE	1.63157029		4
	ETHYLENE	2.192087622		5
	METHANE	2800.23343		2
	PROPANE	2.375250736		6
General Chemistry (mg/L) SM2320b, EPA Method 300, EPA Method 353.2, SM4500 PE ^c	ALKALINITY	482		5
	BROMIDE	1.89		0.1
	CHLORIDE	50.4		0.5
	IODIDE	5		
	NITRATE	0.531		0.1
	NITRITE	NA	--	--
	NITROGEN, NITRATE-NITRITE	ND	U	0.1

Table 13
Analytical Data Table for KAFB-106MW1-S

Phase Designation		Phase 4 Passive		
Sample ID		106MW1S-LTM-101320-FD		
Sample Date		10/13/2020		
Sample Purpose		FD		
Chemical Class and Analytical Method ^a	Parameter	Result	Val Qual	LOQ
General Chemistry (mg/L) SM2320b, EPA Method 300, EPA Method 353.2, SM4500 Pec	O-PHOSPHATE (AS P)	NA	--	--
	ORTHOPHOSPHATE	NA	--	--
	PHOSPHORUS	ND	U	0.025
	SULFATE	0.232	J	0.5
Metals (mg/L) EPA Method 6010	LEAD	ND	U	0.001
Dissolved Metals (mg/L) EPA Method 6010	IRON	8		0.05
	MANGANESE	4.92		0.125
δ2H (‰) Mass Spectrometry, USGS Reston, VA	DELTA2H	NS	--	--
CSIA EDB δ13C (‰) Kuder et al, 2012	EDB δ	NS	--	--
VOCs (µg/L) EPA Method 8260	1,1,2-TRICHLOROETHANE	ND	U	5
	1,2,4-TRICHLOROBENZENE	ND	U	10
	1,2,4-TRIMETHYLBENZENE	NA	--	--
	1,2-DIBROMOETHANE	ND	U	5
	1,2-DICHLOROETHANE	ND	U	5
	1,3,5-TRIMETHYLBENZENE	170		10
	2-BUTANONE	ND	U	10
	2-CHLOROTOLUENE	ND	U	10
	2-HEXANONE	ND	U	20
	4-METHYL-2-PENTANONE	ND	U	20
	ACETONE	ND	U	10
	BENZENE	3100		50
	CARBON DISULFIDE	ND	U	20
	CHLOROMETHANE	ND	U	5
	CIS-1,2-DICHLOROETHENE	ND	U	5
	DICHLORODIFLUOROMETHANE	ND	U	5
	ETHYLBENZENE	1200		10
	ISOPROPYLBENZENE	100		5
	M,P-XYLENES	2900		10
	METHYL TERT-BUTYL ETHER	ND	U	5
	METHYLENE CHLORIDE	ND	U	10
	NAPHTHALENE	170		5
	N-BUTYLBENZENE	39		10
	N-PROPYLBENZENE	100		10
	O-XYLENE	1300		5
	P-ISOPROPYLTOLUENE	ND	U	10
	SEC-BUTYLBENZENE	22		5
	TERT-BUTYLBENZENE	ND	U	5
	TETRACHLOROETHENE	ND	U	5
	TOLUENE	1000		5
	TRANS-1,2-DICHLOROETHENE	ND	U	5
	TRICHLOROETHENE	ND	U	5
TRICHLOROFUOROMETHANE	ND	U	10	
VINYL CHLORIDE	ND	U	5	
XYLENES	4300		10	

Refer to notes at the end of the table.

Table 13
Analytical Data Table for KAFB-106MW1-S

Notes:

Sampling frequency for each analytical method is outlined in Table 4.

a. EPA analytical methods listed are for the most recent sampling event.

b. Samples were collected using replacement QED Bladder Pumps. This well was not sampled using the Geotech pumps.

-- = Not applicable.

δ2H - Delta Deuterium.

0/00 - Per mil.

cells/mL = Cells per milliliter.

EPA = Environmental Protection Agency.

FD = Field duplicate.

ID = Identification.

J = Estimated value, concentration is less than LOQ but greater than laboratory method detection limit (DL).

J+ = Estimated value, concentration is less than LOQ but greater than laboratory method detection limit (DL); biased high.

J- = Estimated value, concentration is less than LOQ but greater than laboratory method detection limit (DL); biased low.

KAFB = Kirtland Air Force Base.

LOQ = Limit of Quantitation

µg/L = Microgram per liter.

mg/L = Milligram per liter.

NA = Not analyzed.

ND = Not detected.

NS = Not sampled.

REG = Regular/parent sample.

U = Analyte was not detected. The reported numerical value is at or below the LOQ.

UJ = Analyte was not detected. The reported value is estimated.

VAL QUAL = Validation qualifier.

VFA - Volatile fatty acid.

VOC = Volatile organic compound.

Table 14
Analytical Data Table for KAFB-106MW2-I

Phase Designation		Original Baseline ^b						New Baseline - QED Pumps ^c					
Sample ID		106MW2I-BL-072417			106MW2I-BL-FD-072417			106MW2I-BL-091917			106MW2I-BL-FD-091917		
Sample Date		7/24/2017			7/24/2017			9/19/2017			9/19/2017		
Sample Purpose		REG			FD			REG			FD		
Chemical Class and Analytical Method ^a	Parameter	Result	Val Qual	LOQ	Result	Val Qual	LOQ	Result	Val Qual	LOQ	Result	Val Qual	LOQ
Microbial Community (cells/mL) QuantArray-Chlor	1,1 DCA Reductase (DCA)	ND	U	5.1	NS	--	--	NS	--	--	NS	--	--
	1,2 DCA Reductase (DCAR)	ND	U	5.1	NS	--	--	NS	--	--	NS	--	--
	BAV1 Vinyl Chloride Reductase (BVC)	ND	U	0.5	NS	--	--	NS	--	--	NS	--	--
	cer A Reductase	NA	--	--	NS	--	--	NS	--	--	NS	--	--
	Chloroform Reductase (CFR)	ND	U	5.1	NS	--	--	NS	--	--	NS	--	--
	Dehalobacter DCM (DCM)	ND	U	5.1	NS	--	--	NS	--	--	NS	--	--
	Dehalobacter spp. (DHBt)	3830		5.1	NS	--	--	NS	--	--	NS	--	--
	Dehalobium chloroocercia (DECO)	144		5.1	NS	--	--	NS	--	--	NS	--	--
	Dehalococcoides (DHC)	ND	U	0.5	NS	--	--	NS	--	--	NS	--	--
	Dehalogenimonas spp. (DHG)	ND	U	5.1	NS	--	--	NS	--	--	NS	--	--
	Desulfotobacterium spp. (DSB)	11000		5.1	NS	--	--	NS	--	--	NS	--	--
	Desulfuromonas spp. (DSM)	36.8		5.1	NS	--	--	NS	--	--	NS	--	--
	Dichloromethane Dehalogenase (DCMA)	ND	U	5.1	NS	--	--	NS	--	--	NS	--	--
	Epoxyalkane Transferase (EtnE)	ND	U	5.1	NS	--	--	NS	--	--	NS	--	--
	Ethene Monooxygenase (EtnC)	ND	U	5.1	NS	--	--	NS	--	--	NS	--	--
	Methanogens (MGN)	695		5.1	NS	--	--	NS	--	--	NS	--	--
	PCE Reductase (PCE-1)	NA	--	--	NS	--	--	NS	--	--	NS	--	--
	Phenol Hydroxylase (PHE)	10900		5.1	NS	--	--	NS	--	--	NS	--	--
	PMMO	696		5.1	NS	--	--	NS	--	--	NS	--	--
	Soluble Methane Monooxygenase (SMMO)	2380		5.1	NS	--	--	NS	--	--	NS	--	--
	Sulfate Reducing Bacteria (APS)	222		5.1	NS	--	--	NS	--	--	NS	--	--
	tceA Reductase (TCE)	ND	U	0.5	NS	--	--	NS	--	--	NS	--	--
	Toluene Dioxygenase (TOD)	206		5.1	NS	--	--	NS	--	--	NS	--	--
	Toluene Monooxygenase (RMO)	10500		5.1	NS	--	--	NS	--	--	NS	--	--
Toluene Monooxygenase 2 (RDEG)	15600		5.1	NS	--	--	NS	--	--	NS	--	--	
Total Eubacteria (EBAC)	209000		5.1	NS	--	--	NS	--	--	NS	--	--	
trans-1,2-DCE Reductase (TDR)	NA	--	--	NS	--	--	NS	--	--	NS	--	--	
Trichlorobenzene Dioxygenase (TCBO)	1390		5.1	NS	--	--	NS	--	--	NS	--	--	
Vinyl Chloride Reductase (VCR)	ND	U	0.5	NS	--	--	NS	--	--	NS	--	--	
EDB (µg/L) EPA Method 8011	1,2-DIBROMOETHANE	ND	UJ	0.019	ND	UJ	0.0189	0.072		0.0192	0.122		0.0193
VFAs (mg/L) EPA Method 300m	ACETIC ACID	ND	U	1	ND	U	1	0.59	J	1	0.31	J	1
	BUTYRIC ACID	ND	U	1	ND	U	1	ND	U	1	ND	U	1
	FORMIC ACID	ND	U	1	ND	U	1	ND	U	1	ND	U	1
	LACTIC ACID	ND	U	1	ND	U	1	1.08		1	0.97	J	1
	PROPIONIC ACID	ND	U	1	ND	U	1	ND	U	1	ND	U	1
	PYRUVIC ACID	ND	U	1	ND	U	1	ND	U	1	ND	U	1
VALERIC ACID	ND	U	1	ND	U	1	ND	U	1	ND	U	1	
Fluorometric (µg/L) Spectrofluorophotometry	FLUORESCEIN	ND	U	0.01	ND	U	0.01	ND	U	0.01	ND	U	0.01
Reduced Gases (µg/L) RSKSOP-175	ACETYLENE	ND	U	10	ND	U	10	ND	U	10	ND	U	10
	ETHANE	ND	U	4	ND	U	4	ND	U	4	ND	U	4
	ETHYLENE	ND	U	5	ND	U	5	ND	U	5	ND	U	5
	METHANE	ND	U	2	ND	U	2	7.2		2	6.86		2
	PROPANE	ND	U	6	ND	U	6	ND	U	6	ND	U	6
General Chemistry (mg/L) SM2320b, EPA Method 300, EPA Method 353.2, SM4500 Pec	ALKALINITY	190		1	186		1	194		1	207		1
	BROMIDE	0.196		0.125	0.193		0.125	0.249		0.125	0.287		0.125
	CHLORIDE	20.4		0.33	20.4		0.33	31.6		0.33	32.1		0.33
	IODIDE	ND	U	0.2	ND	U	0.2	ND	U	0.75	ND	U	0.75
	NITRATE	NA	--	--	NA	--	--	NA	--	--	NA	--	--
	NITRITE	NA	--	--	NA	--	--	NA	--	--	NA	--	--
	NITROGEN, NITRATE-NITRITE	ND	U	0.375	ND	U	0.375	ND	U	0.375	ND	U	0.375
	O-PHOSPHATE (AS P)	ND	U	0.02	0.0125		0.02	ND	U	0.02	ND	U	0.02
	ORTHOPHOSPHATE	NA	--	--	NA	--	--	NA	--	--	NA	--	--
	PHOSPHORUS	NA	--	--	NA	--	--	NA	--	--	NA	--	--
	SULFATE	23		1	23.1		1	19.2		1	19.8		1

Table 14
Analytical Data Table for KAFB-106MW2-I

Phase Designation		Original Baseline ^b						New Baseline - QED Pumps ^c					
Sample ID		106MW2I-BL-072417			106MW2I-BL-FD-072417			106MW2I-BL-091917			106MW2I-BL-FD-091917		
Sample Date		7/24/2017			7/24/2017			9/19/2017			9/19/2017		
Sample Purpose		REG			FD			REG			FD		
Chemical Class and Analytical Method ^a	Parameter	Result	Val Qual	LOQ	Result	Val Qual	LOQ	Result	Val Qual	LOQ	Result	Val Qual	LOQ
Metals (mg/L) EPA Method 6010	LEAD	NS	--	--	NS	--	--	NS	--	--	NS	--	--
Dissolved Metals (mg/L) EPA Method 6010	IRON	0.053		0.06	0.0514		0.06	0.955		0.06	0.996		0.06
	MANGANESE	0.154		0.006	0.142		0.006	0.392		0.006	0.405		0.006
δ2H (‰) Mass Spectrometry, USGS Reston, VA	DELTA2H	-97.17		-99	-97.04		-99	-96.44		-99	-96.4		-99
VOCs (µg/L) EPA Method 8260	1,1,2-TRICHLOROETHANE	ND	U	1	ND	U	1	ND	U	2.5	ND	U	1
	1,2,4-TRICHLOROBENZENE	NA	--	--	NA	--	--	NA	--	--	NA	--	--
	1,2,4-TRIMETHYLBENZENE	ND	U	1	ND	U	1	ND	U	2.5	ND	U	1
	1,2-DIBROMOETHANE	ND	U	1	ND	U	1	ND	U	2.5	ND	U	1
	1,2-DICHLOROETHANE	ND	U	1	ND	U	1	ND	U	2.5	0.78	J	1
	1,3,5-TRIMETHYLBENZENE	ND	U	1	ND	U	1	ND	U	2.5	ND	U	1
	2-BUTANONE	ND	U	10	ND	U	10	ND	U	25	ND	J-	10
	2-CHLOROTOLUENE	ND	U	1	ND	U	1	ND	U	2.5	ND	U	1
	2-HEXANONE	ND	U	5	ND	U	5	ND	U	12.5	ND	UJ	5
	4-METHYL-2-PENTANONE	ND	U	5	ND	U	5	ND	U	12.5	ND	UJ	5
	ACETONE	19.8	J	10	15.9	J	10	24.6	J	25	11.3	J	10
	BENZENE	ND	U	1	ND	U	1	ND	U	2.5	ND	U	1
	CARBON DISULFIDE	ND	U	1	ND	U	1	ND	U	2.5	ND	U	1
	CHLOROMETHANE	ND	U	1	ND	U	1	ND	U	2.5	ND	U	1
	CIS-1,2-DICHLOROETHENE	NA	--	--	NA	--	--	NA	--	--	NA	--	--
	DICHLORODIFLUOROMETHANE	ND	U	2	ND	U	2	ND	U	5	ND	U	2
	ETHYLBENZENE	ND	U	1	ND	U	1	ND	U	2.5	0.619	J	1
	ISOPROPYLBENZENE	ND	U	1	ND	U	1	1.46	J	2.5	1.51	J	1
	M,P-XYLENES	NA	--	--	NA	--	--	NA	--	--	NA	--	--
	METHYL TERT-BUTYL ETHER	ND	U	1	ND	U	1	ND	U	2.5	ND	U	1
	METHYLENE CHLORIDE	ND	U	2	ND	U	2	ND	U	5	ND	U	2
	NAPHTHALENE	ND	U	1	ND	U	1	1.34	J	2.5	ND	U	1
	N-BUTYLBENZENE	ND	U	1	ND	U	1	ND	U	2.5	ND	U	1
	N-PROPYLBENZENE	ND	U	1	ND	U	1	ND	U	2.5	ND	U	1
	O-XYLENE	NA	--	--	NA	--	--	NA	--	--	NA	--	--
	P-ISOPROPYLTOLUENE	ND	U	1	ND	U	1	1.29	J	2.5	ND	U	1
	SEC-BUTYLBENZENE	ND	U	1	ND	U	1	ND	U	2.5	ND	U	1
	TERT-BUTYLBENZENE	ND	U	1	ND	U	1	ND	U	2.5	ND	U	1
	TETRACHLOROETHENE	NA	--	--	NA	--	--	NA	--	--	NA	--	--
	TOLUENE	ND	U	1	0.69	J	1	5.61		2.5	2.71		1
	TRANS-1,2-DICHLOROETHENE	NA	--	--	NA	--	--	NA	--	--	NA	--	--
	TRICHLOROETHENE	ND	U	1	ND	U	1	ND	U	2.5	ND	U	1
	TRICHLOROFLUOROMETHANE	ND	U	2	ND	U	2	ND	U	5	ND	U	2
	VINYL CHLORIDE	NA	--	--	NA	--	--	NA	--	--	NA	--	--
	XYLENES	ND	U	3	ND	U	3	9.02	J	7.5	4.36	J	3

Refer to notes at the end of the table.

Table 14
Analytical Data Table for KAFB-106MW2-I

Phase Designation		Phase 1 Recirculation											
Sample ID		106MW2I-P1R-100417			106MW2I-P1R-100617			106MW2I-P1R-100917			106MW2I-P1R-101217		
Sample Date		10/4/2017			10/6/2017			10/9/2017			10/12/2017		
Sample Purpose		REG			REG			REG			REG		
Chemical Class and Analytical Method ^a	Parameter	Result	Val Qual	LOQ	Result	Val Qual	LOQ	Result	Val Qual	LOQ	Result	Val Qual	LOQ
Microbial Community (cells/mL) QuantArray-Chlor	1,1 DCA Reductase (DCA)	NS	--	--	NS	--	--	NS	--	--	NS	--	--
	1,2 DCA Reductase (DCAR)	NS	--	--	NS	--	--	NS	--	--	NS	--	--
	BAV1 Vinyl Chloride Reductase (BVC)	NS	--	--	NS	--	--	NS	--	--	NS	--	--
	cer A Reductase	NS	--	--	NS	--	--	NS	--	--	NS	--	--
	Chloroform Reductase (CFR)	NS	--	--	NS	--	--	NS	--	--	NS	--	--
	Dehalobacter DCM (DCM)	NS	--	--	NS	--	--	NS	--	--	NS	--	--
	Dehalobacter spp. (DHBT)	NS	--	--	NS	--	--	NS	--	--	NS	--	--
	Dehalobium chlorocoercia (DECO)	NS	--	--	NS	--	--	NS	--	--	NS	--	--
	Dehalococcoides (DHC)	NS	--	--	NS	--	--	NS	--	--	NS	--	--
	Dehalogenimonas spp. (DHG)	NS	--	--	NS	--	--	NS	--	--	NS	--	--
	Desulfobacterium spp. (DSB)	NS	--	--	NS	--	--	NS	--	--	NS	--	--
	Desulfuromonas spp. (DSM)	NS	--	--	NS	--	--	NS	--	--	NS	--	--
	Dichloromethane Dehalogenase (DCMA)	NS	--	--	NS	--	--	NS	--	--	NS	--	--
	Epoxyalkane Transferase (EtnE)	NS	--	--	NS	--	--	NS	--	--	NS	--	--
	Ethene Monooxygenase (EtnC)	NS	--	--	NS	--	--	NS	--	--	NS	--	--
	Methanogens (MGN)	NS	--	--	NS	--	--	NS	--	--	NS	--	--
	PCE Reductase (PCE-1)	NS	--	--	NS	--	--	NS	--	--	NS	--	--
	Phenol Hydroxylase (PHE)	NS	--	--	NS	--	--	NS	--	--	NS	--	--
	PMMO	NS	--	--	NS	--	--	NS	--	--	NS	--	--
	Soluble Methane Monooxygenase (SMMO)	NS	--	--	NS	--	--	NS	--	--	NS	--	--
	Sulfate Reducing Bacteria (APS)	NS	--	--	NS	--	--	NS	--	--	NS	--	--
	tceA Reductase (TCE)	NS	--	--	NS	--	--	NS	--	--	NS	--	--
	Toluene Dioxygenase (TOD)	NS	--	--	NS	--	--	NS	--	--	NS	--	--
	Toluene Monooxygenase (RMO)	NS	--	--	NS	--	--	NS	--	--	NS	--	--
Toluene Monooxygenase 2 (RDEG)	NS	--	--	NS	--	--	NS	--	--	NS	--	--	
Total Eubacteria (EBAC)	NS	--	--	NS	--	--	NS	--	--	NS	--	--	
trans-1,2-DCE Reductase (TDR)	NS	--	--	NS	--	--	NS	--	--	NS	--	--	
Trichlorobenzene Dioxygenase (TCBO)	NS	--	--	NS	--	--	NS	--	--	NS	--	--	
Vinyl Chloride Reductase (VCR)	NS	--	--	NS	--	--	NS	--	--	NS	--	--	
EDB (µg/L) EPA Method 8011	1,2-DIBROMOETHANE	NS	--	--	NS	--	--	NS	--	--	NS	--	--
VFAs (mg/L) EPA Method 300m	ACETIC ACID	NS	--	--	NS	--	--	NS	--	--	NS	--	--
	BUTYRIC ACID	NS	--	--	NS	--	--	NS	--	--	NS	--	--
	FORMIC ACID	NS	--	--	NS	--	--	NS	--	--	NS	--	--
	LACTIC ACID	NS	--	--	NS	--	--	NS	--	--	NS	--	--
	PROPIONIC ACID	NS	--	--	NS	--	--	NS	--	--	NS	--	--
	PYRUVIC ACID	NS	--	--	NS	--	--	NS	--	--	NS	--	--
	VALERIC ACID	NS	--	--	NS	--	--	NS	--	--	NS	--	--
Fluorometric (µg/L) Spectrofluorophotometry	FLUORESCEIN	ND	U	0.01	0.177		0.01	92.107		0.01	14.269		0.01
Reduced Gases (µg/L) RSKSOP-175	ACETYLENE	NS	--	--	NS	--	--	NS	--	--	NS	--	--
	ETHANE	NS	--	--	NS	--	--	NS	--	--	NS	--	--
	ETHYLENE	NS	--	--	NS	--	--	NS	--	--	NS	--	--
	METHANE	NS	--	--	NS	--	--	NS	--	--	NS	--	--
	PROPANE	NS	--	--	NS	--	--	NS	--	--	NS	--	--
General Chemistry (mg/L) SM2320b, EPA Method 300, EPA Method 353.2, SM4500 Pec	ALKALINITY	NS	--	--	NS	--	--	NS	--	--	NS	--	--
	BROMIDE	NS	--	--	NS	--	--	NS	--	--	NS	--	--
	CHLORIDE	NS	--	--	NS	--	--	NS	--	--	NS	--	--
	IODIDE	NS	--	--	NS	--	--	NS	--	--	NS	--	--
	NITRATE	NS	--	--	NS	--	--	NS	--	--	NS	--	--
	NITRITE	NS	--	--	NS	--	--	NS	--	--	NS	--	--
	NITROGEN, NITRATE-NITRITE	NS	--	--	NS	--	--	NS	--	--	NS	--	--
	O-PHOSPHATE (AS P)	NS	--	--	NS	--	--	NS	--	--	NS	--	--
	ORTHOPHOSPHATE	NS	--	--	NS	--	--	NS	--	--	NS	--	--
	PHOSPHORUS	NS	--	--	NS	--	--	NS	--	--	NS	--	--
SULFATE	NS	--	--	NS	--	--	NS	--	--	NS	--	--	

Table 14
Analytical Data Table for KAFB-106MW2-I

Phase Designation		Phase 1 Recirculation											
Sample ID		106MW2I-P1R-100417			106MW2I-P1R-100617			106MW2I-P1R-100917			106MW2I-P1R-101217		
Sample Date		10/4/2017			10/6/2017			10/9/2017			10/12/2017		
Sample Purpose		REG			REG			REG			REG		
Chemical Class and Analytical Method ^a	Parameter	Result	Val Qual	LOQ	Result	Val Qual	LOQ	Result	Val Qual	LOQ	Result	Val Qual	LOQ
Metals (mg/L) EPA Method 6010	LEAD	NS	--	--	NS	--	--	NS	--	--	NS	--	--
Dissolved Metals (mg/L) EPA Method 6010	IRON	NS	--	--	NS	--	--	NS	--	--	NS	--	--
	MANGANESE	NS	--	--	NS	--	--	NS	--	--	NS	--	--
δ2H (‰) Mass Spectrometry, USGS Reston, VA	DELTA2H	-96.22		-99	-96.38		-99	19.52		-99	-78.78		-99
VOCs (µg/L) EPA Method 8260	1,1,2-TRICHLOROETHANE	NS	--	--	NS	--	--	NS	--	--	NS	--	--
	1,2,4-TRICHLOROBENZENE	NS	--	--	NS	--	--	NS	--	--	NS	--	--
	1,2,4-TRIMETHYLBENZENE	NS	--	--	NS	--	--	NS	--	--	NS	--	--
	1,2-DIBROMOETHANE	NS	--	--	NS	--	--	NS	--	--	NS	--	--
	1,2-DICHLOROETHANE	NS	--	--	NS	--	--	NS	--	--	NS	--	--
	1,3,5-TRIMETHYLBENZENE	NS	--	--	NS	--	--	NS	--	--	NS	--	--
	2-BUTANONE	NS	--	--	NS	--	--	NS	--	--	NS	--	--
	2-CHLOROTOLUENE	NS	--	--	NS	--	--	NS	--	--	NS	--	--
	2-HEXANONE	NS	--	--	NS	--	--	NS	--	--	NS	--	--
	4-METHYL-2-PENTANONE	NS	--	--	NS	--	--	NS	--	--	NS	--	--
	ACETONE	NS	--	--	NS	--	--	NS	--	--	NS	--	--
	BENZENE	NS	--	--	NS	--	--	NS	--	--	NS	--	--
	CARBON DISULFIDE	NS	--	--	NS	--	--	NS	--	--	NS	--	--
	CHLOROMETHANE	NS	--	--	NS	--	--	NS	--	--	NS	--	--
	CIS-1,2-DICHLOROETHENE	NS	--	--	NS	--	--	NS	--	--	NS	--	--
	DICHLORODIFLUOROMETHANE	NS	--	--	NS	--	--	NS	--	--	NS	--	--
	ETHYLBENZENE	NS	--	--	NS	--	--	NS	--	--	NS	--	--
	ISOPROPYLBENZENE	NS	--	--	NS	--	--	NS	--	--	NS	--	--
	M,P-XYLENES	NS	--	--	NS	--	--	NS	--	--	NS	--	--
	METHYL TERT-BUTYL ETHER	NS	--	--	NS	--	--	NS	--	--	NS	--	--
	METHYLENE CHLORIDE	NS	--	--	NS	--	--	NS	--	--	NS	--	--
	NAPHTHALENE	NS	--	--	NS	--	--	NS	--	--	NS	--	--
	N-BUTYLBENZENE	NS	--	--	NS	--	--	NS	--	--	NS	--	--
	N-PROPYLBENZENE	NS	--	--	NS	--	--	NS	--	--	NS	--	--
	O-XYLENE	NS	--	--	NS	--	--	NS	--	--	NS	--	--
	P-ISOPROPYLTOLUENE	NS	--	--	NS	--	--	NS	--	--	NS	--	--
	SEC-BUTYLBENZENE	NS	--	--	NS	--	--	NS	--	--	NS	--	--
	TERT-BUTYLBENZENE	NS	--	--	NS	--	--	NS	--	--	NS	--	--
	TETRACHLOROETHENE	NS	--	--	NS	--	--	NS	--	--	NS	--	--
	TOLUENE	NS	--	--	NS	--	--	NS	--	--	NS	--	--
	TRANS-1,2-DICHLOROETHENE	NS	--	--	NS	--	--	NS	--	--	NS	--	--
	TRICHLOROETHENE	NS	--	--	NS	--	--	NS	--	--	NS	--	--
	TRICHLOROFUOROMETHANE	NS	--	--	NS	--	--	NS	--	--	NS	--	--
	VINYL CHLORIDE	NS	--	--	NS	--	--	NS	--	--	NS	--	--
	XYLENES	NS	--	--	NS	--	--	NS	--	--	NS	--	--

Refer to notes at the end of the table.

Table 14
Analytical Data Table for KAFB-106MW2-I

Phase Designation		Phase 1 Recirculation											
Sample ID		106MW2I-P1R-101617			106MW2I-P1R-102017			106MW2I-P1R-102017-FD			106MW2I-P1R-102517		
Sample Date		10/16/2017			10/20/2017			10/20/2017			10/25/2017		
Sample Purpose		REG			REG			FD			REG		
Chemical Class and Analytical Method ^a	Parameter	Result	Val Qual	LOQ	Result	Val Qual	LOQ	Result	Val Qual	LOQ	Result	Val Qual	LOQ
Microbial Community (cells/mL) QuantArray-Chlor	1,1 DCA Reductase (DCA)	NS	--	--	NS	--	--	NS	--	--	NS	--	--
	1,2 DCA Reductase (DCAR)	NS	--	--	NS	--	--	NS	--	--	NS	--	--
	BAV1 Vinyl Chloride Reductase (BVC)	NS	--	--	NS	--	--	NS	--	--	NS	--	--
	cer A Reductase	NS	--	--	NS	--	--	NS	--	--	NS	--	--
	Chloroform Reductase (CFR)	NS	--	--	NS	--	--	NS	--	--	NS	--	--
	Dehalobacter DCM (DCM)	NS	--	--	NS	--	--	NS	--	--	NS	--	--
	Dehalobacter spp. (DHBT)	NS	--	--	NS	--	--	NS	--	--	NS	--	--
	Dehalobium chloroocercia (DECO)	NS	--	--	NS	--	--	NS	--	--	NS	--	--
	Dehalococcoides (DHC)	NS	--	--	NS	--	--	NS	--	--	NS	--	--
	Dehalogenimonas spp. (DHG)	NS	--	--	NS	--	--	NS	--	--	NS	--	--
	Desulfobacterium spp. (DSB)	NS	--	--	NS	--	--	NS	--	--	NS	--	--
	Desulfuromonas spp. (DSM)	NS	--	--	NS	--	--	NS	--	--	NS	--	--
	Dichloromethane Dehalogenase (DCMA)	NS	--	--	NS	--	--	NS	--	--	NS	--	--
	Epoxyalkane Transferase (EtnE)	NS	--	--	NS	--	--	NS	--	--	NS	--	--
	Ethene Monooxygenase (EtnC)	NS	--	--	NS	--	--	NS	--	--	NS	--	--
	Methanogens (MGN)	NS	--	--	NS	--	--	NS	--	--	NS	--	--
	PCE Reductase (PCE-1)	NS	--	--	NS	--	--	NS	--	--	NS	--	--
	Phenol Hydroxylase (PHE)	NS	--	--	NS	--	--	NS	--	--	NS	--	--
	PMMO	NS	--	--	NS	--	--	NS	--	--	NS	--	--
	Soluble Methane Monooxygenase (SMMO)	NS	--	--	NS	--	--	NS	--	--	NS	--	--
	Sulfate Reducing Bacteria (APS)	NS	--	--	NS	--	--	NS	--	--	NS	--	--
	tceA Reductase (TCE)	NS	--	--	NS	--	--	NS	--	--	NS	--	--
	Toluene Dioxygenase (TOD)	NS	--	--	NS	--	--	NS	--	--	NS	--	--
	Toluene Monooxygenase (RMO)	NS	--	--	NS	--	--	NS	--	--	NS	--	--
Toluene Monooxygenase 2 (RDEG)	NS	--	--	NS	--	--	NS	--	--	NS	--	--	
Total Eubacteria (EBAC)	NS	--	--	NS	--	--	NS	--	--	NS	--	--	
trans-1,2-DCE Reductase (TDR)	NS	--	--	NS	--	--	NS	--	--	NS	--	--	
Trichlorobenzene Dioxygenase (TCBO)	NS	--	--	NS	--	--	NS	--	--	NS	--	--	
Vinyl Chloride Reductase (VCR)	NS	--	--	NS	--	--	NS	--	--	NS	--	--	
EDB (µg/L) EPA Method 8011	1,2-DIBROMOETHANE	NS	--	--	NS	--	--	NS	--	--	71.6		1.89
VFAs (mg/L) EPA Method 300m	ACETIC ACID	NS	--	--	NS	--	--	NS	--	--	ND	U	1
	BUTYRIC ACID	NS	--	--	NS	--	--	NS	--	--	ND	U	1
	FORMIC ACID	NS	--	--	NS	--	--	NS	--	--	ND	U	1
	LACTIC ACID	NS	--	--	NS	--	--	NS	--	--	ND	U	1
	PROPIONIC ACID	NS	--	--	NS	--	--	NS	--	--	ND	U	1
	PYRUVIC ACID	NS	--	--	NS	--	--	NS	--	--	ND	U	1
	VALERIC ACID	NS	--	--	NS	--	--	NS	--	--	ND	U	1
Fluorometric (µg/L) Spectrofluorophotometry	FLUORESCEIN	4.089		0.01	20.097		0.01	NS	--	--	8.078		0.01
Reduced Gases (µg/L) RSKSOP-175	ACETYLENE	NS	--	--	NS	--	--	NS	--	--	ND	U	10
	ETHANE	NS	--	--	NS	--	--	NS	--	--	ND	U	4
	ETHYLENE	NS	--	--	NS	--	--	NS	--	--	ND	U	5
	METHANE	NS	--	--	NS	--	--	NS	--	--	ND	U	2
	PROPANE	NS	--	--	NS	--	--	NS	--	--	ND	U	6
General Chemistry (mg/L) SM2320b, EPA Method 300, EPA Method 353.2, SM4500 Pec	ALKALINITY	NS	--	--	NS	--	--	NS	--	--	328		1
	BROMIDE	NS	--	--	NS	--	--	NS	--	--	0.546		0.125
	CHLORIDE	NS	--	--	NS	--	--	NS	--	--	45.9		0.33
	IODIDE	NS	--	--	NS	--	--	NS	--	--	ND	U	0.75
	NITRATE	NS	--	--	NS	--	--	NS	--	--	NA	--	--
	NITRITE	NS	--	--	NS	--	--	NS	--	--	NA	--	--
	NITROGEN, NITRATE-NITRITE	NS	--	--	NS	--	--	NS	--	--	ND	U	0.375
	O-PHOSPHATE (AS P)	NS	--	--	NS	--	--	NS	--	--	ND	U	0.02
	ORTHOPHOSPHATE	NS	--	--	NS	--	--	NS	--	--	NA	--	--
	PHOSPHORUS	NS	--	--	NS	--	--	NS	--	--	NA	--	--
SULFATE	NS	--	--	NS	--	--	NS	--	--	15.4		1	

Table 14
Analytical Data Table for KAFB-106MW2-I

Phase Designation		Phase 1 Recirculation											
Sample ID		106MW2I-P1R-101617			106MW2I-P1R-102017			106MW2I-P1R-102017-FD			106MW2I-P1R-102517		
Sample Date		10/16/2017			10/20/2017			10/20/2017			10/25/2017		
Sample Purpose		REG			REG			FD			REG		
Chemical Class and Analytical Method ^a	Parameter	Result	Val Qual	LOQ	Result	Val Qual	LOQ	Result	Val Qual	LOQ	Result	Val Qual	LOQ
Metals (mg/L) EPA Method 6010	LEAD	NS	--	--	NS	--	--	NS	--	--	NS	--	--
Dissolved Metals (mg/L) EPA Method 6010	IRON	NS	--	--	NS	--	--	NS	--	--	10.4		0.06
	MANGANESE	NS	--	--	NS	--	--	NS	--	--	1.74		0.006
δ ² H (‰) Mass Spectrometry, USGS Reston, VA	DELTA2H	-90.22		-99	-80.81		-99	-81.53		-99	-88.07		-99
VOCs (µg/L) EPA Method 8260	1,1,2-TRICHLOROETHANE	NS	--	--	NS	--	--	NS	--	--	ND	U	25
	1,2,4-TRICHLOROBENZENE	NS	--	--	NS	--	--	NS	--	--	NA	--	--
	1,2,4-TRIMETHYLBENZENE	NS	--	--	NS	--	--	NS	--	--	183		25
	1,2-DIBROMOETHANE	NS	--	--	NS	--	--	NS	--	--	72.6		25
	1,2-DICHLOROETHANE	NS	--	--	NS	--	--	NS	--	--	ND	U	25
	1,3,5-TRIMETHYLBENZENE	NS	--	--	NS	--	--	NS	--	--	65.2		25
	2-BUTANONE	NS	--	--	NS	--	--	NS	--	--	130	J	250
	2-CHLOROTOLUENE	NS	--	--	NS	--	--	NS	--	--	ND	U	25
	2-HEXANONE	NS	--	--	NS	--	--	NS	--	--	148	J	125
	4-METHYL-2-PENTANONE	NS	--	--	NS	--	--	NS	--	--	107	J	125
	ACETONE	NS	--	--	NS	--	--	NS	--	--	724		250
	BENZENE	NS	--	--	NS	--	--	NS	--	--	2290		25
	CARBON DISULFIDE	NS	--	--	NS	--	--	NS	--	--	ND	U	25
	CHLOROMETHANE	NS	--	--	NS	--	--	NS	--	--	ND	U	25
	CIS-1,2-DICHLOROETHENE	NS	--	--	NS	--	--	NS	--	--	NA	--	--
	DICHLORODIFLUOROMETHANE	NS	--	--	NS	--	--	NS	--	--	ND	U	50
	ETHYLBENZENE	NS	--	--	NS	--	--	NS	--	--	361		25
	ISOPROPYLBENZENE	NS	--	--	NS	--	--	NS	--	--	32.9	J	25
	M,P-XYLENES	NS	--	--	NS	--	--	NS	--	--	NA	--	--
	METHYL TERT-BUTYL ETHER	NS	--	--	NS	--	--	NS	--	--	ND	U	25
	METHYLENE CHLORIDE	NS	--	--	NS	--	--	NS	--	--	ND	U	50
	NAPHTHALENE	NS	--	--	NS	--	--	NS	--	--	77.1		25
	N-BUTYLBENZENE	NS	--	--	NS	--	--	NS	--	--	ND	U	25
	N-PROPYLBENZENE	NS	--	--	NS	--	--	NS	--	--	30.8	J	25
	O-XYLENE	NS	--	--	NS	--	--	NS	--	--	NA	--	--
	P-ISOPROPYLTOLUENE	NS	--	--	NS	--	--	NS	--	--	ND	U	25
	SEC-BUTYLBENZENE	NS	--	--	NS	--	--	NS	--	--	ND	U	25
	TERT-BUTYLBENZENE	NS	--	--	NS	--	--	NS	--	--	ND	U	25
	TETRACHLOROETHENE	NS	--	--	NS	--	--	NS	--	--	NA	--	--
	TOLUENE	NS	--	--	NS	--	--	NS	--	--	3310		25
	TRANS-1,2-DICHLOROETHENE	NS	--	--	NS	--	--	NS	--	--	NA	--	--
	TRICHLOROETHENE	NS	--	--	NS	--	--	NS	--	--	ND	U	25
	TRICHLOROFUOROMETHANE	NS	--	--	NS	--	--	NS	--	--	ND	U	50
	VINYL CHLORIDE	NS	--	--	NS	--	--	NS	--	--	NA	--	--
	XYLENES	NS	--	--	NS	--	--	NS	--	--	1860		75

Refer to notes at the end of the table.

Table 14
Analytical Data Table for KAFB-106MW2-I

Phase Designation		Phase 1 Recirculation			Phase 1 Passive			Phase 1 Passive			Phase 1 Passive		
Sample ID		106MW2I-P1R-110117			106MW2I-P1P-111517			106MW2I-P1P-112917			106MW2I-P1P-112917-FD		
Sample Date		11/1/2017			11/15/2017			11/29/2017			11/29/2017		
Sample Purpose		REG			REG			REG			FD		
Chemical Class and Analytical Method ^a	Parameter	Result	Val Qual	LOQ	Result	Val Qual	LOQ	Result	Val Qual	LOQ	Result	Val Qual	LOQ
Microbial Community (cells/mL) QuantArray-Chlor	1,1 DCA Reductase (DCA)	NS	--	--	NS	--	--	ND	U	5.1	NS	--	--
	1,2 DCA Reductase (DCAR)	NS	--	--	NS	--	--	ND	U	5.1	NS	--	--
	BAV1 Vinyl Chloride Reductase (BVC)	NS	--	--	NS	--	--	ND	U	0.5	NS	--	--
	cer A Reductase	NS	--	--	NS	--	--	NA	--	--	NS	--	--
	Chloroform Reductase (CFR)	NS	--	--	NS	--	--	ND	U	5.1	NS	--	--
	Dehalobacter DCM (DCM)	NS	--	--	NS	--	--	ND	U	5.1	NS	--	--
	Dehalobacter spp. (DHBT)	NS	--	--	NS	--	--	406000		5.1	NS	--	--
	Dehalobium chloroocercia (DECO)	NS	--	--	NS	--	--	24200		5.1	NS	--	--
	Dehalococcoides (DHC)	NS	--	--	NS	--	--	ND	U	0.5	NS	--	--
	Dehalogenimonas spp. (DHG)	NS	--	--	NS	--	--	ND	U	5.1	NS	--	--
	Desulfitobacterium spp. (DSB)	NS	--	--	NS	--	--	327000		5.1	NS	--	--
	Desulfuromonas spp. (DSM)	NS	--	--	NS	--	--	37.4		5.1	NS	--	--
	Dichloromethane Dehalogenase (DCMA)	NS	--	--	NS	--	--	ND	U	5.1	NS	--	--
	Epoxyalkane Transferase (EtnE)	NS	--	--	NS	--	--	ND	U	5.1	NS	--	--
	Ethene Monooxygenase (EtnC)	NS	--	--	NS	--	--	ND	U	5.1	NS	--	--
	Methanogens (MGN)	NS	--	--	NS	--	--	19.1		5.1	NS	--	--
	PCE Reductase (PCE-1)	NS	--	--	NS	--	--	NA	--	--	NS	--	--
	Phenol Hydroxylase (PHE)	NS	--	--	NS	--	--	5820		5.1	NS	--	--
	PMMO	NS	--	--	NS	--	--	ND	U	5.1	NS	--	--
	Soluble Methane Monooxygenase (SMMO)	NS	--	--	NS	--	--	1030		5.1	NS	--	--
	Sulfate Reducing Bacteria (APS)	NS	--	--	NS	--	--	178000		5.1	NS	--	--
	tceA Reductase (TCE)	NS	--	--	NS	--	--	ND	U	0.5	NS	--	--
	Toluene Dioxygenase (TOD)	NS	--	--	NS	--	--	ND	U	5.1	NS	--	--
	Toluene Monooxygenase (RMO)	NS	--	--	NS	--	--	10300		5.1	NS	--	--
Toluene Monooxygenase 2 (RDEG)	NS	--	--	NS	--	--	2860		5.1	NS	--	--	
Total Eubacteria (EBAC)	NS	--	--	NS	--	--	6550000		5.1	NS	--	--	
trans-1,2-DCE Reductase (TDR)	NS	--	--	NS	--	--	NA	--	--	NS	--	--	
Trichlorobenzene Dioxygenase (TCBO)	NS	--	--	NS	--	--	ND	U	5.1	NS	--	--	
Vinyl Chloride Reductase (VCR)	NS	--	--	NS	--	--	ND	U	0.5	NS	--	--	
EDB (µg/L) EPA Method 8011	1,2-DIBROMOETHANE	NS	--	--	33.7		3.83	20.1		1.91	17.1		1.9
VFAs (mg/L) EPA Method 300m	ACETIC ACID	NS	--	--	12.1		1	20.5		1	17.6		1
	BUTYRIC ACID	NS	--	--	ND	U	1	ND	U	1	ND	U	1
	FORMIC ACID	NS	--	--	ND	U	1	ND	U	1	ND	U	1
	LACTIC ACID	NS	--	--	ND	U	1	ND	U	1	ND	U	1
	PROPIONIC ACID	NS	--	--	ND	U	1	ND	U	1	ND	U	1
	PYRUVIC ACID	NS	--	--	ND	U	1	ND	U	1	ND	U	1
Fluorometric (µg/L) Spectrofluorophotometry	VALERIC ACID	NS	--	--	ND	U	1	ND	U	1	ND	U	1
	FLUORESCEIN	8.207		0.01	12.564		0.01	7.694		0.01	NS	--	--
Reduced Gases (µg/L) RSKSOP-175	ACETYLENE	NS	--	--	ND	U	10	ND	U	10	ND	U	10
	ETHANE	NS	--	--	ND	U	4	ND	U	4	ND	U	4
	ETHYLENE	NS	--	--	2.3	J	5	2.24	J	5	1.99	J	5
	METHANE	NS	--	--	2.61	J	2	17.2		2	16.3		2
	PROPANE	NS	--	--	ND	U	6	ND	U	6	ND	U	6
General Chemistry (mg/L) SM2320b, EPA Method 300, EPA Method 353.2, SM4500 Pec	ALKALINITY	NS	--	--	323		1	260		1	274		1
	BROMIDE	NS	--	--	0.599		0.125	0.599		0.125	0.6		0.125
	CHLORIDE	NS	--	--	44.1		0.33	42.9		0.33	42.8		0.33
	IODIDE	NS	--	--	ND	U	0.75	ND	U	0.75	ND	U	0.75
	NITRATE	NA	--	--	NA	--	--	NA	--	--	NA	--	--
	NITRITE	NA	--	--	NA	--	--	NA	--	--	NA	--	--
	NITROGEN, NITRATE-NITRITE	NS	--	--	ND	U	0.375	ND	U	0.375	ND	U	0.375
	O-PHOSPHATE (AS P)	NS	--	--	0.019	J	0.02	ND	U	0.02	ND	U	0.02
	ORTHOPHOSPHATE	NA	--	--	NA	--	--	NA	--	--	NA	--	--
	PHOSPHORUS	NA	--	--	NA	--	--	NA	--	--	NA	--	--
SULFATE	NS	--	--	2.98		1	2.37	J	1	2.42	J	1	

Table 14
Analytical Data Table for KAFB-106MW2-I

Phase Designation		Phase 1 Recirculation			Phase 1 Passive			Phase 1 Passive			Phase 1 Passive		
Sample ID		106MW2I-P1R-110117			106MW2I-P1P-111517			106MW2I-P1P-112917			106MW2I-P1P-112917-FD		
Sample Date		11/1/2017			11/15/2017			11/29/2017			11/29/2017		
Sample Purpose		REG			REG			REG			FD		
Chemical Class and Analytical Method ^a	Parameter	Result	Val Qual	LOQ	Result	Val Qual	LOQ	Result	Val Qual	LOQ	Result	Val Qual	LOQ
Metals (mg/L) EPA Method 6010	LEAD	NS	--	--	NS	--	--	NS	--	--	NS	--	--
Dissolved Metals (mg/L) EPA Method 6010	IRON	NS	--	--	18.7		0.06	18.3		0.06	17.8		0.06
	MANGANESE	NS	--	--	2.95		0.006	2.81		0.006	2.76		0.006
δ2H (‰) Mass Spectrometry, USGS Reston, VA	DELTA2H	-84.91		-99	-82.97		-99	-87.37		-99	-87.91		-99
VOCs (µg/L) EPA Method 8260	1,1,2-TRICHLOROETHANE	NS	--	--	ND	U	5	ND	U	2.5	ND	U	2.5
	1,2,4-TRICHLOROBENZENE	NS	--	--	NA	--	--	NA	--	--	NA	--	--
	1,2,4-TRIMETHYLBENZENE	NS	--	--	115		5	54.9		2.5	57.7		2.5
	1,2-DIBROMOETHANE	NS	--	--	40.2		5	21.7		2.5	22.3		2.5
	1,2-DICHLOROETHANE	NS	--	--	2.69	J	5	1.72	J	2.5	1.93	J	2.5
	1,3,5-TRIMETHYLBENZENE	NS	--	--	50		5	28.6		2.5	29.5		2.5
	2-BUTANONE	NS	--	--	43	J	50	16.6	J	25	16.8	J	25
	2-CHLOROTOLUENE	NS	--	--	ND	U	5	ND	U	2.5	ND	U	2.5
	2-HEXANONE	NS	--	--	87.4		25	31.1		12.5	34.6		12.5
	4-METHYL-2-PENTANONE	NS	--	--	64.1		25	32.6		12.5	34		12.5
	ACETONE	NS	--	--	228		50	97.2		25	104		25
	BENZENE	NS	--	--	1060		5	410		2.5	411		2.5
	CARBON DISULFIDE	NS	--	--	ND	U	5	ND	U	2.5	ND	U	2.5
	CHLOROMETHANE	NS	--	--	ND	U	5	ND	U	2.5	ND	U	2.5
	CIS-1,2-DICHLOROETHENE	NS	--	--	NA	--	--	NA	--	--	NA	--	--
	DICHLORODIFLUOROMETHANE	NS	--	--	ND	U	10	ND	U	5	ND	U	5
	ETHYLBENZENE	NS	--	--	166		5	31.3		2.5	32.5		2.5
	ISOPROPYLBENZENE	NS	--	--	23.9		5	16.2		2.5	16.9		2.5
	M,P-XYLENES	NS	--	--	NA	--	--	NA	--	--	NA	--	--
	METHYL TERT-BUTYL ETHER	NS	--	--	ND	U	5	ND	U	2.5	ND	U	2.5
	METHYLENE CHLORIDE	NS	--	--	ND	U	10	ND	U	5	ND	U	5
	NAPHTHALENE	NS	--	--	59.7		5	29		2.5	31.9		2.5
	N-BUTYLBENZENE	NS	--	--	4.6	J	5	1.72	J	2.5	1.89	J	2.5
	N-PROPYLBENZENE	NS	--	--	16.7		5	3.59	J	2.5	4.06	J	2.5
	O-XYLENE	NS	--	--	NA	--	--	NA	--	--	NA	--	--
	P-ISOPROPYLTOLUENE	NS	--	--	56.1		5	47		2.5	49.3		2.5
	SEC-BUTYLBENZENE	NS	--	--	5.14	J	5	1.55	J	2.5	1.67	J	2.5
	TERT-BUTYLBENZENE	NS	--	--	ND	U	5	ND	U	2.5	ND	U	2.5
	TETRACHLOROETHENE	NS	--	--	NA	--	--	NA	--	--	NA	--	--
	TOLUENE	NS	--	--	336		5	62.6		2.5	63.9		2.5
	TRANS-1,2-DICHLOROETHENE	NS	--	--	NA	--	--	NA	--	--	NA	--	--
	TRICHLOROETHENE	NS	--	--	ND	U	5	ND	U	2.5	ND	U	2.5
	TRICHLOROFUOROMETHANE	NS	--	--	ND	U	10	ND	U	5	ND	U	5
	VINYL CHLORIDE	NS	--	--	NA	--	--	NA	--	--	NA	--	--
	XYLENES	NS	--	--	1270		15	760		7.5	773		7.5

Refer to notes at the end of the table.

Table 14
Analytical Data Table for KAFB-106MW2-I

Phase Designation		Phase 2 Recirculation									Phase 2 Passive		
Sample ID		106MW2I-P2R-010918			106MW2I-P2R-011818			106MW2I-P2R-012418			106MW2I-P2P-030618		
Sample Date		1/9/2018			1/18/2018			1/24/2018			3/6/2018		
Sample Purpose		REG			REG			REG			REG		
Chemical Class and Analytical Method ^a	Parameter	Result	Val Qual	LOQ	Result	Val Qual	LOQ	Result	Val Qual	LOQ	Result	Val Qual	LOQ
Microbial Community (cells/mL) QuantArray-Chlor	1,1 DCA Reductase (DCA)	NS	--	--	NS	--	--	ND	U	5	NS	--	--
	1,2 DCA Reductase (DCAR)	NS	--	--	NS	--	--	ND	U	5	NS	--	--
	BAV1 Vinyl Chloride Reductase (BVC)	NS	--	--	NS	--	--	ND	U	0.5	NS	--	--
	cer A Reductase	NS	--	--	NS	--	--	ND	U	5	NS	--	--
	Chloroform Reductase (CFR)	NS	--	--	NS	--	--	ND	U	5	NS	--	--
	Dehalobacter DCM (DCM)	NS	--	--	NS	--	--	ND	U	5	NS	--	--
	Dehalobacter spp. (DHBT)	NS	--	--	NS	--	--	306000		5	NS	--	--
	Dehalobium chlorocoercia (DECO)	NS	--	--	NS	--	--	36400		5	NS	--	--
	Dehalococcoides (DHC)	NS	--	--	NS	--	--	ND	U	0.5	NS	--	--
	Dehalogenimonas spp. (DHG)	NS	--	--	NS	--	--	ND	U	5	NS	--	--
	Desulfobacterium spp. (DSB)	NS	--	--	NS	--	--	147000		5	NS	--	--
	Desulfuromonas spp. (DSM)	NS	--	--	NS	--	--	156		5	NS	--	--
	Dichloromethane Dehalogenase (DCMA)	NS	--	--	NS	--	--	ND	U	5	NS	--	--
	Epoxyalkane Transferase (EtnE)	NS	--	--	NS	--	--	ND	U	5	NS	--	--
	Ethene Monooxygenase (EtnC)	NS	--	--	NS	--	--	107		5	NS	--	--
	Methanogens (MGN)	NS	--	--	NS	--	--	107		5	NS	--	--
	PCE Reductase (PCE-1)	NS	--	--	NS	--	--	ND	U	5	NS	--	--
	Phenol Hydroxylase (PHE)	NS	--	--	NS	--	--	21600		5	NS	--	--
	PMMO	NS	--	--	NS	--	--	NA	--	--	NS	--	--
	Soluble Methane Monooxygenase (SMMO)	NS	--	--	NS	--	--	ND	U	5	NS	--	--
	Sulfate Reducing Bacteria (APS)	NS	--	--	NS	--	--	157000		5	NS	--	--
	tceA Reductase (TCE)	NS	--	--	NS	--	--	ND	U	0.5	NS	--	--
	Toluene Dioxygenase (TOD)	NS	--	--	NS	--	--	ND	U	5	NS	--	--
	Toluene Monooxygenase (RMO)	NS	--	--	NS	--	--	73000		5	NS	--	--
Toluene Monooxygenase 2 (RDEG)	NS	--	--	NS	--	--	15700		5	NS	--	--	
Total Eubacteria (EBAC)	NS	--	--	NS	--	--	5230000		5	NS	--	--	
trans-1,2-DCE Reductase (TDR)	NS	--	--	NS	--	--	ND	U	5	NS	--	--	
Trichlorobenzene Dioxygenase (TCBO)	NS	--	--	NS	--	--	ND	U	5	NS	--	--	
Vinyl Chloride Reductase (VCR)	NS	--	--	NS	--	--	ND	U	0.5	NS	--	--	
EDB (µg/L) EPA Method 8011	1,2-DIBROMOETHANE	39.2		1.9	37.1		1.88	31.3		1.9	1.98	J+	0.192
VFAs (mg/L) EPA Method 300m	ACETIC ACID	45.2	J	1	22.1		1	51.5		1	26.8		1
	BUTYRIC ACID	ND	U	1	ND	U	1	ND	U	1	ND	U	1
	FORMIC ACID	ND	U	1	ND	U	1	ND	U	1	ND	U	1
	LACTIC ACID	1.33	J-	1	0.57	J	1	ND	U	1	1.31		1
	PROPIONIC ACID	14.9	J	1	5.95		1	19.3		1	1		1
	PYRUVIC ACID	ND	U	1	ND	U	1	ND	U	1	ND	U	1
Fluorometric (µg/L) Spectrofluorophotometry	VALERIC ACID	ND	U	1	ND	U	1	ND	U	1	ND	U	1
	FLUORESCEIN	NS	--	--	NS	--	--	NS	--	--	NS	--	--
Reduced Gases (µg/L) RSKSOP-175	ACETYLENE	ND	U	10	ND	U	10	ND	U	10	ND	U	10
	ETHANE	1.08	J	4	1.06		4	1.31	J	4	0.51	J	4
	ETHYLENE	5.62		5	4.51	J	5	5.43		5	2.84	J	5
	METHANE	3.42		2	2.88		2	4.56		2	211		2
	PROPANE	1.21	J	6	ND	U	6	1.47	J	6	ND	U	6
General Chemistry (mg/L) SM2320b, EPA Method 300, EPA Method 353.2, SM4500 Pec	ALKALINITY	305		1	334		1	342		1	277		1
	BROMIDE	0.544		0.25	0.685		0.25	0.547		0.25	0.251		0.125
	CHLORIDE	52.9		0.66	57.3	J+	0.66	47.1		0.66	26.4		0.33
	IODIDE	5.5		0.75	6		0.75	7.3		0.75	2.2		0.75
	NITRATE	NA	--	--	NA	--	--	NA	--	--	NA	--	--
	NITRITE	NA	--	--	NA	--	--	NA	--	--	NA	--	--
	NITROGEN, NITRATE-NITRITE	ND	U	0.375	ND	U	0.375	ND	U	0.375	ND	U	0.375
	O-PHOSPHATE (AS P)	ND	U	0.02	0.0136	J	0.02	ND	U	0.02	ND	U	0.02
	ORTHOPHOSPHATE	NA	--	--	NA	--	--	NA	--	--	NA	--	--
	PHOSPHORUS	NA	--	--	NA	--	--	NA	--	--	NA	--	--
SULFATE	ND	U	2	ND	U	2	ND	U	2	1.77	J	1	

Table 14
Analytical Data Table for KAFB-106MW2-I

Phase Designation		Phase 2 Recirculation									Phase 2 Passive		
Sample ID		106MW2I-P2R-010918			106MW2I-P2R-011818			106MW2I-P2R-012418			106MW2I-P2P-030618		
Sample Date		1/9/2018			1/18/2018			1/24/2018			3/6/2018		
Sample Purpose		REG			REG			REG			REG		
Chemical Class and Analytical Method ^a	Parameter	Result	Val Qual	LOQ	Result	Val Qual	LOQ	Result	Val Qual	LOQ	Result	Val Qual	LOQ
Metals (mg/L) EPA Method 6010	LEAD	NS	--	--	NS	--	--	NS	--	--	NS	--	--
Dissolved Metals (mg/L) EPA Method 6010	IRON	22.1		0.06	20.7		0.06	20.4	J-	0.06	12.3		0.06
	MANGANESE	3.75		0.006	3.73		0.006	3.32	J-	0.006	1.92		0.006
δ2H (‰) Mass Spectrometry, USGS Reston, VA	DELTA2H	NS	--	--	NS	--	--	NS	--	--	NS	--	--
VOCs (µg/L) EPA Method 8260	1,1,2-TRICHLOROETHANE	ND	U	12.5	ND	U	25	ND	U	25	ND	U	5
	1,2,4-TRICHLOROBENZENE	NA	--	--	NA	--	--	NA	--	--	NA	--	--
	1,2,4-TRIMETHYLBENZENE	143		12.5	130		25	220		25	38.7		5
	1,2-DIBROMOETHANE	40.7		12.5	31.1	J	25	25.9	J	25	ND	U	5
	1,2-DICHLOROETHANE	ND	U	12.5	ND	U	25	ND	U	25	ND	U	5
	1,3,5-TRIMETHYLBENZENE	83.2		12.5	70		25	94.3		25	23.9		5
	2-BUTANONE	ND	U	125	ND	U	250	ND	U	250	ND	U	50
	2-CHLOROTOLUENE	ND	U	12.5	ND	U	25	ND	U	25	ND	U	5
	2-HEXANONE	60.6	J	62.5	79.4	J	125	86.7	J	125	14.9	J+	25
	4-METHYL-2-PENTANONE	48.4	J	62.5	68.2	J	125	72.4	J	125	13.6	J	25
	ACETONE	163	J	125	257	J	250	239	J	250	48.5	J+	50
	BENZENE	1720		12.5	2300		25	3270		25	427		5
	CARBON DISULFIDE	ND	U	12.5	ND	U	25	ND	U	25	ND	U	5
	CHLOROMETHANE	ND	U	12.5	ND	U	25	ND	U	25	ND	U	5
	CIS-1,2-DICHLOROETHENE	NA	--	--	NA	--	--	NA	--	--	NA	--	--
	DICHLORODIFLUOROMETHANE	ND	U	25	ND	U	50	ND	U	50	ND	U	10
	ETHYLBENZENE	354		12.5	383		25	491		25	89.8		5
	ISOPROPYLBENZENE	50.2		12.5	66.2		25	89.1		25	44.6		5
	M,P-XYLENES	NA	--	--	NA	--	--	NA	--	--	NA	--	--
	METHYL TERT-BUTYL ETHER	ND	U	12.5	ND	U	25	ND	U	25	ND	U	5
	METHYLENE CHLORIDE	ND	U	25	ND	U	50	ND	U	50	ND	U	10
	NAPHTHALENE	62.7		12.5	72.5		25	72.9		25	17.5		5
	N-BUTYLBENZENE	8.28	J	12.5	ND	U	25	ND	U	25	2.71	J	5
	N-PROPYLBENZENE	29.5		12.5	37.7	J	25	49.4	J	25	8.66	J	5
	O-XYLENE	NA	--	--	NA	--	--	NA	--	--	NA	--	--
	P-ISOPROPYLTOLUENE	126		12.5	111		25	121		25	ND	U	5
	SEC-BUTYLBENZENE	8.17	J	12.5	ND	U	25	ND	U	25	2.52	J	5
	TERT-BUTYLBENZENE	ND	U	12.5	ND	U	25	ND	U	25	ND	U	5
	TETRACHLOROETHENE	NA	--	--	NA	--	--	NA	--	--	NA	--	--
	TOLUENE	2670		12.5	3570		25	3840		25	217		5
	TRANS-1,2-DICHLOROETHENE	NA	--	--	NA	--	--	NA	--	--	NA	--	--
	TRICHLOROETHENE	ND	U	12.5	ND	U	25	ND	U	25	ND	U	5
	TRICHLOROFUOROMETHANE	ND	U	25	ND	U	50	ND	U	50	ND	U	10
	VINYL CHLORIDE	NA	--	--	NA	--	--	NA	--	--	NA	--	--
	XYLENES	1410		37.5	1580		75	1900		75	356		15

Refer to notes at the end of the table.

Table 14
Analytical Data Table for KAFB-106MW2-I

Phase Designation		Phase 2 Passive											
Sample ID		106MW2I-P2P-030618-FD			106MW2I-P2P-041118			106MW2I-P2P-050818			106MW2I-P2P-061218		
Sample Date		3/6/2018			4/11/2018			5/8/2018			6/12/2018		
Sample Purpose		FD			REG			REG			REG		
Chemical Class and Analytical Method ^a	Parameter	Result	Val Qual	LOQ	Result	Val Qual	LOQ	Result	Val Qual	LOQ	Result	Val Qual	LOQ
Microbial Community (cells/mL) QuantArray-Chlor	1,1 DCA Reductase (DCA)	NS	--	--	NS	--	--	ND	U	4.9	NS	--	--
	1,2 DCA Reductase (DCAR)	NS	--	--	NS	--	--	ND	U	4.9	NS	--	--
	BAV1 Vinyl Chloride Reductase (BVC)	NS	--	--	NS	--	--	ND	U	0.5	NS	--	--
	cer A Reductase	NS	--	--	NS	--	--	3.9	J	4.9	NS	--	--
	Chloroform Reductase (CFR)	NS	--	--	NS	--	--	ND	U	4.9	NS	--	--
	Dehalobacter DCM (DCM)	NS	--	--	NS	--	--	299		4.9	NS	--	--
	Dehalobacter spp. (DHBT)	NS	--	--	NS	--	--	174000		4.9	NS	--	--
	Dehalobium chlorocoercia (DECO)	NS	--	--	NS	--	--	6240		4.9	NS	--	--
	Dehalococcoides (DHC)	NS	--	--	NS	--	--	ND	U	0.5	NS	--	--
	Dehalogenimonas spp. (DHG)	NS	--	--	NS	--	--	ND	U	4.9	NS	--	--
	Desulfobacterium spp. (DSB)	NS	--	--	NS	--	--	25500		4.9	NS	--	--
	Desulfuromonas spp. (DSM)	NS	--	--	NS	--	--	18.4		4.9	NS	--	--
	Dichloromethane Dehalogenase (DCMA)	NS	--	--	NS	--	--	ND	U	4.9	NS	--	--
	Epoxyalkane Transferase (EtnE)	NS	--	--	NS	--	--	219		4.9	NS	--	--
	Ethene Monooxygenase (EtnC)	NS	--	--	NS	--	--	ND	U	4.9	NS	--	--
	Methanogens (MGN)	NS	--	--	NS	--	--	10700		4.9	NS	--	--
	PCE Reductase (PCE-1)	NS	--	--	NS	--	--	ND	U	4.9	NS	--	--
	Phenol Hydroxylase (PHE)	NS	--	--	NS	--	--	3120		4.9	NS	--	--
	PMMO	NS	--	--	NS	--	--	NA	--	--	NS	--	--
	Soluble Methane Monooxygenase (SMMO)	NS	--	--	NS	--	--	ND	U	4.9	NS	--	--
	Sulfate Reducing Bacteria (APS)	NS	--	--	NS	--	--	189000		4.9	NS	--	--
	tceA Reductase (TCE)	NS	--	--	NS	--	--	ND	U	0.5	NS	--	--
	Toluene Dioxygenase (TOD)	NS	--	--	NS	--	--	ND	U	4.9	NS	--	--
	Toluene Monooxygenase (RMO)	NS	--	--	NS	--	--	24500		4.9	NS	--	--
Toluene Monooxygenase 2 (RDEG)	NS	--	--	NS	--	--	5880		4.9	NS	--	--	
Total Eubacteria (EBAC)	NS	--	--	NS	--	--	4360000		4.9	NS	--	--	
trans-1,2-DCE Reductase (TDR)	NS	--	--	NS	--	--	ND	U	4.9	NS	--	--	
Trichlorobenzene Dioxygenase (TCBO)	NS	--	--	NS	--	--	ND	U	4.9	NS	--	--	
Vinyl Chloride Reductase (VCR)	NS	--	--	NS	--	--	ND	U	0.5	NS	--	--	
EDB (µg/L) EPA Method 8011	1,2-DIBROMOETHANE	1.61	J+	0.188	1.08	J	0.0382	1.35		0.0378	2.82		0.192
VFAs (mg/L) EPA Method 300m	ACETIC ACID	16.8		1	20.4		1	24.87		1	11.8		1
	BUTYRIC ACID	ND	U	1	ND	U	1	ND	U	1	ND	U	1
	FORMIC ACID	ND	U	1	ND	U	1	ND	U	1	ND	U	1
	LACTIC ACID	0.8	J	1	0.9	J	1	0.66	J	1	0.6	J	1
	PROPIONIC ACID	ND	U	1	1		1	ND	U	1	ND	U	1
	PYRUVIC ACID	ND	U	1	ND	U	1	ND	U	1	ND	U	1
Fluorometric (µg/L) Spectrofluorophotometry	VALERIC ACID	ND	U	1	ND	U	1	ND	U	1	ND	U	1
	FLUORESCCEIN	NS	--	--	NS	--	--	NS	--	--	NS	--	--
Reduced Gases (µg/L) RSKSOP-175	ACETYLENE	ND	U	10	ND	U	10	ND	U	10	ND	U	10
	ETHANE	ND	U	4	0.4	J	4	0.45	J	4	0.6	J	4
	ETHYLENE	3.2	J	5	3.11		5	3.07		5	2.1	J	5
	METHANE	220		2	767.8		2	1440		2	1560.2		2
	PROPANE	ND	U	6	ND	U	6	ND	U	6	0.9	J	6
General Chemistry (mg/L) SM2320b, EPA Method 300, EPA Method 353.2, SM4500 Pec	ALKALINITY	283		1	255		1	313		1	364		1
	BROMIDE	0.251		0.125	0.29		0.125	0.517		0.25	0.632		0.25
	CHLORIDE	26.5		0.33	31.3		0.33	47.7		0.66	56.8		0.66
	IODIDE	2.2		0.75	0.62	J	0.75	0.64	J	0.75	2.3		0.75
	NITRATE	NA	--	--	ND	U	0.1	ND	U	0.2	ND	U	0.2
	NITRITE	NA	--	--	ND	U	0.1	ND	U	0.2	ND	U	0.2
	NITROGEN, NITRATE-NITRITE	ND	U	0.375	NA	--	--	NA	--	--	NA	--	--
	O-PHOSPHATE (AS P)	ND	U	0.02	ND	U	0.02	0.0113	J	0.02	0.022		0.02
	ORTHOPHOSPHATE	NA	--	--	NA	--	--	NA	--	--	NA	--	--
	PHOSPHORUS	NA	--	--	NA	--	--	NA	--	--	NA	--	--
SULFATE	1.74	J	1	2.77		1	ND	U	2	ND	U	2	

Table 14
Analytical Data Table for KAFB-106MW2-I

Phase Designation		Phase 2 Passive											
Sample ID		106MW2I-P2P-030618-FD			106MW2I-P2P-041118			106MW2I-P2P-050818			106MW2I-P2P-061218		
Sample Date		3/6/2018			4/11/2018			5/8/2018			6/12/2018		
Sample Purpose		FD			REG			REG			REG		
Chemical Class and Analytical Method ^a	Parameter	Result	Val Qual	LOQ	Result	Val Qual	LOQ	Result	Val Qual	LOQ	Result	Val Qual	LOQ
Metals (mg/L) EPA Method 6010	LEAD	NS	--	--	NS	--	--	NS	--	--	NS	--	--
Dissolved Metals (mg/L) EPA Method 6010	IRON	11.5		0.06	8.55	J-	0.06	17.6		0.06	18.7		0.06
	MANGANESE	1.86		0.006	2.04	J+	0.006	3.29		0.006	3.8		0.006
δ2H (‰) Mass Spectrometry, USGS Reston, VA	DELTA2H	NS	--	--	NS	--	--	NS	--	--	NS	--	--
VOCs (µg/L) EPA Method 8260	1,1,2-TRICHLOROETHANE	ND	U	5	ND	U	1	ND	U	2.5	ND	U	1
	1,2,4-TRICHLOROBENZENE	NA	--	--	NA	--	--	NA	--	--	NA	--	--
	1,2,4-TRIMETHYLBENZENE	42.2		5	16.1		1	20.8		2.5	17.7		1
	1,2-DIBROMOETHANE	ND	U	5	1.37	J	1	2.53	J	2.5	3.56		1
	1,2-DICHLOROETHANE	ND	U	5	1.32	J	1	2.37	J	2.5	3.03		1
	1,3,5-TRIMETHYLBENZENE	25.6		5	16.3		1	30.9		2.5	30.7		1
	2-BUTANONE	ND	U	50	ND	U	10	ND	U	25	ND	U	10
	2-CHLOROTOLUENE	ND	U	5	ND	U	1	ND	U	2.5	ND	U	1
	2-HEXANONE	15	J+	25	2.85	J	5	ND	U	12.5	ND	U	5
	4-METHYL-2-PENTANONE	15.2	J	25	6.86	J	5	12.1	J	12.5	8.08	J	5
	ACETONE	36.3	J+	50	22	J+	10	38.6	J	25	21.5		10
	BENZENE	439		5	151		1	129		2.5	52.7		1
	CARBON DISULFIDE	ND	U	5	ND	U	1	ND	U	2.5	ND	U	1
	CHLOROMETHANE	ND	U	5	ND	U	1	ND	U	2.5	ND	U	1
	CIS-1,2-DICHLOROETHENE	NA	--	--	NA	--	--	NA	--	--	NA	--	--
	DICHLORODIFLUOROMETHANE	ND	U	10	ND	U	2	ND	U	5	ND	U	2
	ETHYLBENZENE	90.5		5	26.8		1	21.6		2.5	6.61		1
	ISOPROPYLBENZENE	45		5	57.7		1	130		2.5	137		1
	M,P-XYLENES	NA	--	--	NA	--	--	NA	--	--	NA	--	--
	METHYL TERT-BUTYL ETHER	ND	U	5	ND	U	1	ND	U	2.5	0.546	J	1
	METHYLENE CHLORIDE	ND	U	10	ND	U	2	ND	U	5	ND	U	2
	NAPHTHALENE	18.5		5	12.9		1	11.3		2.5	4.9		1
	N-BUTYLBENZENE	2.96	J	5	1.53	J	1	3.16	J	2.5	ND	U	1
	N-PROPYLBENZENE	8.99	J	5	3.49		1	4.66	J	2.5	1.78	J	1
	O-XYLENE	NA	--	--	NA	--	--	NA	--	--	NA	--	--
	P-ISOPROPYLTOLUENE	38.2		5	48.6		1	117		2.5	130		1
	SEC-BUTYLBENZENE	2.57	J	5	1.45	J	1	2.38	J	2.5	1.16	J	1
	TERT-BUTYLBENZENE	ND	U	5	ND	U	1	ND	U	2.5	ND	U	1
	TETRACHLOROETHENE	NA	--	--	NA	--	--	NA	--	--	NA	--	--
	TOLUENE	221		5	40.3		1	33		2.5	12.1		1
	TRANS-1,2-DICHLOROETHENE	NA	--	--	NA	--	--	NA	--	--	NA	--	--
	TRICHLOROETHENE	ND	U	5	ND	U	1	ND	U	2.5	ND	U	1
	TRICHLOROFUOROMETHANE	ND	U	10	ND	U	2	ND	U	5	ND	U	2
	VINYL CHLORIDE	NA	--	--	NA	--	--	NA	--	--	NA	--	--
	XYLENES	369		15	265		3	333		7.5	311		3

Refer to notes at the end of the table.

Table 14
Analytical Data Table for KAFB-106MW2-I

Phase Designation		Phase 3 Recirculation											
Sample ID		106MW2I-P3R-080718			106MW2I-P3R-081518			106MW2I-P3R-082118			106MW2I-P3R-082818		
Sample Date		8/7/2018			8/15/2018			8/21/2018			8/28/2018		
Sample Purpose		REG			REG			REG			REG		
Chemical Class and Analytical Method ^a	Parameter	Result	Val Qual	LOQ	Result	Val Qual	LOQ	Result	Val Qual	LOQ	Result	Val Qual	LOQ
Microbial Community (cells/mL) QuantArray-Chlor	1,1 DCA Reductase (DCA)	NS	--	--	NS	--	--	ND	U	5.1	NS	--	--
	1,2 DCA Reductase (DCAR)	NS	--	--	NS	--	--	ND	U	5.1	NS	--	--
	BAV1 Vinyl Chloride Reductase (BVC)	NS	--	--	NS	--	--	ND	U	0.5	NS	--	--
	cer A Reductase	NS	--	--	NS	--	--	ND	U	5.1	NS	--	--
	Chloroform Reductase (CFR)	NS	--	--	NS	--	--	ND	U	5.1	NS	--	--
	Dehalobacter DCM (DCM)	NS	--	--	NS	--	--	314		5.1	NS	--	--
	Dehalobacter spp. (DHBT)	NS	--	--	NS	--	--	107000		5.1	NS	--	--
	Dehalobium chlorocoercia (DECO)	NS	--	--	NS	--	--	6580		5.1	NS	--	--
	Dehalococcoides (DHC)	NS	--	--	NS	--	--	ND	U	0.5	NS	--	--
	Dehalogenimonas spp. (DHG)	NS	--	--	NS	--	--	ND	U	5.1	NS	--	--
	Desulfobacterium spp. (DSB)	NS	--	--	NS	--	--	23200		5.1	NS	--	--
	Desulfuromonas spp. (DSM)	NS	--	--	NS	--	--	ND	U	5.1	NS	--	--
	Dichloromethane Dehalogenase (DCMA)	NS	--	--	NS	--	--	ND	U	5.1	NS	--	--
	Epoxyalkane Transferase (EtnE)	NS	--	--	NS	--	--	ND	U	5.1	NS	--	--
	Ethene Monooxygenase (EtnC)	NS	--	--	NS	--	--	ND	U	5.1	NS	--	--
	Methanogens (MGN)	NS	--	--	NS	--	--	3500		5.1	NS	--	--
	PCE Reductase (PCE-1)	NS	--	--	NS	--	--	ND	U	5.1	NS	--	--
	Phenol Hydroxylase (PHE)	NS	--	--	NS	--	--	275		5.1	NS	--	--
	PMMO	NS	--	--	NS	--	--	NA	--	--	NS	--	--
	Soluble Methane Monooxygenase (SMMO)	NS	--	--	NS	--	--	ND	U	5.1	NS	--	--
	Sulfate Reducing Bacteria (APS)	NS	--	--	NS	--	--	94500		5.1	NS	--	--
	tceA Reductase (TCE)	NS	--	--	NS	--	--	ND	U	0.5	NS	--	--
	Toluene Dioxygenase (TOD)	NS	--	--	NS	--	--	ND	U	5.1	NS	--	--
	Toluene Monooxygenase (RMO)	NS	--	--	NS	--	--	5180		5.1	NS	--	--
Toluene Monooxygenase 2 (RDEG)	NS	--	--	NS	--	--	702		5.1	NS	--	--	
Total Eubacteria (EBAC)	NS	--	--	NS	--	--	4050000		5.1	NS	--	--	
trans-1,2-DCE Reductase (TDR)	NS	--	--	NS	--	--	ND	U	5.1	NS	--	--	
Trichlorobenzene Dioxygenase (TCBO)	NS	--	--	NS	--	--	ND	U	5.1	NS	--	--	
Vinyl Chloride Reductase (VCR)	NS	--	--	NS	--	--	ND	U	0.5	NS	--	--	
EDB (µg/L) EPA Method 8011	1,2-DIBROMOETHANE	NA	--	--	0.77		0.003	0.62		0.003	5.1		0.029
VFAs (mg/L) EPA Method 300m	ACETIC ACID	22.1		1	44.7		10	39.3		10	28.1		10
	BUTYRIC ACID	ND	U	1	ND	U	1	ND	U	1	ND	U	1
	FORMIC ACID	4	J	10	ND	U	1	ND	U	1	0.9	J	10
	LACTIC ACID	0.2	J	1	0.6	J	1	0.6	J	1	0.6	J	1
	PROPIONIC ACID	ND	U	1	4.5	J	10	5.6	J	10	10.3		10
	PYRUVIC ACID	ND	U	1	ND	U	1	ND	U	1	ND	U	1
Fluorometric (µg/L) Spectrofluorophotometry	VALERIC ACID	ND	U	1	ND	U	1	ND	U	1	ND	U	1
	FLUORESCCEIN	NS	--	--	NS	--	--	NS	--	--	NS	--	--
Reduced Gases (µg/L) RSKSOP-175	ACETYLENE	ND	U	10	ND	U	10	ND	U	10	ND	U	10
	ETHANE	0.9	J	4	1.2	J	4	1.4	J	4	1.6	J	4
	ETHYLENE	4.1	J	5	4	J	5	4.1	J	5	4.7	J	5
	METHANE	1028.2		2	1376.3		2	1683.1		2	2159.4		2
	PROPANE	1.1	J	6	1.3	J	6	1.4	J	6	1.5	J	6
General Chemistry (mg/L) SM2320b, EPA Method 300, EPA Method 353.2, SM4500 Pec	ALKALINITY	NA	--	--	350		5	380		5	390		5
	BROMIDE	NA	--	--	0.9		0.5	0.83		0.5	0.96		0.5
	CHLORIDE	NA	--	--	53		0.5	52		0.5	53		0.5
	IODIDE	8.1		0.75	6.9		0.75	8		0.75	10		0.75
	NITRATE	NA	--	--	NA	--	--	NA	--	--	NA	--	--
	NITRITE	NA	--	--	NA	--	--	NA	--	--	NA	--	--
	NITROGEN, NITRATE-NITRITE	NA	--	--	ND	U	0.05	ND		0.05	ND	U	0.05
	O-PHOSPHATE (AS P)	NA	--	--	NA	--	--	NA	--	--	NA	--	--
	ORTHOPHOSPHATE	NA	--	--	ND	U	0.15	ND		0.15	ND	U	0.15
	PHOSPHORUS	NA	--	--	NA	--	--	NA	--	--	NA	--	--
	SULFATE	NA	--	--	ND	U	1	ND		1	ND	U	1

Table 14
Analytical Data Table for KAFB-106MW2-I

Phase Designation		Phase 3 Recirculation											
Sample ID		106MW2I-P3R-080718			106MW2I-P3R-081518			106MW2I-P3R-082118			106MW2I-P3R-082818		
Sample Date		8/7/2018			8/15/2018			8/21/2018			8/28/2018		
Sample Purpose		REG			REG			REG			REG		
Chemical Class and Analytical Method ^a	Parameter	Result	Val Qual	LOQ	Result	Val Qual	LOQ	Result	Val Qual	LOQ	Result	Val Qual	LOQ
Metals (mg/L) EPA Method 6010	LEAD	NS	--	--	NS	--	--	NS	--	--	NS	--	--
Dissolved Metals (mg/L) EPA Method 6010	IRON	NA	--	--	15		0.05	14		0.05	15		0.05
	MANGANESE	NA	--	--	4.5		0.003	4.2		0.003	4.5		0.003
δ2H (‰) Mass Spectrometry, USGS Reston, VA	DELTA2H	NS	--	--	NS	--	--	NS	--	--	NS	--	--
VOCs (µg/L) EPA Method 8260	1,1,2-TRICHLOROETHANE	NA	--	--	ND	U	25	ND	U	5	ND	U	25
	1,2,4-TRICHLOROBENZENE	NA	--	--	NA	--	--	NA	--	--	NA	--	--
	1,2,4-TRIMETHYLBENZENE	NA	--	--	190		50	180		10	220		50
	1,2-DIBROMOETHANE	NA	--	--	ND	U	50	ND	U	10	ND	U	50
	1,2-DICHLOROETHANE	NA	--	--	ND	U	50	ND	U	10	ND	U	50
	1,3,5-TRIMETHYLBENZENE	NA	--	--	83		25	71		5	82		25
	2-BUTANONE	NA	--	--	ND	U	500	ND	U	100	ND	U	500
	2-CHLOROTOLUENE	NA	--	--	ND	U	25	ND	U	5	ND	U	25
	2-HEXANONE	NA	--	--	ND	U	250	48	J	50	ND	U	250
	4-METHYL-2-PENTANONE	NA	--	--	ND	U	250	53	J	50	ND	U	250
	ACETONE	NA	--	--	ND	U	500	100		100	ND	U	500
	BENZENE	NA	--	--	1700		50	1900		20	3100		50
	CARBON DISULFIDE	NA	--	--	ND	U	100	ND	U	20	ND	U	100
	CHLOROMETHANE	NA	--	--	ND	U	50	ND	U	10	ND	U	50
	CIS-1,2-DICHLOROETHENE	NA	--	--	NA	--	--	NA	--	--	NA	--	--
	DICHLORODIFLUOROMETHANE	NA	--	--	ND	U	50	ND	U	10	ND	U	50
	ETHYLBENZENE	NA	--	--	420		50	430		10	640		50
	ISOPROPYLBENZENE	NA	--	--	120		50	95		10	120		50
	M,P-XYLENES	NA	--	--	NA	--	--	NA	--	--	NA	--	--
	METHYL TERT-BUTYL ETHER	NA	--	--	ND	U	25	ND	U	5	ND	U	25
	METHYLENE CHLORIDE	NA	--	--	ND	U	250	ND	U	50	240	J	250
	NAPHTHALENE	NA	--	--	170	J	250	89		50	ND	U	250
	N-BUTYLBENZENE	NA	--	--	ND	U	50	6.8	J	10	ND	U	50
	N-PROPYLBENZENE	NA	--	--	49	J	50	37		10	50		50
	O-XYLENE	NA	--	--	NA	--	--	NA	--	--	NA	--	--
	P-ISOPROPYLTOLUENE	NA	--	--	140		50	90		10	97		50
	SEC-BUTYLBENZENE	NA	--	--	ND	U	50	7.6	J	10	ND	U	50
	TERT-BUTYLBENZENE	NA	--	--	ND	U	50	ND	U	10	ND	U	50
	TETRACHLOROETHENE	NA	--	--	NA	--	--	NA	--	--	NA	--	--
	TOLUENE	NA	--	--	2700		50	2000		20	3000		50
	TRANS-1,2-DICHLOROETHENE	NA	--	--	NA	--	--	NA	--	--	NA	--	--
	TRICHLOROETHENE	NA	--	--	ND	U	50	ND	U	10	ND	U	50
	TRICHLOROFUOROMETHANE	NA	--	--	ND	U	50	ND	U	10	ND	U	50
	VINYL CHLORIDE	NA	--	--	NA	--	--	NA	--	--	NA	--	--
	XYLENES	NA	--	--	1200		25	1200		5	1900		25

Refer to notes at the end of the table.

Table 14
Analytical Data Table for KAFB-106MW2-I

Phase Designation		Phase 3 Passive											
Sample ID		106MW2I-P3P-091118			106MW2I-P3P-100218			106MW2I-P3P-111518			106MW2I-P3P-111518-FD		
Sample Date		9/11/2018			10/2/2018			11/15/2018			11/15/2018		
Sample Purpose		REG			REG			REG			FD		
Chemical Class and Analytical Method ^a	Parameter	Result	Val Qual	LOQ	Result	Val Qual	LOQ	Result	Val Qual	LOQ	Result	Val Qual	LOQ
Microbial Community (cells/mL) QuantArray-Chlor	1,1 DCA Reductase (DCA)	NS	--	--	NS	--	--	ND	U	5.6	NS	--	--
	1,2 DCA Reductase (DCAR)	NS	--	--	NS	--	--	ND	U	5.6	NS	--	--
	BAV1 Vinyl Chloride Reductase (BVC)	NS	--	--	NS	--	--	ND	U	0.6	NS	--	--
	cer A Reductase	NS	--	--	NS	--	--	ND	U	5.6	NS	--	--
	Chloroform Reductase (CFR)	NS	--	--	NS	--	--	ND	U	5.6	NS	--	--
	Dehalobacter DCM (DCM)	NS	--	--	NS	--	--	193		5.6	NS	--	--
	Dehalobacter spp. (DHBT)	NS	--	--	NS	--	--	82300		5.6	NS	--	--
	Dehalobium chlorocoercia (DECO)	NS	--	--	NS	--	--	1590		5.6	NS	--	--
	Dehalococcoides (DHC)	NS	--	--	NS	--	--	0.5	J	0.6	NS	--	--
	Dehalogenimonas spp. (DHG)	NS	--	--	NS	--	--	ND	U	5.6	NS	--	--
	Desulfobacterium spp. (DSB)	NS	--	--	NS	--	--	33900		5.6	NS	--	--
	Desulfuromonas spp. (DSM)	NS	--	--	NS	--	--	0.4	J	5.6	NS	--	--
	Dichloromethane Dehalogenase (DCMA)	NS	--	--	NS	--	--	ND	U	5.6	NS	--	--
	Epoxyalkane Transferase (EtnE)	NS	--	--	NS	--	--	27.7		5.6	NS	--	--
	Ethene Monooxygenase (EtnC)	NS	--	--	NS	--	--	ND	U	5.6	NS	--	--
	Methanogens (MGN)	NS	--	--	NS	--	--	7040		5.6	NS	--	--
	PCE Reductase (PCE-1)	NS	--	--	NS	--	--	ND	U	5.6	NS	--	--
	Phenol Hydroxylase (PHE)	NS	--	--	NS	--	--	806		5.6	NS	--	--
	PMMO	NS	--	--	NS	--	--	NA	--	--	NS	--	--
	Soluble Methane Monooxygenase (SMMO)	NS	--	--	NS	--	--	ND	U	5.6	NS	--	--
	Sulfate Reducing Bacteria (APS)	NS	--	--	NS	--	--	131000		5.6	NS	--	--
	tceA Reductase (TCE)	NS	--	--	NS	--	--	0.2	J	0.6	NS	--	--
	Toluene Dioxygenase (TOD)	NS	--	--	NS	--	--	ND	U	5.6	NS	--	--
	Toluene Monooxygenase (RMO)	NS	--	--	NS	--	--	4420		5.6	NS	--	--
Toluene Monooxygenase 2 (RDEG)	NS	--	--	NS	--	--	5620		5.6	NS	--	--	
Total Eubacteria (EBAC)	NS	--	--	NS	--	--	1440000		5.6	NS	--	--	
trans-1,2-DCE Reductase (TDR)	NS	--	--	NS	--	--	ND	U	5.6	NS	--	--	
Trichlorobenzene Dioxygenase (TCBO)	NS	--	--	NS	--	--	ND	U	5.6	NS	--	--	
Vinyl Chloride Reductase (VCR)	NS	--	--	NS	--	--	0.9		0.6	NS	--	--	
EDB (µg/L) EPA Method 8011	1,2-DIBROMOETHANE	0.81		0.003	0.38	J+	0.0015	0.24		0.003	0.27		0.003
VFAs (mg/L) EPA Method 300m	ACETIC ACID	31.3		10	4		1	ND	U	1	ND	U	1
	BUTYRIC ACID	ND	U	1	ND	U	1	ND	U	1	ND	U	1
	FORMIC ACID	ND	U	1	ND	U	1	0.5	J	1	0.5	J	1
	LACTIC ACID	0.6	J	1	0.7	J	1	1.2		1	1		1
	PROPIONIC ACID	14.2		10	ND	U	1	ND	U	1	ND	U	1
	PYRUVIC ACID	ND	U	1	ND	U	1	ND	U	1	ND	U	1
Fluorometric (µg/L) Spectrofluorophotometry	VALERIC ACID	ND	U	1	ND	U	1	ND	U	1	ND	U	1
	FLUORESCEIN	NS	--	--	NS	--	--	NS	--	--	NS	--	--
Reduced Gases (µg/L) RSKSOP-175	ACETYLENE	ND	U	10	ND	U	10	ND	U	10	ND	U	10
	ETHANE	1.4	J	4	0.8	J	4	1.1	J	4	1	J	4
	ETHYLENE	3.5	J	5	1.3	J	5	1.1	J	5	1.1	J	5
	METHANE	2745.2		2	2903.9		2	2646		2	2704.5		2
	PROPANE	1.3	J	6	ND	U	6	1.1	J	6	1	J	6
General Chemistry (mg/L) SM2320b, EPA Method 300, EPA Method 353.2, SM4500 Pec	ALKALINITY	410		5	370		5	350		5	350		5
	BROMIDE	0.93		0.5	1.4		0.5	1		0.5	1		0.5
	CHLORIDE	52		0.5	49		0.5	47		0.5	47		0.5
	IODIDE	13		0.75	11		0.75	6.7		0.75	6.9		0.75
	NITRATE	NA	--	--	NA	--	--	NA	--	--	NA	--	--
	NITRITE	NA	--	--	NA	--	--	NA	--	--	NA	--	--
	NITROGEN, NITRATE-NITRITE	ND	U	0.1	ND	U	0.05	ND	U	0.5	ND	U	0.5
	O-PHOSPHATE (AS P)	NA	--	--	NA	--	--	NA	--	--	NA	--	--
	ORTHOPHOSPHATE	ND	U	0.15	ND	UJ	0.15	ND	UJ	0.15	ND	UJ	0.15
	PHOSPHORUS	NA	--	--	NA	--	--	NA	--	--	NA	--	--
	SULFATE	ND	U	1	ND	U	1	ND	U	1	ND	U	1

Table 14
Analytical Data Table for KAFB-106MW2-I

Phase Designation		Phase 3 Passive											
Sample ID		106MW2I-P3P-091118			106MW2I-P3P-100218			106MW2I-P3P-111518			106MW2I-P3P-111518-FD		
Sample Date		9/11/2018			10/2/2018			11/15/2018			11/15/2018		
Sample Purpose		REG			REG			REG			FD		
Chemical Class and Analytical Method ^a	Parameter	Result	Val Qual	LOQ	Result	Val Qual	LOQ	Result	Val Qual	LOQ	Result	Val Qual	LOQ
Metals (mg/L) EPA Method 6010	LEAD	NS	--	--	NS	--	--	NS	--	--	NS	--	--
Dissolved Metals (mg/L) EPA Method 6010	IRON	15		0.05	13		0.05	22		0.05	21		0.05
	MANGANESE	5.2		0.003	4.8		0.003	3.9		0.003	3.8		0.003
δ2H (‰) Mass Spectrometry, USGS Reston, VA	DELTA2H	NS	--	--	NS	--	--	NS	--	--	NS	--	--
VOCs (µg/L) EPA Method 8260	1,1,2-TRICHLOROETHANE	ND	U	50	ND	U	50	ND	U	50	ND	U	50
	1,2,4-TRICHLOROBENZENE	NA	--	--	NA	--	--	NA	--	--	NA	--	--
	1,2,4-TRIMETHYLBENZENE	240		100	170		100	55	J	100	57	J	100
	1,2-DIBROMOETHANE	ND	U	100	ND	U	100	ND	U	100	ND	U	100
	1,2-DICHLOROETHANE	ND	U	100	ND	U	100	ND	U	100	ND	U	100
	1,3,5-TRIMETHYLBENZENE	85	J	50	72	J	50	33	J	50	ND	U	50
	2-BUTANONE	ND	U	1000	ND	U	1000	ND	U	1000	ND	U	1000
	2-CHLOROTOLUENE	ND	U	50	ND	U	50	ND	U	50	ND	U	50
	2-HEXANONE	ND	U	500	ND	U	500	ND	U	500	ND	U	500
	4-METHYL-2-PENTANONE	ND	U	500	ND	U	500	ND	U	500	ND	U	500
	ACETONE	ND	U	1000	ND	U	1000	ND	U	1000	ND	U	1000
	BENZENE	3100		100	2300		100	630		100	610		100
	CARBON DISULFIDE	ND	U	200	ND	U	200	ND	U	200	ND	U	200
	CHLOROMETHANE	ND	U	100	ND	U	100	ND	U	100	ND	U	100
	CIS-1,2-DICHLOROETHENE	NA	--	--	NA	--	--	NA	--	--	NA	--	--
	DICHLORODIFLUOROMETHANE	ND	U	100	ND	U	100	ND	U	100	ND	U	100
	ETHYLBENZENE	730		100	410		100	170		100	170		100
	ISOPROPYLBENZENE	140		100	150		100	94	J	100	92	J	100
	M,P-XYLENES	NA	--	--	NA	--	--	NA	--	--	NA	--	--
	METHYL TERT-BUTYL ETHER	ND	U	50	ND	U	50	ND	U	50	ND	U	50
	METHYLENE CHLORIDE	ND	U	500	ND	U	500	ND	U	500	ND	U	500
	NAPHTHALENE	ND	U	500	ND	U	500	ND	U	500	ND	U	500
	N-BUTYLBENZENE	ND	U	100	ND	U	100	ND	U	100	ND	U	100
	N-PROPYLBENZENE	58	J	100	43	J	100	ND	U	100	ND	U	100
	O-XYLENE	NA	--	--	NA	--	--	NA	--	--	NA	--	--
	P-ISOPROPYLTOLUENE	100		100	180		100	ND	U	100	ND	U	100
	SEC-BUTYLBENZENE	ND	U	100	ND	U	100	ND	U	100	ND	U	100
	TERT-BUTYLBENZENE	ND	U	100	ND	U	100	ND	U	100	ND	U	100
	TETRACHLOROETHENE	NA	--	--	NA	--	--	NA	--	--	NA	--	--
	TOLUENE	3400		100	300		100	410		100	390		100
	TRANS-1,2-DICHLOROETHENE	NA	--	--	NA	--	--	NA	--	--	NA	--	--
	TRICHLOROETHENE	ND	U	100	ND	U	100	280		100	98	J	100
	TRICHLOROFUOROMETHANE	ND	U	100	ND	U	100	ND	U	100	ND	U	100
	VINYL CHLORIDE	NA	--	--	NA	--	--	NA	--	--	NA	--	--
	XYLENES	2100		50	1200		50	430		50	400		50

Refer to notes at the end of the table.

Table 14
Analytical Data Table for KAFB-106MW2-I

Phase Designation		Phase 4 Passive											
Sample ID		106MW2I-P4P-011719			106MW2I-LTM-031120			106MW2I-LTM-052020			106MW2I-LTM-080520		
Sample Date		1/17/2019			3/11/2020			5/20/2020			8/5/2020		
Sample Purpose		REG			REG			REG			REG		
Chemical Class and Analytical Method ^a	Parameter	Result	Val Qual	LOQ	Result	Val Qual	LOQ	Result	Val Qual	LOQ	Result	Val Qual	LOQ
Microbial Community (cells/mL) QuantArray-Chlor	1,1 DCA Reductase (DCA)	ND	U	4.9	ND	U	5.1	ND	U	4.9	ND	U	4.7
	1,2 DCA Reductase (DCAR)	ND	U	4.9	ND	U	5.1	ND	U	4.9	ND	U	4.7
	BAV1 Vinyl Chloride Reductase (BVC)	ND	U	0.5	ND	U	0.5	ND	U	0.5	ND	U	0.5
	cer A Reductase	ND	U	4.9	ND	U	5.1	ND	U	4.9	ND	U	4.7
	Chloroform Reductase (CFR)	ND	U	4.9	ND	U	5.1	ND	U	4.9	ND	U	4.7
	Dehalobacter DCM (DCM)	95.5		4.9	ND	U	5.1	ND	U	4.9	ND	U	4.7
	Dehalobacter spp. (DHBT)	70400		4.9	30700		5.1	22500		4.9	25100		4.7
	Dehalobium chloroocercia (DECO)	3950		4.9	5000		5.1	8000		4.9	8650		4.7
	Dehalococcoides (DHC)	0.9		0.5	2.2		0.5	0.6		0.5	0.9		0.5
	Dehalogenimonas spp. (DHG)	ND	U	4.9	ND	U	5.1	ND	U	4.9	ND	U	4.7
	Desulfotobacterium spp. (DSB)	13300		4.9	6500		5.1	7810		4.9	5590		4.7
	Desulfuromonas spp. (DSM)	65.2		4.9	5.2		5.1	18.6		4.9	ND	U	4.7
	Dichloromethane Dehalogenase (DCMA)	ND	U	4.9	ND	U	5.1	ND	U	4.9	ND	U	4.7
	Epoxyalkane Transferase (EtnE)	90.2		4.9	ND	U	5.1	2450		4.9	ND	U	4.7
	Ethene Monooxygenase (EtnC)	ND	U	4.9	ND	U	5.1	ND	U	4.9	ND	U	4.7
	Methanogens (MGN)	7070		4.9	1200		5.1	215		4.9	153		4.7
	PCE Reductase (PCE-1)	ND	U	4.9	ND	U	5.1	ND	U	4.9	ND	U	4.7
	Phenol Hydroxylase (PHE)	771		4.9	659		5.1	32500		4.9	181		4.7
	PMMO	NA	--	--	NA	--	--	NA	--	--	NA	--	--
	Soluble Methane Monooxygenase (SMMO)	261		4.9	3280		5.1	844		4.9	1520		4.7
	Sulfate Reducing Bacteria (APS)	304000		4.9	574000		5.1	460000		4.9	593000		4.7
	tceA Reductase (TCE)	ND	U	0.5	ND	U	0.5	ND	U	0.5	ND	U	0.5
	Toluene Dioxygenase (TOD)	ND	U	4.9	ND	U	5.1	ND	U	4.9	ND	U	4.7
	Toluene Monooxygenase (RMO)	14800		4.9	465		5.1	732		4.9	543		4.7
Toluene Monooxygenase 2 (RDEG)	42200		4.9	1460		5.1	17400		4.9	4620		4.7	
Total Eubacteria (EBAC)	6240000		4.9	2890000		5.1	4410000		4.9	6190000		4.7	
trans-1,2-DCE Reductase (TDR)	ND	U	4.9	ND	U	5.1	ND	U	4.9	ND	U	4.7	
Trichlorobenzene Dioxygenase (TCBO)	ND	U	4.9	ND	U	5.1	ND	U	4.9	ND	U	4.7	
Vinyl Chloride Reductase (VCR)	ND	U	0.5	0.4	J	0.5	ND	U	0.5	ND	U	0.5	
EDB (µg/L) EPA Method 8011	1,2-DIBROMOETHANE	0.41		0.003	0.17		0.011	0.038		0.01	ND	U	0.01
VFAs (mg/L) EPA Method 300m	ACETIC ACID	0.5	J	1	ND	U	1	ND	U	10	ND	U	10
	BUTYRIC ACID	ND	U	1	ND	U	1	ND	U	10	ND	U	10
	FORMIC ACID	ND	U	1	0.9	J	10	0.3	J	10	5.2	J	10
	LACTIC ACID	1.5		1	1.8	J	10	1.4	J	10	1.9	J	10
	PROPIONIC ACID	ND	U	1	ND	U	1	ND	U	10	ND	U	10
	PYRUVIC ACID	ND	U	1	ND	U	1	ND	U	10	ND	U	10
	VALERIC ACID	ND	U	1	ND	U	1	ND	U	10	ND	U	10
Fluorometric (µg/L) Spectrofluorophotometry	FLUORESCEIN	NS	--	--	NS	--	--	NS	--	--	NS	--	--
Reduced Gases (µg/L) RSKSOP-175	ACETYLENE	ND	U	10	ND	U	10	ND	U	10	ND	U	10
	ETHANE	ND	U	4	ND	U	4	ND	U	4	1	J	4
	ETHYLENE	ND	U	5	ND	U	5	ND	U	5	ND	U	5
	METHANE	1989.6		2	45		2	203.8		2	137.5		2
	PROPANE	ND	U	6	ND	U	6	ND	U	6	ND	U	6
General Chemistry (mg/L) SM2320b, EPA Method 300, EPA Method 353.2, SM4500 Pec	ALKALINITY	230		5	185		5	224		5	266		5
	BROMIDE	ND	U	0.5	0.254		0.1	0.636		0.1	2.77		0.1
	CHLORIDE	27		0.5	24.7		0.5	61.1		0.5	149		5
	IODIDE	2.1	J+	0.75	ND	U	0.2	ND	U	0.2	ND	U	2
	NITRATE	NA	--	--	0.144		0.1	0.0964	J	0.1	ND	U	0.1
	NITRITE	NA	--	--	NA	--	--	NA	--	--	NA	--	--
	NITROGEN, NITRATE-NITRITE	ND	UJ	0.05	ND	U	0.1	ND	U	0.1	ND	U	0.1
	O-PHOSPHATE (AS P)	NA	--	--	NA	--	--	NA	--	--	NA	--	--
	ORTHOPHOSPHATE	ND	UJ	0.15	NA	--	--	NA	--	--	NA	--	--
	PHOSPHORUS	NA	--	--	ND	U	0.025	ND	U	0.025	ND	U	0.025
	SULFATE	12		1	34.7		0.5	28.7		0.5	33.7		0.5

Table 14
Analytical Data Table for KAFB-106MW2-I

Phase Designation		Phase 4 Passive											
Sample ID		106MW2I-P4P-011719			106MW2I-LTM-031120			106MW2I-LTM-052020			106MW2I-LTM-080520		
Sample Date		1/17/2019			3/11/2020			5/20/2020			8/5/2020		
Sample Purpose		REG			REG			REG			REG		
Chemical Class and Analytical Method ^a	Parameter	Result	Val Qual	LOQ	Result	Val Qual	LOQ	Result	Val Qual	LOQ	Result	Val Qual	LOQ
Metals (mg/L) EPA Method 6010	LEAD	NS	--	--	ND	U	0.001	ND	U	0.001	ND	U	0.001
Dissolved Metals (mg/L) EPA Method 6010	IRON	6.4		0.05	0.885		0.05	2.37		0.05	6.36		0.05
	MANGANESE	2.1		0.003	0.641		0.0025	1.93		0.05	4.12		0.125
δ2H (‰) Mass Spectrometry, USGS Reston, VA	DELTA2H	NS	--	--	NS	--	--	NS	--	--	NS	--	--
VOCs (µg/L) EPA Method 8260	1,1,2-TRICHLOROETHANE	ND	U	1	ND	U	0.5	ND	U	1	ND	U	1
	1,2,4-TRICHLOROBENZENE	NA	--	--	ND	U	0.5	ND	U	1	ND	U	1
	1,2,4-TRIMETHYLBENZENE	14		2	NA	--	--	NA	--	--	NA	--	--
	1,2-DIBROMOETHANE	ND	U	2	ND	U	0.5	ND	U	0.5	ND	U	0.5
	1,2-DICHLOROETHANE	NA	--	--	ND	U	0.5	ND	U	0.5	ND	U	0.5
	1,3,5-TRIMETHYLBENZENE	5.1		1	ND	U	0.5	ND	U	1	ND	U	1
	2-BUTANONE	ND	U	20	ND	U	1	ND	U	1	ND	U	1
	2-CHLOROTOLUENE	ND	U	1	ND	U	0.5	ND	U	1	ND	U	1
	2-HEXANONE	ND	U	10	ND	U	1	ND	U	2	ND	U	2
	4-METHYL-2-PENTANONE	ND	U	10	ND	U	1	ND	U	2	ND	U	2
	ACETONE	ND	U	20	ND	U	1	ND	U	1	ND	U	1
	BENZENE	130		2	1.2		0.5	ND	U	0.5	1.2		0.5
	CARBON DISULFIDE	ND	U	4	ND	U	1	ND	U	1	ND	U	1
	CHLOROMETHANE	ND	U	2	ND	U	0.5	ND	U	0.5	ND	U	0.5
	CIS-1,2-DICHLOROETHENE	NA	--	--	ND	U	0.5	ND	U	0.5	ND	U	0.5
	DICHLORODIFLUOROMETHANE	NA	--	--	ND	U	0.5	ND	U	1	ND	U	1
	ETHYLBENZENE	NA	--	--	ND	U	0.5	ND	U	1	ND	UJ	1
	ISOPROPYLBENZENE	48		2	12		0.5	10		1	10		1
	M,P-XYLENES	NA	--	--	ND	U	1	ND	U	1	ND	U	1
	METHYL TERT-BUTYL ETHER	ND	U	1	ND	U	0.5	ND	U	0.5	ND	U	0.5
	METHYLENE CHLORIDE	ND	U	10	ND	U	1	ND	U	1	ND	U	1
	NAPHTHALENE	ND	U	10	ND	U	0.5	ND	U	1	ND	U	1
	N-BUTYLBENZENE	ND	U	2	ND	U	0.5	ND	U	1	ND	U	1
	N-PROPYLBENZENE	2.7		2	ND	U	0.5	ND	U	1	ND	U	1
	O-XYLENE	NA	--	--	ND	U	0.5	ND	U	1	ND	U	1
	P-ISOPROPYLTOLUENE	38		2	12		0.5	11		1	ND	U	1
	SEC-BUTYLBENZENE	ND	U	2	ND	U	0.5	ND	U	1	1.7		1
	TERT-BUTYLBENZENE	ND	U	2	ND	U	0.5	ND	U	1	ND	U	1
	TETRACHLOROETHENE	NA	--	--	ND	U	0.5	ND	U	1	ND	U	1
	TOLUENE	7.4		2	ND	U	0.5	ND	U	0.5	ND	U	0.5
	TRANS-1,2-DICHLOROETHENE	NA	--	--	ND	U	0.5	ND	U	0.5	ND	U	0.5
	TRICHLOROETHENE	ND	U	2	ND	U	0.5	ND	U	0.5	ND	U	0.5
	TRICHLOROFUOROMETHANE	ND	U	2	ND	U	0.5	ND	U	1	ND	U	1
	VINYL CHLORIDE	NA	--	--	ND	U	0.5	ND	U	0.5	ND	U	0.5
	XYLENES	82		1	ND	U	0.5	ND	U	1	ND	U	1

Refer to notes at the end of the table.

Table 14
Analytical Data Table for KAFB-106MW2-I

Phase Designation		Phase 4 Passive		
Sample ID		106MW2I-LTM-101420		
Sample Date		10/14/2020		
Sample Purpose		REG		
Chemical Class and Analytical Method ^a	Parameter	Result	Val Qual	LOQ
Microbial Community (cells/mL) QuantArray-Chlor	1,1 DCA Reductase (DCA)	4.8		4.8
	1,2 DCA Reductase (DCAR)	4.8		4.8
	BAV1 Vinyl Chloride Reductase (BVC)	0.5		0.5
	cer A Reductase	4.8		4.8
	Chloroform Reductase (CFR)	4.8		4.8
	Dehalobacter DCM (DCM)	4.8		4.8
	Dehalobacter spp. (DHBt)	8900		4.8
	Dehalobium chlorocoercia (DECO)	5780		4.8
	Dehalococcoides (DHC)	3.3		0.5
	Dehalogenimonas spp. (DHG)	4.8		4.8
	Desulfitobacterium spp. (DSB)	2380		4.8
	Desulfuromonas spp. (DSM)	4.8		4.8
	Dichloromethane Dehalogenase (DCMA)	4.8		4.8
	Epoxyalkane Transferase (EtnE)	4.8		4.8
	Ethene Monooxygenase (EtnC)	4.8		4.8
	Methanogens (MGN)	131		4.8
	PCE Reductase (PCE-1)	4.8		4.8
	Phenol Hydroxylase (PHE)	825		4.8
	PMMO	NA	--	--
	Soluble Methane Monooxygenase (SMMO)	199		4.8
	Sulfate Reducing Bacteria (APS)	450000		4.8
	tceA Reductase (TCE)	0.5		0.5
	Toluene Dioxygenase (TOD)	4.8		4.8
	Toluene Monooxygenase (RMO)	4.8		4.8
	Toluene Monooxygenase 2 (RDEG)	1780		4.8
	Total Eubacteria (EBAC)	5410000		4.8
trans-1,2-DCE Reductase (TDR)	4.8		4.8	
Trichlorobenzene Dioxygenase (TCBO)	4.8		4.8	
Vinyl Chloride Reductase (VCR)	0.5		0.5	
EDB (µg/L) EPA Method 8011	1,2-DIBROMOETHANE	ND	U	0.01
VFAs (mg/L) EPA Method 300m	ACETIC ACID	ND	U	10
	BUTYRIC ACID	ND	U	10
	FORMIC ACID	1.3	J	10
	LACTIC ACID	0.5	J	10
	PROPIONIC ACID	ND	U	10
	PYRUVIC ACID	ND	U	10
Fluorometric (µg/L) Spectrofluorophotometry	VALERIC ACID	ND	U	10
	FLUORESCEIN	NS	--	--
Reduced Gases (µg/L) RSKSOP-175	ACETYLENE	ND	U	10
	ETHANE	0.6		4
	ETHYLENE	5		5
	METHANE	21.9		2
	PROPANE	6		6
General Chemistry (mg/L) SM2320b, EPA Method 300, EPA Method 353.2, SM4500 Pec	ALKALINITY	327		5
	BROMIDE	2.33		0.1
	CHLORIDE	153		5
	IODIDE	0.35		
	NITRATE	ND	UJ	0.1
	NITRITE	NA	--	--
	NITROGEN, NITRATE-NITRITE	ND	UJ	0.1
	O-PHOSPHATE (AS P)	NA	--	--
	ORTHOPHOSPHATE	NA	--	--
	PHOSPHORUS	ND	U	0.025
	SULFATE	16.7		0.5

Table 14
Analytical Data Table for KAFB-106MW2-I

Phase Designation		Phase 4 Passive		
Sample ID		106MW2I-LTM-101420		
Sample Date		10/14/2020		
Sample Purpose		REG		
Chemical Class and Analytical Method ^a	Parameter	Result	Val Qual	LOQ
Metals (mg/L) EPA Method 6010	LEAD	ND	U	0.001
Dissolved Metals (mg/L) EPA Method 6010	IRON	5.49		0.05
	MANGANESE	4.19		0.125
δ2H (‰) Mass Spectrometry, USGS Reston, VA	DELTA2H	NS	--	--
VOCs (µg/L) EPA Method 8260	1,1,2-TRICHLOROETHANE	ND	U	0.5
	1,2,4-TRICHLOROBENZENE	ND	U	1
	1,2,4-TRIMETHYLBENZENE	NA	--	--
	1,2-DIBROMOETHANE	ND	U	0.5
	1,2-DICHLOROETHANE	ND	U	0.5
	1,3,5-TRIMETHYLBENZENE	ND	U	0.5
	2-BUTANONE	ND	U	1
	2-CHLOROTOLUENE	ND	U	1
	2-HEXANONE	ND	U	2
	4-METHYL-2-PENTANONE	ND	U	2
	ACETONE	2.8		1
	BENZENE	0.67	J	0.5
	CARBON DISULFIDE	ND	U	2
	CHLOROMETHANE	ND	U	0.5
	CIS-1,2-DICHLOROETHENE	ND	U	0.5
	DICHLORODIFLUOROMETHANE	ND	U	1
	ETHYLBENZENE	7.6	J+	1
	ISOPROPYLBENZENE	21		0.5
	M,P-XYLENES	ND	U	1
	METHYL TERT-BUTYL ETHER	ND	U	0.5
	METHYLENE CHLORIDE	ND	U	1
	NAPHTHALENE	ND	U	0.5
	N-BUTYLBENZENE	ND	U	1
	N-PROPYLBENZENE	ND	U	1
	O-XYLENE	ND	U	1
	P-ISOPROPYLTOLUENE	ND	U	1
	SEC-BUTYLBENZENE	5.1		0.5
	TERT-BUTYLBENZENE	1	J+	0.5
	TETRACHLOROETHENE	ND	U	0.5
	TOLUENE	ND	U	0.5
	TRANS-1,2-DICHLOROETHENE	ND	U	0.5
	TRICHLOROETHENE	ND	U	0.5
	TRICHLOROFUOROMETHANE	ND	U	0.5
	VINYL CHLORIDE	ND	U	0.5
	XYLENES	ND	U	0.5

Refer to notes at the end of the table.

Table 14
Analytical Data Table for KAFB-106MW2-I

Notes:

Sampling frequency for each analytical method is outlined in Table 4.

a. EPA analytical methods listed are for the most recent sampling event.

b. Samples were collected using replacement QED Bladder Pumps. This well was not sampled using the Geotech pumps.

-- = Not applicable.

δ2H - Delta Deuterium.

0/00 - Per mil.

cells/mL = Cells per milliliter.

EPA = Environmental Protection Agency.

FD = Field duplicate.

ID = Identification.

J = Estimated value, concentration is less than LOQ but greater than laboratory method detection limit (DL).

J+ = Estimated value, concentration is less than LOQ but greater than laboratory method detection limit (DL); biased high.

J- = Estimated value, concentration is less than LOQ but greater than laboratory method detection limit (DL); biased low.

KAFB = Kirtland Air Force Base.

LOQ = Limit of Quantitation

µg/L = Microgram per liter.

mg/L = Milligram per liter.

NA = Not analyzed.

ND = Not detected.

NS = Not sampled.

REG = Regular/parent sample.

U = Analyte was not detected. The reported numerical value is at or below the LOQ.

UJ = Analyte was not detected. The reported value is estimated.

VAL QUAL = Validation qualifier.

VFA - Volatile fatty acid.

VOC = Volatile organic compound.

Table 15
Analytical Data Table for KAFB-106MW2-S

Phase Designation		Original Baseline ^b			New Baseline - QED Pumps ^c			Phase 1 Recirculation					
Sample ID		106MW2S-BL-080717			106MW2S-BL-091917			106MW2S-P1R-100417			106MW2S-P1R-100617		
Sample Date		8/7/2017			9/19/2017			10/4/2017			10/6/2017		
Sample Purpose		REG			REG			REG			REG		
Chemical Class and Analytical Method ^a	Parameter	Result	Val Qual	LOQ	Result	Val Qual	LOQ	Result	Val Qual	LOQ	Result	Val Qual	LOQ
Microbial Community (cells/mL) QuantArray-Chlor	1,1 DCA Reductase (DCA)	ND	U	5.2	NS	--	--	NS	--	--	NS	--	--
	1,2 DCA Reductase (DCAR)	ND	U	5.2	NS	--	--	NS	--	--	NS	--	--
	BAV1 Vinyl Chloride Reductase (BVC)	ND	U	0.5	NS	--	--	NS	--	--	NS	--	--
	cer A Reductase	NA	--	--	NS	--	--	NS	--	--	NS	--	--
	Chloroform Reductase (CFR)	ND	U	5.2	NS	--	--	NS	--	--	NS	--	--
	Dehalobacter DCM (DCM)	ND	U	5.2	NS	--	--	NS	--	--	NS	--	--
	Dehalobacter spp. (DHBt)	129000		5.2	NS	--	--	NS	--	--	NS	--	--
	Dehalobium chlorocoercia (DECO)	6350		5.2	NS	--	--	NS	--	--	NS	--	--
	Dehalococcoides (DHC)	2.6		0.5	NS	--	--	NS	--	--	NS	--	--
	Dehalogenimonas spp. (DHG)	ND	U	5.2	NS	--	--	NS	--	--	NS	--	--
	Desulfitobacterium spp. (DSB)	129000		5.2	NS	--	--	NS	--	--	NS	--	--
	Desulfuromonas spp. (DSM)	ND	U	5.2	NS	--	--	NS	--	--	NS	--	--
	Dichloromethane Dehalogenase (DCMA)	ND	U	5.2	NS	--	--	NS	--	--	NS	--	--
	Epoxyalkane Transferase (EtnE)	ND	U	5.2	NS	--	--	NS	--	--	NS	--	--
	Ethene Monooxygenase (EtnC)	ND	U	5.2	NS	--	--	NS	--	--	NS	--	--
	Methanogens (MGN)	3080		5.2	NS	--	--	NS	--	--	NS	--	--
	PCE Reductase (PCE-1)	NA	--	--	NS	--	--	NS	--	--	NS	--	--
	Phenol Hydroxylase (PHE)	408000		5.2	NS	--	--	NS	--	--	NS	--	--
	PMMO	301		5.2	NS	--	--	NS	--	--	NS	--	--
	Soluble Methane Monooxygenase (SMMO)	1190		5.2	NS	--	--	NS	--	--	NS	--	--
	Sulfate Reducing Bacteria (APS)	73400		5.2	NS	--	--	NS	--	--	NS	--	--
	tceA Reductase (TCE)	1.3		0.5	NS	--	--	NS	--	--	NS	--	--
	Toluene Dioxygenase (TOD)	68.1		5.2	NS	--	--	NS	--	--	NS	--	--
	Toluene Monooxygenase (RMO)	521000		5.2	NS	--	--	NS	--	--	NS	--	--
	Toluene Monooxygenase 2 (RDEG)	124000		5.2	NS	--	--	NS	--	--	NS	--	--
	Total Eubacteria (EBAC)	12100000		5.2	NS	--	--	NS	--	--	NS	--	--
	trans-1,2-DCE Reductase (TDR)	NA	--	--	NS	--	--	NS	--	--	NS	--	--
Trichlorobenzene Dioxygenase (TCBO)	79.8		5.2	NS	--	--	NS	--	--	NS	--	--	
Vinyl Chloride Reductase (VCR)	ND	U	0.5	NS	--	--	NS	--	--	NS	--	--	
EDB (µg/L) EPA Method 8011	1,2-DIBROMOETHANE	42.5	J+	0.0189	84.9	J+	3.87	NS	--	--	NS	--	--
VFAs (mg/L) EPA Method 300m	ACETIC ACID	84.8		10	45		1	NS	--	--	NS	--	--
	BUTYRIC ACID	9.87		1	ND	U	1	NS	--	--	NS	--	--
	FORMIC ACID	ND	U	1	ND	U	1	NS	--	--	NS	--	--
	LACTIC ACID	ND	U	1	1.29		1	NS	--	--	NS	--	--
	PROPIONIC ACID	11.8		1	6.22		1	NS	--	--	NS	--	--
	PYRUVIC ACID	ND	U	1	ND	U	1	NS	--	--	NS	--	--
	VALERIC ACID	ND	U	1	ND	U	1	NS	--	--	NS	--	--
Fluorometric (µg/L) Spectrofluorophotometry	FLUORESCEIN	ND	U	0.01	ND	U	0.01	ND	U	0.01	207.7		0.01
Reduced Gases (µg/L) RSKSOP-175	ACETYLENE	ND	U	10	ND	U	10	NS	--	--	NS	--	--
	ETHANE	1.12	J	4	4.08		4	NS	--	--	NS	--	--
	ETHYLENE	8.67		5	19.2		5	NS	--	--	NS	--	--
	METHANE	23.2		2	19		2	NS	--	--	NS	--	--
	PROPANE	1.19	J	6	4.88	J	6	NS	--	--	NS	--	--
General Chemistry (mg/L) SM2320b, EPA Method 300, EPA Method 353.2, SM4500 Pe ^c	ALKALINITY	374	J-	1	326		1	NS	--	--	NS	--	--
	BROMIDE	0.306	J	0.25	0.283		0.125	NS	--	--	NS	--	--
	CHLORIDE	11.5		0.66	11.4		0.33	NS	--	--	NS	--	--
	IODIDE	ND	U	0.2	ND	U	0.75	NS	--	--	NS	--	--
	NITRATE	NA	--	--	NA	--	--	NS	--	--	NS	--	--
	NITRITE	NA	--	--	NA	--	--	NS	--	--	NS	--	--

Table 15
Analytical Data Table for KAFB-106MW2-S

Phase Designation		Original Baseline ^b			New Baseline - QED Pumps ^c			Phase 1 Recirculation					
Sample ID		106MW2S-BL-080717			106MW2S-BL-091917			106MW2S-P1R-100417			106MW2S-P1R-100617		
Sample Date		8/7/2017			9/19/2017			10/4/2017			10/6/2017		
Sample Purpose		REG			REG			REG			REG		
Chemical Class and Analytical Method ^a	Parameter	Result	Val Qual	LOQ	Result	Val Qual	LOQ	Result	Val Qual	LOQ	Result	Val Qual	LOQ
General Chemistry (mg/L) SM2320b, EPA Method 300, EPA Method 353.2, SM4500 Pec	NITROGEN, NITRATE-NITRITE	ND	U	0.375	ND	U	0.375	NS	--	--	NS	--	--
	O-PHOSPHATE (AS P)	0.0608		0.02	0.0392	J	0.02	NS	--	--	NS	--	--
	ORTHOPHOSPHATE	NA	--	--	NA	--	--	NS	--	--	NS	--	--
	PHOSPHORUS	NA	--	--	NA	--	--	NS	--	--	NS	--	--
	SULFATE	ND	U	2	0.807		1	NS	--	--	NS	--	--
Metals (mg/L) EPA Method 6010	LEAD	NS	--	--	NS	--	--	NS	--	--	NS	--	--
Dissolved Metals (mg/L) EPA Method 6010	IRON	12.8		0.06	11.7		0.06	NS	--	--	NS	--	--
	MANGANESE	5.52		0.006	5.19		0.006	NS	--	--	NS	--	--
δ2H (‰) Mass Spectrometry, USGS Reston, VA	DELTA2H	-96		-99	-95.38		-99	-94.21		-99	127.94		-99
CSIA EDB δ13C (‰) Kuder et al, 2012	EDB δ	-8.9 ±2‰	--	--	-8.7 ±2‰	--	--	NS	--	--	NS	--	--
VOCs (µg/L) EPA Method 8260	1,1,2-TRICHLOROETHANE	ND	U	10	ND	U	12.5	NS	--	--	NS	--	--
	1,2,4-TRICHLOROBENZENE	NA	--	--	NA	--	--	NS	--	--	NS	--	--
	1,2,4-TRIMETHYLBENZENE	105		10	110		12.5	NS	--	--	NS	--	--
	1,2-DIBROMOETHANE	54.7		10	106		12.5	NS	--	--	NS	--	--
	1,2-DICHLOROETHANE	ND	U	10	ND	U	12.5	NS	--	--	NS	--	--
	1,3,5-TRIMETHYLBENZENE	34.6		10	40.7		12.5	NS	--	--	NS	--	--
	2-BUTANONE	447		100	496		125	NS	--	--	NS	--	--
	2-CHLOROTOLUENE	ND	U	10	ND	U	12.5	NS	--	--	NS	--	--
	2-HEXANONE	754		50	906		62.5	NS	--	--	NS	--	--
	4-METHYL-2-PENTANONE	569		50	665		62.5	NS	--	--	NS	--	--
	ACETONE	2480		100	2340		125	NS	--	--	NS	--	--
	BENZENE	1390		10	586		12.5	NS	--	--	NS	--	--
	CARBON DISULFIDE	ND	U	10	ND	U	12.5	NS	--	--	NS	--	--
	CHLOROMETHANE	ND	U	10	ND	U	12.5	NS	--	--	NS	--	--
	CIS-1,2-DICHLOROETHENE	NA	--	--	NA	--	--	NS	--	--	NS	--	--
	DICHLORODIFLUOROMETHANE	ND	U	20	ND	U	25	NS	--	--	NS	--	--
	ETHYLBENZENE	245		10	209		12.5	NS	--	--	NS	--	--
	ISOPROPYLBENZENE	141		10	116		12.5	NS	--	--	NS	--	--
	M,P-XYLENES	NA	--	--	NA	--	--	NS	--	--	NS	--	--
	METHYL TERT-BUTYL ETHER	ND	U	10	ND	U	12.5	NS	--	--	NS	--	--
	METHYLENE CHLORIDE	ND	U	20	ND	U	25	NS	--	--	NS	--	--
	NAPHTHALENE	81.6	J+	10	113		12.5	NS	--	--	NS	--	--
	N-BUTYLBENZENE	6.22	J	10	6.76	J	12.5	NS	--	--	NS	--	--
	N-PROPYLBENZENE	16.5	J	10	14.1	J	12.5	NS	--	--	NS	--	--
	O-XYLENE	NA	--	--	NA	--	--	NS	--	--	NS	--	--
	P-ISOPROPYLTOLUENE	310		10	354		12.5	NS	--	--	NS	--	--
	SEC-BUTYLBENZENE	6.2	J	10	ND	U	12.5	NS	--	--	NS	--	--
	TERT-BUTYLBENZENE	ND	U	10	ND	U	12.5	NS	--	--	NS	--	--
	TETRACHLOROETHENE	NA	--	--	NA	--	--	NS	--	--	NS	--	--
	TOLUENE	2260		10	1540		12.5	NS	--	--	NS	--	--
TRANS-1,2-DICHLOROETHENE	NA	--	--	NA	--	--	NS	--	--	NS	--	--	
TRICHLOROETHENE	ND	U	10	ND	U	12.5	NS	--	--	NS	--	--	
TRICHLOROFUOROMETHANE	ND	U	20	ND	U	25	NS	--	--	NS	--	--	
VINYL CHLORIDE	NA	--	--	NA	--	--	NS	--	--	NS	--	--	
XYLENES	1350		30	1690		37.5	NS	--	--	NS	--	--	

Refer to notes at the end of the table.

Table 15
Analytical Data Table for KAFB-106MW2-S

Phase Designation		Phase 1 Recirculation											
Sample ID		106MW2S-P1R-100917			106MW2S-P1R-101217			106MW2S-P1R-101217-FD			106MW2S-P1R-101617		
Sample Date		10/9/2017			10/12/2017			10/12/2017			10/16/2017		
Sample Purpose		REG			REG			FD			REG		
Chemical Class and Analytical Method ^a	Parameter	Result	Val Qual	LOQ	Result	Val Qual	LOQ	Result	Val Qual	LOQ	Result	Val Qual	LOQ
Microbial Community (cells/mL) QuantArray-Chlor	1,1 DCA Reductase (DCA)	NS	--	--	NS	--	--	NS	--	--	NS	--	--
	1,2 DCA Reductase (DCAR)	NS	--	--	NS	--	--	NS	--	--	NS	--	--
	BAV1 Vinyl Chloride Reductase (BVC)	NS	--	--	NS	--	--	NS	--	--	NS	--	--
	cer A Reductase	NS	--	--	NS	--	--	NS	--	--	NS	--	--
	Chloroform Reductase (CFR)	NS	--	--	NS	--	--	NS	--	--	NS	--	--
	Dehalobacter DCM (DCM)	NS	--	--	NS	--	--	NS	--	--	NS	--	--
	Dehalobacter spp. (DHBt)	NS	--	--	NS	--	--	NS	--	--	NS	--	--
	Dehalobium chloroeracia (DECO)	NS	--	--	NS	--	--	NS	--	--	NS	--	--
	Dehalococcoides (DHC)	NS	--	--	NS	--	--	NS	--	--	NS	--	--
	Dehalogenimonas spp. (DHG)	NS	--	--	NS	--	--	NS	--	--	NS	--	--
	Desulfitobacterium spp. (DSB)	NS	--	--	NS	--	--	NS	--	--	NS	--	--
	Desulfuromonas spp. (DSM)	NS	--	--	NS	--	--	NS	--	--	NS	--	--
	Dichloromethane Dehalogenase (DCMA)	NS	--	--	NS	--	--	NS	--	--	NS	--	--
	Epoxyalkane Transferase (EtnE)	NS	--	--	NS	--	--	NS	--	--	NS	--	--
	Ethene Monooxygenase (EtnC)	NS	--	--	NS	--	--	NS	--	--	NS	--	--
	Methanogens (MGN)	NS	--	--	NS	--	--	NS	--	--	NS	--	--
	PCE Reductase (PCE-1)	NS	--	--	NS	--	--	NS	--	--	NS	--	--
	Phenol Hydroxylase (PHE)	NS	--	--	NS	--	--	NS	--	--	NS	--	--
	PMMO	NS	--	--	NS	--	--	NS	--	--	NS	--	--
	Soluble Methane Monooxygenase (SMMO)	NS	--	--	NS	--	--	NS	--	--	NS	--	--
	Sulfate Reducing Bacteria (APS)	NS	--	--	NS	--	--	NS	--	--	NS	--	--
	tceA Reductase (TCE)	NS	--	--	NS	--	--	NS	--	--	NS	--	--
	Toluene Dioxygenase (TOD)	NS	--	--	NS	--	--	NS	--	--	NS	--	--
	Toluene Monooxygenase (RMO)	NS	--	--	NS	--	--	NS	--	--	NS	--	--
	Toluene Monooxygenase 2 (RDEG)	NS	--	--	NS	--	--	NS	--	--	NS	--	--
	Total Eubacteria (EBAC)	NS	--	--	NS	--	--	NS	--	--	NS	--	--
	trans-1,2-DCE Reductase (TDR)	NS	--	--	NS	--	--	NS	--	--	NS	--	--
Trichlorobenzene Dioxygenase (TCBO)	NS	--	--	NS	--	--	NS	--	--	NS	--	--	
Vinyl Chloride Reductase (VCR)	NS	--	--	NS	--	--	NS	--	--	NS	--	--	
EDB (µg/L) EPA Method 8011	1,2-DIBROMOETHANE	NS	--	--	NS	--	--	NS	--	--	NS	--	--
VFAs (mg/L) EPA Method 300m	ACETIC ACID	NS	--	--	NS	--	--	NS	--	--	NS	--	--
	BUTYRIC ACID	NS	--	--	NS	--	--	NS	--	--	NS	--	--
	FORMIC ACID	NS	--	--	NS	--	--	NS	--	--	NS	--	--
	LACTIC ACID	NS	--	--	NS	--	--	NS	--	--	NS	--	--
	PROPIONIC ACID	NS	--	--	NS	--	--	NS	--	--	NS	--	--
	PYRUVIC ACID	NS	--	--	NS	--	--	NS	--	--	NS	--	--
	VALERIC ACID	NS	--	--	NS	--	--	NS	--	--	NS	--	--
Fluorometric (µg/L) Spectrofluorophotometry	FLUORESCEIN	16.789		0.01	1.535		0.01	1.527		0.01	2.485		0.01
Reduced Gases (µg/L) RSKSOP-175	ACETYLENE	NS	--	--	NS	--	--	NS	--	--	NS	--	--
	ETHANE	NS	--	--	NS	--	--	NS	--	--	NS	--	--
	ETHYLENE	NS	--	--	NS	--	--	NS	--	--	NS	--	--
	METHANE	NS	--	--	NS	--	--	NS	--	--	NS	--	--
	PROPANE	NS	--	--	NS	--	--	NS	--	--	NS	--	--
General Chemistry (mg/L) SM2320b, EPA Method 300, EPA Method 353.2, SM4500 Pe ^c	ALKALINITY	NS	--	--	NS	--	--	NS	--	--	NS	--	--
	BROMIDE	NS	--	--	NS	--	--	NS	--	--	NS	--	--
	CHLORIDE	NS	--	--	NS	--	--	NS	--	--	NS	--	--
	IODIDE	NS	--	--	NS	--	--	NS	--	--	NS	--	--
	NITRATE	NS	--	--	NS	--	--	NS	--	--	NS	--	--
	NITRITE	NS	--	--	NS	--	--	NS	--	--	NS	--	--

Table 15
Analytical Data Table for KAFB-106MW2-S

Phase Designation		Phase 1 Recirculation											
Sample ID		106MW2S-P1R-100917			106MW2S-P1R-101217			106MW2S-P1R-101217-FD			106MW2S-P1R-101617		
Sample Date		10/9/2017			10/12/2017			10/12/2017			10/16/2017		
Sample Purpose		REG			REG			FD			REG		
Chemical Class and Analytical Method ^a	Parameter	Result	Val Qual	LOQ	Result	Val Qual	LOQ	Result	Val Qual	LOQ	Result	Val Qual	LOQ
General Chemistry (mg/L) SM2320b, EPA Method 300, EPA Method 353.2, SM4500 Pec	NITROGEN, NITRATE-NITRITE	NS	--	--	NS	--	--	NS	--	--	NS	--	--
	O-PHOSPHATE (AS P)	NS	--	--	NS	--	--	NS	--	--	NS	--	--
	ORTHOPHOSPHATE	NS	--	--	NS	--	--	NS	--	--	NS	--	--
	PHOSPHORUS	NS	--	--	NS	--	--	NS	--	--	NS	--	--
	SULFATE	NS	--	--	NS	--	--	NS	--	--	NS	--	--
Metals (mg/L) EPA Method 6010	LEAD	NS	--	--	NS	--	--	NS	--	--	NS	--	--
Dissolved Metals (mg/L) EPA Method 6010	IRON	NS	--	--	NS	--	--	NS	--	--	NS	--	--
	MANGANESE	NS	--	--	NS	--	--	NS	--	--	NS	--	--
δ2H (‰) Mass Spectrometry, USGS Reston, VA	DELTA2H	-72.81		-99	-93.69		-99	-93.42		-99	-92.61		-99
CSIA EDB δ13C (‰) Kuder et al, 2012	EDB δ	NS	--	--	NS	--	--	NS	--	--	NS	--	--
VOCs (µg/L) EPA Method 8260	1,1,2-TRICHLOROETHANE	NS	--	--	NS	--	--	NS	--	--	NS	--	--
	1,2,4-TRICHLOROBENZENE	NS	--	--	NS	--	--	NS	--	--	NS	--	--
	1,2,4-TRIMETHYLBENZENE	NS	--	--	NS	--	--	NS	--	--	NS	--	--
	1,2-DIBROMOETHANE	NS	--	--	NS	--	--	NS	--	--	NS	--	--
	1,2-DICHLOROETHANE	NS	--	--	NS	--	--	NS	--	--	NS	--	--
	1,3,5-TRIMETHYLBENZENE	NS	--	--	NS	--	--	NS	--	--	NS	--	--
	2-BUTANONE	NS	--	--	NS	--	--	NS	--	--	NS	--	--
	2-CHLOROTOLUENE	NS	--	--	NS	--	--	NS	--	--	NS	--	--
	2-HEXANONE	NS	--	--	NS	--	--	NS	--	--	NS	--	--
	4-METHYL-2-PENTANONE	NS	--	--	NS	--	--	NS	--	--	NS	--	--
	ACETONE	NS	--	--	NS	--	--	NS	--	--	NS	--	--
	BENZENE	NS	--	--	NS	--	--	NS	--	--	NS	--	--
	CARBON DISULFIDE	NS	--	--	NS	--	--	NS	--	--	NS	--	--
	CHLOROMETHANE	NS	--	--	NS	--	--	NS	--	--	NS	--	--
	CIS-1,2-DICHLOROETHENE	NS	--	--	NS	--	--	NS	--	--	NS	--	--
	DICHLORODIFLUOROMETHANE	NS	--	--	NS	--	--	NS	--	--	NS	--	--
	ETHYLBENZENE	NS	--	--	NS	--	--	NS	--	--	NS	--	--
	ISOPROPYLBENZENE	NS	--	--	NS	--	--	NS	--	--	NS	--	--
	M,P-XYLENES	NS	--	--	NS	--	--	NS	--	--	NS	--	--
	METHYL TERT-BUTYL ETHER	NS	--	--	NS	--	--	NS	--	--	NS	--	--
	METHYLENE CHLORIDE	NS	--	--	NS	--	--	NS	--	--	NS	--	--
	NAPHTHALENE	NS	--	--	NS	--	--	NS	--	--	NS	--	--
	N-BUTYLBENZENE	NS	--	--	NS	--	--	NS	--	--	NS	--	--
	N-PROPYLBENZENE	NS	--	--	NS	--	--	NS	--	--	NS	--	--
	O-XYLENE	NS	--	--	NS	--	--	NS	--	--	NS	--	--
	P-ISOPROPYLTOLUENE	NS	--	--	NS	--	--	NS	--	--	NS	--	--
	SEC-BUTYLBENZENE	NS	--	--	NS	--	--	NS	--	--	NS	--	--
	TERT-BUTYLBENZENE	NS	--	--	NS	--	--	NS	--	--	NS	--	--
	TETRACHLOROETHENE	NS	--	--	NS	--	--	NS	--	--	NS	--	--
	TOLUENE	NS	--	--	NS	--	--	NS	--	--	NS	--	--
TRANS-1,2-DICHLOROETHENE	NS	--	--	NS	--	--	NS	--	--	NS	--	--	
TRICHLOROETHENE	NS	--	--	NS	--	--	NS	--	--	NS	--	--	
TRICHLOROFUOROMETHANE	NS	--	--	NS	--	--	NS	--	--	NS	--	--	
VINYL CHLORIDE	NS	--	--	NS	--	--	NS	--	--	NS	--	--	
XYLENES	NS	--	--	NS	--	--	NS	--	--	NS	--	--	

Refer to notes at the end of the table.

Table 15
Analytical Data Table for KAFB-106MW2-S

Phase Designation		Phase 1 Recirculation									Phase 1 Passive		
Sample ID		106MW2S-P1R-102017			106MW2S-P1R-102517			106MW2S-P1R-110117			106MW2S-P1P-111617		
Sample Date		10/20/2017			10/25/2017			11/1/2017			11/16/2017		
Sample Purpose		REG			REG			REG			REG		
Chemical Class and Analytical Method ^a	Parameter	Result	Val Qual	LOQ	Result	Val Qual	LOQ	Result	Val Qual	LOQ	Result	Val Qual	LOQ
Microbial Community (cells/mL) QuantArray-Chlor	1,1 DCA Reductase (DCA)	NS	--	--	NS	--	--	NS	--	--	NS	--	--
	1,2 DCA Reductase (DCAR)	NS	--	--	NS	--	--	NS	--	--	NS	--	--
	BAV1 Vinyl Chloride Reductase (BVC)	NS	--	--	NS	--	--	NS	--	--	NS	--	--
	cer A Reductase	NS	--	--	NS	--	--	NS	--	--	NS	--	--
	Chloroform Reductase (CFR)	NS	--	--	NS	--	--	NS	--	--	NS	--	--
	Dehalobacter DCM (DCM)	NS	--	--	NS	--	--	NS	--	--	NS	--	--
	Dehalobacter spp. (DHBt)	NS	--	--	NS	--	--	NS	--	--	NS	--	--
	Dehalobium chloroercia (DECO)	NS	--	--	NS	--	--	NS	--	--	NS	--	--
	Dehalococcoides (DHC)	NS	--	--	NS	--	--	NS	--	--	NS	--	--
	Dehalogenimonas spp. (DHG)	NS	--	--	NS	--	--	NS	--	--	NS	--	--
	Desulfitobacterium spp. (DSB)	NS	--	--	NS	--	--	NS	--	--	NS	--	--
	Desulfuromonas spp. (DSM)	NS	--	--	NS	--	--	NS	--	--	NS	--	--
	Dichloromethane Dehalogenase (DCMA)	NS	--	--	NS	--	--	NS	--	--	NS	--	--
	Epoxyalkane Transferase (EtnE)	NS	--	--	NS	--	--	NS	--	--	NS	--	--
	Ethene Monooxygenase (EtnC)	NS	--	--	NS	--	--	NS	--	--	NS	--	--
	Methanogens (MGN)	NS	--	--	NS	--	--	NS	--	--	NS	--	--
	PCE Reductase (PCE-1)	NS	--	--	NS	--	--	NS	--	--	NS	--	--
	Phenol Hydroxylase (PHE)	NS	--	--	NS	--	--	NS	--	--	NS	--	--
	PMMO	NS	--	--	NS	--	--	NS	--	--	NS	--	--
	Soluble Methane Monooxygenase (SMMO)	NS	--	--	NS	--	--	NS	--	--	NS	--	--
	Sulfate Reducing Bacteria (APS)	NS	--	--	NS	--	--	NS	--	--	NS	--	--
	tceA Reductase (TCE)	NS	--	--	NS	--	--	NS	--	--	NS	--	--
	Toluene Dioxygenase (TOD)	NS	--	--	NS	--	--	NS	--	--	NS	--	--
	Toluene Monooxygenase (RMO)	NS	--	--	NS	--	--	NS	--	--	NS	--	--
	Toluene Monooxygenase 2 (RDEG)	NS	--	--	NS	--	--	NS	--	--	NS	--	--
	Total Eubacteria (EBAC)	NS	--	--	NS	--	--	NS	--	--	NS	--	--
	trans-1,2-DCE Reductase (TDR)	NS	--	--	NS	--	--	NS	--	--	NS	--	--
Trichlorobenzene Dioxygenase (TCBO)	NS	--	--	NS	--	--	NS	--	--	NS	--	--	
Vinyl Chloride Reductase (VCR)	NS	--	--	NS	--	--	NS	--	--	NS	--	--	
EDB (µg/L) EPA Method 8011	1,2-DIBROMOETHANE	NS	--	--	NS	--	--	NS	--	--	32.1		3.89
VFAs (mg/L) EPA Method 300m	ACETIC ACID	NS	--	--	8.59		1	NS	--	--	39.9		1
	BUTYRIC ACID	NS	--	--	ND	U	1	NS	--	--	ND	U	1
	FORMIC ACID	NS	--	--	ND	U	1	NS	--	--	ND	U	1
	LACTIC ACID	NS	--	--	ND	U	1	NS	--	--	ND	U	1
	PROPIONIC ACID	NS	--	--	ND	U	1	NS	--	--	1.04		1
	PYRUVIC ACID	NS	--	--	ND	U	1	NS	--	--	ND	U	1
	VALERIC ACID	NS	--	--	ND	U	1	NS	--	--	ND	U	1
Fluorometric (µg/L) Spectrofluorophotometry	FLUORESCEIN	3.547		0.01	4.53		0.01	7.517		0.01	5.964		0.01
Reduced Gases (µg/L) RSKSOP-175	ACETYLENE	NS	--	--	ND	U	10	NS	--	--	ND	U	10
	ETHANE	NS	--	--	ND	U	4	NS	--	--	ND	U	4
	ETHYLENE	NS	--	--	ND	U	5	NS	--	--	9.56		5
	METHANE	NS	--	--	ND	U	2	NS	--	--	30.1		2
	PROPANE	NS	--	--	ND	U	6	NS	--	--	ND	U	6
General Chemistry (mg/L) SM2320b, EPA Method 300, EPA Method 353.2, SM4500 Pe ^c	ALKALINITY	NS	--	--	325		1	NS	--	--	338		1
	BROMIDE	NS	--	--	0.527		0.125	NS	--	--	0.61		0.25
	CHLORIDE	NS	--	--	44.7		0.33	NS	--	--	45.2		0.66
	IODIDE	NS	--	--	ND	U	0.75	NS	--	--	ND	U	0.75
	NITRATE	NS	--	--	NA	--	--	NS	--	--	NA	--	--
	NITRITE	NS	--	--	NA	--	--	NS	--	--	NA	--	--

Table 15
Analytical Data Table for KAFB-106MW2-S

Phase Designation		Phase 1 Recirculation									Phase 1 Passive		
Sample ID		106MW2S-P1R-102017			106MW2S-P1R-102517			106MW2S-P1R-110117			106MW2S-P1P-111617		
Sample Date		10/20/2017			10/25/2017			11/1/2017			11/16/2017		
Sample Purpose		REG			REG			REG			REG		
Chemical Class and Analytical Method ^a	Parameter	Result	Val Qual	LOQ	Result	Val Qual	LOQ	Result	Val Qual	LOQ	Result	Val Qual	LOQ
General Chemistry (mg/L) SM2320b, EPA Method 300, EPA Method 353.2, SM4500 Pec	NITROGEN, NITRATE-NITRITE	NS	--	--	ND	U	0.375	NS	--	--	ND	U	0.375
	O-PHOSPHATE (AS P)	NS	--	--	0.107		0.02	NS	--	--	0.0281	J	0.02
	ORTHOPHOSPHATE	NS	--	--	NA	--	--	NS	--	--	NA	--	--
	PHOSPHORUS	NS	--	--	NA	--	--	NS	--	--	NA	--	--
	SULFATE	NS	--	--	15		1	NS	--	--	ND	U	2
Metals (mg/L) EPA Method 6010	LEAD	NS	--	--	NS	--	--	NS	--	--	NS	--	--
Dissolved Metals (mg/L) EPA Method 6010	IRON	NS	--	--	1.53		0.06	NS	--	--	1.77		0.06
	MANGANESE	NS	--	--	2.16		0.006	NS	--	--	2.48		0.006
δ2H (‰) Mass Spectrometry, USGS Reston, VA	DELTA2H	-91.61		-99	-90.59		-99	-85.76		-99	-87.39		-99
CSIA EDB δ13C (‰) Kuder et al, 2012	EDB δ	NS	--	--	NS	--	--	NS	--	--	NS	--	--
VOCs (µg/L) EPA Method 8260	1,1,2-TRICHLOROETHANE	NS	--	--	ND	U	50				ND	U	50
	1,2,4-TRICHLOROBENZENE	NS	--	--	NA	--	--	NS	--	--	NA	--	--
	1,2,4-TRIMETHYLBENZENE	NS	--	--	194		50	NS	--	--	159		50
	1,2-DIBROMOETHANE	NS	--	--	86.5	J	50	NS	--	--	37.7	J	50
	1,2-DICHLOROETHANE	NS	--	--	ND	U	50	NS	--	--	ND	U	50
	1,3,5-TRIMETHYLBENZENE	NS	--	--	74.2	J	50	NS	--	--	61.7	J	50
	2-BUTANONE	NS	--	--	ND	U	500	NS	--	--	ND	U	500
	2-CHLOROTOLUENE	NS	--	--	ND	U	50	NS	--	--	ND	U	50
	2-HEXANONE	NS	--	--	143	J	250	NS	--	--	ND	U	250
	4-METHYL-2-PENTANONE	NS	--	--	ND	U	250	NS	--	--	ND	U	250
	ACETONE	NS	--	--	701	J	500	NS	--	--	272	J-	500
	BENZENE	NS	--	--	2730		50	NS	--	--	2650		50
	CARBON DISULFIDE	NS	--	--	ND	U	50	NS	--	--	ND	U	50
	CHLOROMETHANE	NS	--	--	ND	U	50	NS	--	--	ND	U	50
	CIS-1,2-DICHLOROETHENE	NS	--	--	NA	--	--	NS	--	--	NA	--	--
	DICHLORODIFLUOROMETHANE	NS	--	--	ND	U	100	NS	--	--	ND	U	100
	ETHYLBENZENE	NS	--	--	512		50	NS	--	--	468		50
	ISOPROPYLBENZENE	NS	--	--	47	J	50	NS	--	--	90.2	J	50
	M,P-XYLENES	NS	--	--	NA	--	--	NS	--	--	NA	--	--
	METHYL TERT-BUTYL ETHER	NS	--	--	ND	U	50	NS	--	--	ND	U	50
	METHYLENE CHLORIDE	NS	--	--	ND	U	100	NS	--	--	ND	U	100
	NAPHTHALENE	NS	--	--	83.7	J	50	NS	--	--	68.1	J	50
	N-BUTYLBENZENE	NS	--	--	ND	U	50	NS	--	--	ND	U	50
	N-PROPYLBENZENE	NS	--	--	44.3	J	50	NS	--	--	31.7	J	50
	O-XYLENE	NS	--	--	NA	--	--	NS	--	--	NA	--	--
	P-ISOPROPYLTOLUENE	NS	--	--	118		50	NS	--	--	112		50
	SEC-BUTYLBENZENE	NS	--	--	ND	U	50	NS	--	--	ND	U	50
	TERT-BUTYLBENZENE	NS	--	--	ND	U	50	NS	--	--	ND	U	50
	TETRACHLOROETHENE	NS	--	--	NA	--	--	NS	--	--	NA	--	--
	TOLUENE	NS	--	--	4740		50	NS	--	--	3580		50
TRANS-1,2-DICHLOROETHENE	NS	--	--	NA	--	--	NS	--	--	NA	--	--	
TRICHLOROETHENE	NS	--	--	ND	U	50	NS	--	--	38.2	J	50	
TRICHLOROFUOROMETHANE	NS	--	--	ND	U	100	NS	--	--	ND	U	100	
VINYL CHLORIDE	NS	--	--	NA	--	--	NS	--	--	NA	--	--	
XYLENES	NS	--	--	1970		150	NS	--	--	1680		150	

Refer to notes at the end of the table.

Table 15
Analytical Data Table for KAFB-106MW2-S

Phase Designation		Phase 1 Passive			Phase 2 Recirculation								
Sample ID		106MW2S-P1P-112817			106MW2S-P2R-010918			106MW2S-P2R-011618			106MW2S-P2R-012418		
Sample Date		11/28/2017			1/9/2018			1/16/2018			1/24/2018		
Sample Purpose		REG			REG			REG			REG		
Chemical Class and Analytical Method ^a	Parameter	Result	Val Qual	LOQ	Result	Val Qual	LOQ	Result	Val Qual	LOQ	Result	Val Qual	LOQ
Microbial Community (cells/mL) QuantArray-Chlor	1,1 DCA Reductase (DCA)	ND	U	5	NS	--	--	NS	--	--	ND	U	5.7
	1,2 DCA Reductase (DCAR)	ND	U	5	NS	--	--	NS	--	--	ND	U	5.7
	BAV1 Vinyl Chloride Reductase (BVC)	ND	U	0.5	NS	--	--	NS	--	--	ND	U	0.6
	cer A Reductase	NA	--	--	NS	--	--	NS	--	--	ND	U	5.7
	Chloroform Reductase (CFR)	ND	U	5	NS	--	--	NS	--	--	ND	U	5.7
	Dehalobacter DCM (DCM)	ND	U	5	NS	--	--	NS	--	--	626		5.7
	Dehalobacter spp. (DHBt)	15000		5	NS	--	--	NS	--	--	67200		5.7
	Dehalobium chloroeracia (DECO)	4610		5	NS	--	--	NS	--	--	12300		5.7
	Dehalococcoides (DHC)	0.5	J	0.5	NS	--	--	NS	--	--	ND	U	0.6
	Dehalogenimonas spp. (DHG)	ND	U	5	NS	--	--	NS	--	--	370		5.7
	Desulfitobacterium spp. (DSB)	43100		5	NS	--	--	NS	--	--	39800		5.7
	Desulfuromonas spp. (DSM)	9.8		5	NS	--	--	NS	--	--	86.6		5.7
	Dichloromethane Dehalogenase (DCMA)	ND	U	5	NS	--	--	NS	--	--	ND	U	5.7
	Epoxyalkane Transferase (EtnE)	ND	U	5	NS	--	--	NS	--	--	ND	U	5.7
	Ethene Monooxygenase (EtnC)	ND	U	5	NS	--	--	NS	--	--	ND	U	5.7
	Methanogens (MGN)	1470		5	NS	--	--	NS	--	--	91.2		5.7
	PCE Reductase (PCE-1)	NA	--	--	NS	--	--	NS	--	--	ND	U	5.7
	Phenol Hydroxylase (PHE)	9650		5	NS	--	--	NS	--	--	16600		5.7
	PMMO	ND	U	5	NS	--	--	NS	--	--	NA	--	--
	Soluble Methane Monooxygenase (SMMO)	ND	U	5	NS	--	--	NS	--	--	418		5.7
	Sulfate Reducing Bacteria (APS)	124000		5	NS	--	--	NS	--	--	140000		5.7
	tceA Reductase (TCE)	ND	U	0.5	NS	--	--	NS	--	--	ND	U	0.6
	Toluene Dioxygenase (TOD)	ND	U	5	NS	--	--	NS	--	--	ND	U	5.7
	Toluene Monooxygenase (RMO)	14600		5	NS	--	--	NS	--	--	14000		5.7
	Toluene Monooxygenase 2 (RDEG)	6380		5	NS	--	--	NS	--	--	6110		5.7
	Total Eubacteria (EBAC)	4850000		5	NS	--	--	NS	--	--	4160000		5.7
	trans-1,2-DCE Reductase (TDR)	NA	--	--	NS	--	--	NS	--	--	ND	U	5.7
	Trichlorobenzene Dioxygenase (TCBO)	ND	U	5	NS	--	--	NS	--	--	ND	U	5.7
Vinyl Chloride Reductase (VCR)	ND	U	0.5	NS	--	--	NS	--	--	ND	U	0.6	
EDB (µg/L) EPA Method 8011	1,2-DIBROMOETHANE	15		1.92	54.9		1.9	77.7		1.91	68.1		1.92
VFAs (mg/L) EPA Method 300m	ACETIC ACID	67.8		1	75.2		1	97.2		1	33.8		1
	BUTYRIC ACID	2.95		1	ND	U	1	ND	U	1	0.39	J	1
	FORMIC ACID	ND	U	1	ND	U	1	ND	U	1	ND	U	1
	LACTIC ACID	ND	U	1	2.04		1	ND	U	1	0.52	J	1
	PROPIONIC ACID	2.78		1	13.2		1	24.4		1	10		1
	PYRUVIC ACID	ND	U	1	ND	U	1	ND	U	1	ND	U	1
	VALERIC ACID	ND	U	1.00	ND	U	1.00	ND	U	1	ND	U	1
Fluorometric (µg/L) Spectrofluorophotometry	FLUORESCEIN	5.133		0.01	NS	--	--	NS	--	--	NS	--	--
Reduced Gases (µg/L) RSKSOP-175	ACETYLENE	ND	U	10	ND	U	10	ND	U	10	ND	U	10
	ETHANE	ND	U	4	2.02	J	4	1.8	J	4	1.59	J	4
	ETHYLENE	6.53		5	6.34		5	6.12		5	5.73		5
	METHANE	351		2	11.3		2	8.47		2	12.4		2
	PROPANE	ND	U	6	1.95	J	6	ND	U	6	ND	U	6
General Chemistry (mg/L) SM2320b, EPA Method 300, EPA Method 353.2, SM4500 Pe ^c	ALKALINITY	349		1	372	J-	1	343		1	334		1
	BROMIDE	0.751		0.25	0.465	J	0.25	0.608		0.25	0.553		0.25
	CHLORIDE	45.6		0.66	50.2		0.66	52.5	J+	0.66	49		0.66
	IODIDE	ND	U	0.75	9.4		0.75	16		0.75	17		0.75
	NITRATE	NA	--	--	NA	--	--	NA	--	--	NA	--	--
	NITRITE	NA	--	--	NA	--	--	NA	--	--	NA	--	--

Table 15
Analytical Data Table for KAFB-106MW2-S

Phase Designation		Phase 1 Passive			Phase 2 Recirculation								
Sample ID		106MW2S-P1P-112817			106MW2S-P2R-010918			106MW2S-P2R-011618			106MW2S-P2R-012418		
Sample Date		11/28/2017			1/9/2018			1/16/2018			1/24/2018		
Sample Purpose		REG			REG			REG			REG		
Chemical Class and Analytical Method ^a	Parameter	Result	Val Qual	LOQ	Result	Val Qual	LOQ	Result	Val Qual	LOQ	Result	Val Qual	LOQ
General Chemistry (mg/L) SM2320b, EPA Method 300, EPA Method 353.2, SM4500 Pec	NITROGEN, NITRATE-NITRITE	ND	U	0.375	ND	U	0.375	ND	U	0.375	ND	U	0.375
	O-PHOSPHATE (AS P)	0.0153	J	0.02	0.113		0.02	0.285		0.02	0.718		0.02
	ORTHOPHOSPHATE	NA	--	--	NA	--	--	NA	--	--	NA	--	--
	PHOSPHORUS	NA	--	--	NA	--	--	NA	--	--	NA	--	--
	SULFATE	ND	U	2	1.96	J	2	1.16	J+	2	ND	U	2
Metals (mg/L) EPA Method 6010	LEAD	NS	--	--	NS	--	--	NS	--	--	NS	--	--
Dissolved Metals (mg/L) EPA Method 6010	IRON	4.17		0.06	3.85	J-	0.06	4.08		0.06	4.93	J-	0.06
	MANGANESE	3.14		0.006	4.99		0.006	5.91		0.006	6.81	J-	0.006
δ2H (‰) Mass Spectrometry, USGS Reston, VA	DELTA2H	-86.24		-99	NS	--	--	NS	--	--	NS	--	--
CSIA EDB δ13C (‰) Kuder et al, 2012	EDB δ	-1.6 ±2‰	--	--	NS	--	--	NS	--	--	-11.7 ±2‰	--	--
VOCs (µg/L) EPA Method 8260	1,1,2-TRICHLOROETHANE	ND	U	25	ND	U	25	ND	U	50	ND	U	50
	1,2,4-TRICHLOROBENZENE	NA	--	--	NA	--	--	NA	--	--	NA	--	--
	1,2,4-TRIMETHYLBENZENE	203		25	253		25	258		50	291		50
	1,2-DIBROMOETHANE	19.3	J	25	71.1		25	66.3	J	50	55.4	J	50
	1,2-DICHLOROETHANE	ND	U	25	ND	U	25	ND	U	50	ND	U	50
	1,3,5-TRIMETHYLBENZENE	76.7		25	98.8		25	98.9	J	50	106		50
	2-BUTANONE	ND	U	250	ND	U	250	ND	U	500	ND	U	500
	2-CHLOROTOLUENE	ND	U	25	ND	U	25	ND	U	50	ND	U	50
	2-HEXANONE	ND	U	125	120	J	125	ND	U	250	ND	U	250
	4-METHYL-2-PENTANONE	ND	U	125	88.6	J	125	ND	U	250	ND	U	250
	ACETONE	177	J	250	371	J	250	450	J	500	256	J	500
	BENZENE	2870		25	3240		25	3430		50	3820		50
	CARBON DISULFIDE	ND	U	25	ND	U	25	ND	U	50	ND	U	50
	CHLOROMETHANE	ND	U	25	ND	U	25	ND	U	50	ND	U	50
	CIS-1,2-DICHLOROETHENE	NA	--	--	NA	--	--	NA	--	--	NA	--	--
	DICHLORODIFLUOROMETHANE	ND	U	50	ND	U	50	ND	U	100	ND	U	100
	ETHYLBENZENE	582		25	729		25	739		50	912		50
	ISOPROPYLBENZENE	132		25	77.5		25	73.6	J	50	101		50
	M,P-XYLENES	NA	--	--	NA	--	--	NA	--	--	NA	--	--
	METHYL TERT-BUTYL ETHER	ND	U	25	ND	U	25	ND	U	50	ND	U	50
	METHYLENE CHLORIDE	ND	U	50	ND	U	50	ND	U	100	ND	U	100
	NAPHTHALENE	68.5		25	90.1		25	79.4	J	50	88.8	J	50
	N-BUTYLBENZENE	ND	U	25	12.6	J	25	ND	U	50	ND	U	50
	N-PROPYLBENZENE	43.5	J	25	62.7		25	58.6	J	50	71.5	J	50
	O-XYLENE	NA	--	--	NA	--	--	NA	--	--	NA	--	--
	P-ISOPROPYLTOLUENE	125		25	146		25	138		50	ND	U	50
	SEC-BUTYLBENZENE	ND	U	25	14.9	J	25	ND	U	50	ND	U	50
	TERT-BUTYLBENZENE	ND	U	25	ND	U	25	ND	U	50	ND	U	50
	TETRACHLOROETHENE	NA	--	--	NA	--	--	NA	--	--	NA	--	--
	TOLUENE	4210		25	6070		25	7440		50	8920		50
TRANS-1,2-DICHLOROETHENE	NA	--	--	NA	--	--	NA	--	--	NA	--	--	
TRICHLOROETHENE	ND	U	25	ND	U	25	ND	U	50	ND	U	50	
TRICHLOROFLUOROMETHANE	ND	U	50	ND	U	50	ND	U	100	ND	U	100	
VINYL CHLORIDE	NA	--	--	NA	--	--	NA	--	--	NA	--	--	
XYLENES	2070		75	2240		75	2430		150	2900		150	

Refer to notes at the end of the table.

Table 15
Analytical Data Table for KAFB-106MW2-S

Phase Designation		Phase 2 Passive												
Sample ID		106MW2S-P2P-030718			106MW2S-P2P-041018			106MW2S-P2P-041018-FD			106MW2S-P2P-050918			
Sample Date		3/7/2018			4/10/2018			4/10/2018			5/9/2018			
Sample Purpose		REG			REG			FD			REG			
Chemical Class and Analytical Method ^a	Parameter	Result	Val Qual	LOQ	Result	Val Qual	LOQ	Result	Val Qual	LOQ	Result	Val Qual	LOQ	
Microbial Community (cells/mL) QuantArray-Chlor	1,1 DCA Reductase (DCA)	NS	--	--	NS	--	--	NS	--	--	ND	U	9.4	
	1,2 DCA Reductase (DCAR)	NS	--	--	NS	--	--	NS	--	--	ND	U	9.4	
	BAV1 Vinyl Chloride Reductase (BVC)	NS	--	--	NS	--	--	NS	--	--	ND	U	0.9	
	cer A Reductase	NS	--	--	NS	--	--	NS	--	--	ND	U	9.4	
	Chloroform Reductase (CFR)	NS	--	--	NS	--	--	NS	--	--	ND	U	9.4	
	Dehalobacter DCM (DCM)	NS	--	--	NS	--	--	NS	--	--	ND	U	9.4	
	Dehalobacter spp. (DHBt)	NS	--	--	NS	--	--	NS	--	--	58500			9.4
	Dehalobium chloroeracia (DECO)	NS	--	--	NS	--	--	NS	--	--	5330			9.4
	Dehalococcoides (DHC)	NS	--	--	NS	--	--	NS	--	--	ND	U		0.9
	Dehalogenimonas spp. (DHG)	NS	--	--	NS	--	--	NS	--	--	6490			9.4
	Desulfitobacterium spp. (DSB)	NS	--	--	NS	--	--	NS	--	--	23300			9.4
	Desulfuromonas spp. (DSM)	NS	--	--	NS	--	--	NS	--	--	122			9.4
	Dichloromethane Dehalogenase (DCMA)	NS	--	--	NS	--	--	NS	--	--	ND	U		9.4
	Epoxyalkane Transferase (EtnE)	NS	--	--	NS	--	--	NS	--	--	48.9			9.4
	Ethene Monooxygenase (EtnC)	NS	--	--	NS	--	--	NS	--	--	ND	U		9.4
	Methanogens (MGN)	NS	--	--	NS	--	--	NS	--	--	77100			9.4
	PCE Reductase (PCE-1)	NS	--	--	NS	--	--	NS	--	--	ND	U		9.4
	Phenol Hydroxylase (PHE)	NS	--	--	NS	--	--	NS	--	--	4870			9.4
	PMMO	NS	--	--	NS	--	--	NS	--	--	NA	--	--	--
	Soluble Methane Monooxygenase (SMMO)	NS	--	--	NS	--	--	NS	--	--	303			9.4
Sulfate Reducing Bacteria (APS)	NS	--	--	NS	--	--	NS	--	--	76000			9.4	
tceA Reductase (TCE)	NS	--	--	NS	--	--	NS	--	--	ND	U		0.9	
Toluene Dioxygenase (TOD)	NS	--	--	NS	--	--	NS	--	--	ND	U		9.4	
Toluene Monooxygenase (RMO)	NS	--	--	NS	--	--	NS	--	--	4290			9.4	
Toluene Monooxygenase 2 (RDEG)	NS	--	--	NS	--	--	NS	--	--	3240			9.4	
Total Eubacteria (EBAC)	NS	--	--	NS	--	--	NS	--	--	9060000			9.4	
trans-1,2-DCE Reductase (TDR)	NS	--	--	NS	--	--	NS	--	--	ND	U		9.4	
Trichlorobenzene Dioxygenase (TCBO)	NS	--	--	NS	--	--	NS	--	--	ND	U		9.4	
Vinyl Chloride Reductase (VCR)	NS	--	--	NS	--	--	NS	--	--	ND	U		0.9	
EDB (µg/L) EPA Method 8011	1,2-DIBROMOETHANE	8.25	J+	1.92	0.154		0.0192	0.139		0.0191	0.0331	J	0.0189	
VFAs (mg/L) EPA Method 300m	ACETIC ACID	151		10	113.5		10	118.4		10	15.7		1	
	BUTYRIC ACID	11.8		1	ND	U	1	ND	U	1	ND	U	1	
	FORMIC ACID	ND	U	1	2.1		1	2.8		1	ND	U	1	
	LACTIC ACID	ND	U	1	ND	U	1	1		1	0.75	J	1	
	PROPIONIC ACID	32		1	25.8		10	27.9		10	12.8		1	
	PYRUVIC ACID	1.1		1	ND	U	1	ND	U	1	ND	U	1	
	VALERIC ACID	2.60		1	1.10		1	2.30		1	ND	U	1	
Fluorometric (µg/L) Spectrofluorophotometry	FLUORESCEIN	NS	--	--	NS	--	--	NS	--	--	NS	--	--	
Reduced Gases (µg/L) RSKSOP-175	ACETYLENE	ND	U	10	ND	U	10	ND	U	10	ND	U	10	
	ETHANE	1.7	J	4	1.02	J	4	0.97	J	4	0.95	J	4	
	ETHYLENE	8.9		5	5.5		5	5.02		5	3.45	J	5	
	METHANE	3110		20	11800		20	11600		20	11800		20	
	PROPANE	1.7	J	6	1.39	J	6	1.2	J	6	ND	U	6	
General Chemistry (mg/L) SM2320b, EPA Method 300, EPA Method 353.2, SM4500 Pe ^c	ALKALINITY	375		1	399		1	382		1	517		1	
	BROMIDE	0.798	J	0.625	0.561		0.25	0.567		0.25	0.556		0.25	
	CHLORIDE	48		1.65	49.5		0.66	49.8		0.66	52.3		0.66	
	IODIDE	19		0.75	18		0.75	19		0.75	21		1.5	
	NITRATE	NA	--	--	ND	U	0.2	ND	U	0.2	ND	U	0.2	
	NITRITE	NA	--	--	ND	U	0.2	ND	U	0.2	ND	U	0.2	

Table 15
Analytical Data Table for KAFB-106MW2-S

Phase Designation		Phase 2 Passive											
Sample ID		106MW2S-P2P-030718			106MW2S-P2P-041018			106MW2S-P2P-041018-FD			106MW2S-P2P-050918		
Sample Date		3/7/2018			4/10/2018			4/10/2018			5/9/2018		
Sample Purpose		REG			REG			FD			REG		
Chemical Class and Analytical Method ^a	Parameter	Result	Val Qual	LOQ	Result	Val Qual	LOQ	Result	Val Qual	LOQ	Result	Val Qual	LOQ
General Chemistry (mg/L) SM2320b, EPA Method 300, EPA Method 353.2, SM4500 Pec	NITROGEN, NITRATE-NITRITE	ND	U	0.375	NA	--	--	NA	--	--	NA	--	--
	O-PHOSPHATE (AS P)	0.846	J-	0.02	0.623		0.02	0.571		0.04	0.334		0.02
	ORTHOPHOSPHATE	NA	--	--	NA	--	--	NA	--	--	NA	--	--
	PHOSPHORUS	NA	--	--	NA	--	--	NA	--	--	NA	--	--
	SULFATE	ND	U	5	ND	U	2	ND	U	2	ND	U	2
Metals (mg/L) EPA Method 6010	LEAD	NS	--	--	NS	--	--	NS	--	--	NS	--	--
Dissolved Metals (mg/L) EPA Method 6010	IRON	11		0.06	12.3	J-	0.06	12.1	J-	0.06	13.4		0.06
	MANGANESE	8.79		0.006	9.47	J+	0.006	9.42	J+	0.006	9.26		0.006
δ ² H (‰) Mass Spectrometry, USGS Reston, VA	DELTA2H	NS	--	--	NS	--	--	NS	--	--	NS	--	--
CSIA EDB δ ¹³ C (‰) Kuder et al, 2012	EDB δ	NS	--	--	NS	--	--	NS	--	--	NS	--	--
VOCs (µg/L) EPA Method 8260	1,1,2-TRICHLOROETHANE	ND	U	50	ND	U	50	ND	U	50	ND	U	2.5
	1,2,4-TRICHLOROBENZENE	NA	--	--	NA	--	--	NA	--	--	NA	--	--
	1,2,4-TRIMETHYLBENZENE	193		50	194		50	189		50	185		2.5
	1,2-DIBROMOETHANE	ND	U	50	ND	U	50	ND	U	50	ND	U	2.5
	1,2-DICHLOROETHANE	ND	U	50	ND	U	50	ND	U	50	ND	U	2.5
	1,3,5-TRIMETHYLBENZENE	78.2	J	50	70.3	J	50	69.2	J	50	65.8		2.5
	2-BUTANONE	ND	U	500	ND	U	500	ND	U	500	45.1	J	25
	2-CHLOROTOLUENE	ND	U	50	ND	U	50	ND	U	50	ND	U	2.5
	2-HEXANONE	ND	U	250	ND	U	250	ND	U	250	63.4		12.5
	4-METHYL-2-PENTANONE	ND	U	250	ND	U	250	ND	U	250	52.8		12.5
	ACETONE	ND	U	500	379	J	500	343	J	500	65.5		25
	BENZENE	3240		50	2360		50	2210		50	1680		12.5
	CARBON DISULFIDE	ND	U	50	ND	U	50	ND	U	50	ND	U	2.5
	CHLOROMETHANE	ND	U	50	ND	U	50	ND	U	50	ND	U	2.5
	CIS-1,2-DICHLOROETHENE	NA	--	--	NA	--	--	NA	--	--	NA	--	--
	DICHLORODIFLUOROMETHANE	ND	U	100	ND	U	100	ND	U	100	ND	U	5
	ETHYLBENZENE	677		50	628		50	591		50	506	J-	2.5
	ISOPROPYLBENZENE	139		50	150		50	150		50	134		2.5
	M,P-XYLENES	NA	--	--	NA	--	--	NA	--	--	NA	--	--
	METHYL TERT-BUTYL ETHER	ND	U	50	ND	U	50	ND	U	50	ND	U	2.5
	METHYLENE CHLORIDE	ND	U	100	ND	U	100	ND	U	100	ND	U	5
	NAPHTHALENE	54.3	J	50	78.6	J	50	80.1	J	50	89.6		2.5
	N-BUTYLBENZENE	ND	U	50	ND	U	50	ND	U	50	7.13		2.5
	N-PROPYLBENZENE	43.4	J	50	52.4	J	50	50.4	J	50	47.8		2.5
	O-XYLENE	NA	--	--	NA	--	--	NA	--	--	NA	--	--
	P-ISOPROPYLTOLUENE	ND	U	50	83.4	J	50	81.7	J	50	77.4		2.5
	SEC-BUTYLBENZENE	ND	U	50	ND	U	50	ND	U	50	8.23		2.5
	TERT-BUTYLBENZENE	ND	U	50	ND	U	50	ND	U	50	ND	U	2.5
	TETRACHLOROETHENE	NA	--	--	NA	--	--	NA	--	--	NA	--	--
	TOLUENE	6980		50	5440		50	5190		50	3600		12.5
TRANS-1,2-DICHLOROETHENE	NA	--	--	NA	--	--	NA	--	--	NA	--	--	
TRICHLOROETHENE	ND	U	50	ND	U	50	ND	U	50	ND	U	2.5	
TRICHLOROFUOROMETHANE	ND	U	100	ND	U	100	ND	U	100	ND	U	5	
VINYL CHLORIDE	NA	--	--	NA	--	--	NA	--	--	NA	--	--	
XYLENES	2160		150	1870		150	1810		150	1510	J-	7.5	

Refer to notes at the end of the table.

Table 15
Analytical Data Table for KAFB-106MW2-S

Phase Designation		Phase 2 Passive			Phase 3 Recirculation									
Sample ID		106MW2S-P2P-061418			106MW2S-P3R-080718			106MW2S-P3R-081518			106MW2S-P3R-082118			
Sample Date		6/14/2018			8/7/2018			8/15/2018			8/21/2018			
Sample Purpose		REG			REG			REG			REG			
Chemical Class and Analytical Method ^a	Parameter	Result	Val Qual	LOQ	Result	Val Qual	LOQ	Result	Val Qual	LOQ	Result	Val Qual	LOQ	
Microbial Community (cells/mL) QuantArray-Chlor	1,1 DCA Reductase (DCA)	NS	--	--	NS	--	--	NS	--	--	ND	U	5	
	1,2 DCA Reductase (DCAR)	NS	--	--	NS	--	--	NS	--	--	ND	U	5	
	BAV1 Vinyl Chloride Reductase (BVC)	NS	--	--	NS	--	--	NS	--	--	ND	U	0.5	
	cer A Reductase	NS	--	--	NS	--	--	NS	--	--	ND	U	5	
	Chloroform Reductase (CFR)	NS	--	--	NS	--	--	NS	--	--	ND	U	5	
	Dehalobacter DCM (DCM)	NS	--	--	NS	--	--	NS	--	--	954		5	
	Dehalobacter spp. (DHBt)	NS	--	--	NS	--	--	NS	--	--	51000		5	
	Dehalobium chloroeracia (DECO)	NS	--	--	NS	--	--	NS	--	--	21100		5	
	Dehalococcoides (DHC)	NS	--	--	NS	--	--	NS	--	--	ND	U	0.5	
	Dehalogenimonas spp. (DHG)	NS	--	--	NS	--	--	NS	--	--	ND	U	5	
	Desulfitobacterium spp. (DSB)	NS	--	--	NS	--	--	NS	--	--	127000		5	
	Desulfuromonas spp. (DSM)	NS	--	--	NS	--	--	NS	--	--	36.3		5	
	Dichloromethane Dehalogenase (DCMA)	NS	--	--	NS	--	--	NS	--	--	ND	U	5	
	Epoxyalkane Transferase (EtnE)	NS	--	--	NS	--	--	NS	--	--	831		5	
	Ethene Monooxygenase (EtnC)	NS	--	--	NS	--	--	NS	--	--	ND	U	5	
	Methanogens (MGN)	NS	--	--	NS	--	--	NS	--	--	893		5	
	PCE Reductase (PCE-1)	NS	--	--	NS	--	--	NS	--	--	ND	U	5	
	Phenol Hydroxylase (PHE)	NS	--	--	NS	--	--	NS	--	--	41200		5	
	PMMO	NS	--	--	NS	--	--	NS	--	--	NA	--	--	
	EDB (µg/L) EPA Method 8011	Soluble Methane Monooxygenase (SMMO)	NS	--	--	NS	--	--	NS	--	--	198		5
Sulfate Reducing Bacteria (APS)		NS	--	--	NS	--	--	NS	--	--	238000		5	
tceA Reductase (TCE)		NS	--	--	NS	--	--	NS	--	--	ND	U	0.5	
Toluene Dioxygenase (TOD)		NS	--	--	NS	--	--	NS	--	--	152		5	
Toluene Monooxygenase (RMO)		NS	--	--	NS	--	--	NS	--	--	269000		5	
Toluene Monooxygenase 2 (RDEG)		NS	--	--	NS	--	--	NS	--	--	23600		5	
Total Eubacteria (EBAC)		NS	--	--	NS	--	--	NS	--	--	22300000		5	
trans-1,2-DCE Reductase (TDR)		NS	--	--	NS	--	--	NS	--	--	ND	U	5	
Trichlorobenzene Dioxygenase (TCBO)		NS	--	--	NS	--	--	NS	--	--	ND	U	5	
Vinyl Chloride Reductase (VCR)		NS	--	--	NS	--	--	NS	--	--	ND	U	0.5	
1,2-DIBROMOETHANE		ND	U	0.0191	NS	--	--	8.5		0.031	6.7	J	0.029	
VFAs (mg/L) EPA Method 300m		ACETIC ACID	4.7	J	1	80.2		10	102.2		10	60.8		10
		BUTYRIC ACID	ND	UJ	1	ND	U	1	ND	U	1	ND	U	1
	FORMIC ACID	ND	UJ	1	1.6	J	10	ND	U	1	1	J	10	
	LACTIC ACID	0.4	J	1	3.4	J	10	0.6	J	1	1.5		1	
	PROPIONIC ACID	ND	UJ	1	29.9		10	43.6		10	56.3		10	
	PYRUVIC ACID	ND	UJ	1	ND	U	1	ND	U	1	ND	U	1	
	VALERIC ACID	ND	UJ	1	ND	U	1.00	ND	U	1.00	ND	U	1	
Fluorometric (µg/L) Spectrofluorophotometry	FLUORESCEIN	NS	--	--	NS	--	--	NS	--	--	NS	--	--	
Reduced Gases (µg/L) RSKSOP-175	ACETYLENE	ND	UJ	10	ND	U	10	ND	U	10	ND	U	10	
	ETHANE	0.9	J	4	2.1		4	1.8	J	4	2	J	4	
	ETHYLENE	2.6	J	5	8.4		5	11.1		5	11.1		5	
	METHANE	10800	J	20	4728.7		2	4434.8		2	5542.2		2	
	PROPANE	1.1	J	6	2.9	J	6	2.3	J	6	2.4	J	6	
General Chemistry (mg/L) SM2320b, EPA Method 300, EPA Method 353.2, SM4500 Pe ^c	ALKALINITY	526	J-	1	NA	--	--	390		5	420		5	
	BROMIDE	0.412	J	0.625	NA	--	--	1.3		0.5	1.4		0.5	
	CHLORIDE	52.7		1.65	NA	--	--	52		0.5	52		0.5	
	IODIDE	19		1.5	3.8		0.75	4.2		0.75	4.1		0.75	
	NITRATE	ND	U	0.5	NA	--	--	NA	--	--	NA	--	--	
	NITRITE	ND	U	0.5	NA	--	--	NA	--	--	NA	--	--	

Table 15
Analytical Data Table for KAFB-106MW2-S

Phase Designation		Phase 2 Passive			Phase 3 Recirculation								
Sample ID		106MW2S-P2P-061418			106MW2S-P3R-080718			106MW2S-P3R-081518			106MW2S-P3R-082118		
Sample Date		6/14/2018			8/7/2018			8/15/2018			8/21/2018		
Sample Purpose		REG			REG			REG			REG		
Chemical Class and Analytical Method ^a	Parameter	Result	Val Qual	LOQ	Result	Val Qual	LOQ	Result	Val Qual	LOQ	Result	Val Qual	LOQ
General Chemistry (mg/L) SM2320b, EPA Method 300, EPA Method 353.2, SM4500 Pec	NITROGEN, NITRATE-NITRITE	NA	--	--	NA	--	--	0.099		0.05	ND		0.05
	O-PHOSPHATE (AS P)	0.399		0.04	NA	--	--	NA	--	--	NA	--	--
	ORTHOPHOSPHATE	NA	--	--	NA	--	--	ND	U	0.15	0.15	J	0.15
	PHOSPHORUS	NA	--	--	NA	--	--	NA	--	--	NA	--	--
	SULFATE	ND	U	5	NA	--	--	0.89	J	1	2.9		1
Metals (mg/L) EPA Method 6010	LEAD	NS	--	--	NS	--	--	NS	--	--	NS	--	--
Dissolved Metals (mg/L) EPA Method 6010	IRON	13		0.06	NA	--	--	8.2		0.05	7.9		0.05
	MANGANESE	9.33		0.006	NA	--	--	10		0.003	10		0.003
δ2H (‰) Mass Spectrometry, USGS Reston, VA	DELTA2H	NS	--	--	NS	--	--	NS	--	--	NS	--	--
CSIA EDB δ13C (‰) Kuder et al, 2012	EDB δ	NS	--	--	NS	--	--	NS	--	--	-9.05 ±1.5‰	--	--
VOCs (µg/L) EPA Method 8260	1,1,2-TRICHLOROETHANE	ND	U	50				ND	U	25	ND	U	10
	1,2,4-TRICHLOROBENZENE	NA	--	--	NA	--	--	NA	--	--	NA	--	--
	1,2,4-TRIMETHYLBENZENE	218		50	NA	--	--	300		50	210		20
	1,2-DIBROMOETHANE	ND	U	50	NA	--	--	ND	U	50	ND	U	20
	1,2-DICHLOROETHANE	ND	U	50	NA	--	--	ND	U	50	ND	U	20
	1,3,5-TRIMETHYLBENZENE	78.4	J	50	NA	--	--	100		25	81		10
	2-BUTANONE	ND	U	500	NA	--	--	ND	U	500	ND	U	200
	2-CHLOROTOLUENE	ND	U	50	NA	--	--	ND	U	25	ND	U	10
	2-HEXANONE	ND	U	250	NA	--	--	ND	U	250	67	J	100
	4-METHYL-2-PENTANONE	ND	U	250	NA	--	--	ND	U	250	54	J	100
	ACETONE	ND	U	500	NA	--	--	ND	U	500	200		200
	BENZENE	2640		50	NA	--	--	3600		50	2700		20
	CARBON DISULFIDE	ND	U	50	NA	--	--	ND	U	100	ND	U	40
	CHLOROMETHANE	ND	U	50	NA	--	--	ND	U	50	ND	U	20
	CIS-1,2-DICHLOROETHENE	NA	--	--	NA	--	--	NA	--	--	NA	--	--
	DICHLORODIFLUOROMETHANE	ND	U	100	NA	--	--	860		50	650		20
	ETHYLBENZENE	691		50	NA	--	--	89		50	71		20
	ISOPROPYLBENZENE	183		50	NA	--	--	89		50	71		20
	M,P-XYLENES	NA	--	--	NA	--	--	NA	--	--	NA	--	--
	METHYL TERT-BUTYL ETHER	ND	U	50	NA	--	--	ND	U	25	ND	U	10
	METHYLENE CHLORIDE	ND	U	100	NA	--	--	ND	U	250	ND	U	100
	NAPHTHALENE	69.1	J	50	NA	--	--	140	J	250	110		100
	N-BUTYLBENZENE	ND	U	50	NA	--	--	ND	U	50	11	J	20
	N-PROPYLBENZENE	52.4	J	50	NA	--	--	72		50	57		20
	O-XYLENE	NA	--	--	NA	--	--	NA	--	--	NA	--	--
	P-ISOPROPYLTOLUENE	87.7	J	50	NA	--	--	110		50	88		20
	SEC-BUTYLBENZENE	ND	U	50	NA	--	--	ND	U	50	10	J	20
	TERT-BUTYLBENZENE	ND	U	50	NA	--	--	ND	U	50	ND	U	20
	TETRACHLOROETHENE	NA	--	--	NA	--	--	NA	--	--	NA	--	--
	TOLUENE	6020		50	NA	--	--	8000		50	6000		50
TRANS-1,2-DICHLOROETHENE	NA	--	--	NA	--	--	NA	--	--	NA	--	--	
TRICHLOROETHENE	82.5	J	50	NA	--	--	ND	U	50	ND	U	20	
TRICHLOROFUOROMETHANE	ND	U	100	NA	--	--	ND	U	50	ND	U	20	
VINYL CHLORIDE	NA	--	--	NA	--	--	NA	--	--	NA	--	--	
XYLENES	2240		150	NA	--	--	2800		25	2100		10	

Refer to notes at the end of the table.

Table 15
Analytical Data Table for KAFB-106MW2-S

Phase Designation		Phase 3 Recirculation			Phase 3 Passive								
Sample ID		106MW2S-P3R-082818			106MW2S-P3P-091118			106MW2S-P3P-100218			106MW2S-P3P-111518		
Sample Date		8/28/2018			9/11/2018			10/2/2018			11/15/2018		
Sample Purpose		REG			REG			REG			REG		
Chemical Class and Analytical Method ^a	Parameter	Result	Val Qual	LOQ	Result	Val Qual	LOQ	Result	Val Qual	LOQ	Result	Val Qual	LOQ
Microbial Community (cells/mL) QuantArray-Chlor	1,1 DCA Reductase (DCA)	NS	--	--	NS	--	--	NS	--	--	ND	U	26.3
	1,2 DCA Reductase (DCAR)	NS	--	--	NS	--	--	NS	--	--	ND	U	26.3
	BAV1 Vinyl Chloride Reductase (BVC)	NS	--	--	NS	--	--	NS	--	--	ND	U	2.6
	cer A Reductase	NS	--	--	NS	--	--	NS	--	--	ND	U	26.3
	Chloroform Reductase (CFR)	NS	--	--	NS	--	--	NS	--	--	679		26.3
	Dehalobacter DCM (DCM)	NS	--	--	NS	--	--	NS	--	--	5070		26.3
	Dehalobacter spp. (DHBt)	NS	--	--	NS	--	--	NS	--	--	381000		26.3
	Dehalobium chloroeracia (DECO)	NS	--	--	NS	--	--	NS	--	--	11400		26.3
	Dehalococcoides (DHC)	NS	--	--	NS	--	--	NS	--	--	0.9	J	2.6
	Dehalogenimonas spp. (DHG)	NS	--	--	NS	--	--	NS	--	--	1150		26.3
	Desulfitobacterium spp. (DSB)	NS	--	--	NS	--	--	NS	--	--	193000		26.3
	Desulfuromonas spp. (DSM)	NS	--	--	NS	--	--	NS	--	--	3010		26.3
	Dichloromethane Dehalogenase (DCMA)	NS	--	--	NS	--	--	NS	--	--	ND	U	26.3
	Epoxyalkane Transferase (EtnE)	NS	--	--	NS	--	--	NS	--	--	372		26.3
	Ethene Monooxygenase (EtnC)	NS	--	--	NS	--	--	NS	--	--	ND	U	26.3
	Methanogens (MGN)	NS	--	--	NS	--	--	NS	--	--	201000		26.3
	PCE Reductase (PCE-1)	NS	--	--	NS	--	--	NS	--	--	ND	U	26.3
	Phenol Hydroxylase (PHE)	NS	--	--	NS	--	--	NS	--	--	61500		26.3
	PMMO	NS	--	--	NS	--	--	NS	--	--	NA	--	--
	Soluble Methane Monooxygenase (SMMO)	NS	--	--	NS	--	--	NS	--	--	90.1		26.3
	Sulfate Reducing Bacteria (APS)	NS	--	--	NS	--	--	NS	--	--	88600		26.3
	tceA Reductase (TCE)	NS	--	--	NS	--	--	NS	--	--	ND	U	2.6
	Toluene Dioxygenase (TOD)	NS	--	--	NS	--	--	NS	--	--	ND	U	26.3
	Toluene Monooxygenase (RMO)	NS	--	--	NS	--	--	NS	--	--	45600		26.3
	Toluene Monooxygenase 2 (RDEG)	NS	--	--	NS	--	--	NS	--	--	64200		26.3
	Total Eubacteria (EBAC)	NS	--	--	NS	--	--	NS	--	--	23300000		26.3
	trans-1,2-DCE Reductase (TDR)	NS	--	--	NS	--	--	NS	--	--	ND	U	26.3
	Trichlorobenzene Dioxygenase (TCBO)	NS	--	--	NS	--	--	NS	--	--	ND	U	26.3
Vinyl Chloride Reductase (VCR)	NS	--	--	NS	--	--	NS	--	--	ND	U	2.6	
EDB (µg/L) EPA Method 8011	1,2-DIBROMOETHANE	0.57		0.003	1.2		0.0029	0.074		0.00029	0.019	J	0.00029
VFAs (mg/L) EPA Method 300m	ACETIC ACID	45.2		10	9.8	J	10	ND	U	1	ND	U	1
	BUTYRIC ACID	ND	U	1	ND	U	1	ND	U	1	ND	U	1
	FORMIC ACID	0.3	J	1	2.4	J	10	ND	U	1	0.5	J	1
	LACTIC ACID	0.4	J	1	0.4	J	1	0.9	J	1	0.8	J	1
	PROPIONIC ACID	55.5		10	47.6		10	ND	U	1	ND	U	1
	PYRUVIC ACID	ND	U	1	ND	U	1	ND	U	1	ND	U	1
	VALERIC ACID	ND	U	1	ND	U	1	ND	U	1	ND	U	1
Fluorometric (µg/L) Spectrofluorophotometry	FLUORESCEIN	NS	--	--	NS	--	--	NS	--	--	NS	--	--
Reduced Gases (µg/L) RSKSOP-175	ACETYLENE	ND	U	10	ND	U	10	ND	U	10	ND	U	10
	ETHANE	2.1	J	4	1.5	J	4	1.2	J	4	1.6	J	4
	ETHYLENE	9.1		5	6		5	3.6	J	5	2.7	J	5
	METHANE	7211.5		2	9000.4		2	9674		2	11240.9		2
	PROPANE	2.5	J	6	1.8	J	6	ND	U	6	1.8	J	6
General Chemistry (mg/L) SM2320b, EPA Method 300, EPA Method 353.2, SM4500 Pe ^c	ALKALINITY	460		5	430		5	460		5	500		5
	BROMIDE	1		0.5	0.81		0.5	1.5		0.5	1.1		0.5
	CHLORIDE	53		0.5	50		0.5	47		0.5	46		0.5
	IODIDE	4.5		0.75	3.9		0.75	3.6		0.75	4.3		0.75
	NITRATE	NA	--	--	NA	--	--	NA	--	--	NA	--	--
	NITRITE	NA	--	--	NA	--	--	NA	--	--	NA	--	--

Table 15
Analytical Data Table for KAFB-106MW2-S

Phase Designation		Phase 3 Recirculation			Phase 3 Passive								
Sample ID		106MW2S-P3R-082818			106MW2S-P3P-091118			106MW2S-P3P-100218			106MW2S-P3P-111518		
Sample Date		8/28/2018			9/11/2018			10/2/2018			11/15/2018		
Sample Purpose		REG			REG			REG			REG		
Chemical Class and Analytical Method ^a	Parameter	Result	Val Qual	LOQ	Result	Val Qual	LOQ	Result	Val Qual	LOQ	Result	Val Qual	LOQ
General Chemistry (mg/L) SM2320b, EPA Method 300, EPA Method 353.2, SM4500 Pec	NITROGEN, NITRATE-NITRITE	ND	U	0.05	ND	U	0.1	ND	U	0.05	ND	U	0.05
	O-PHOSPHATE (AS P)	NA	--	--	NA	--	--	NA	--	--	NA	--	--
	ORTHOPHOSPHATE	1.1		0.15	1.5		0.15	0.18	J	0.15	ND	UJ	0.15
	PHOSPHORUS	NA	--	--	NA	--	--	NA	--	--	NA	--	--
	SULFATE	ND	U	1	ND	U	1	2.2		1	ND	U	1
Metals (mg/L) EPA Method 6010	LEAD	NS	--	--	NS	--	--	NS	--	--	NS	--	--
Dissolved Metals (mg/L) EPA Method 6010	IRON	8.2		0.05	7.6		0.05	9.2		0.05	10		0.05
	MANGANESE	10		0.003	10		0.003	11		0.003	11		0.003
δ2H (‰) Mass Spectrometry, USGS Reston, VA	DELTA2H	NS	--	--	NS	--	--	NS	--	--	NS	--	--
CSIA EDB δ13C (‰) Kuder et al, 2012	EDB δ	NS	--	--	-4.6 ±8‰	--	--	NS	--	--	NS	--	--
VOCs (µg/L) EPA Method 8260	1,1,2-TRICHLOROETHANE	ND	U	25	ND	U	50	ND	U	50	ND	U	50
	1,2,4-TRICHLOROBENZENE	NA	--	--	NA	--	--	NA	--	--	NA	--	--
	1,2,4-TRIMETHYLBENZENE	220		50	220		100	200		100	190		100
	1,2-DIBROMOETHANE	ND	U	50	ND	U	100	ND	U	100	ND	U	100
	1,2-DICHLOROETHANE	ND	U	50	ND	U	100	ND	U	100	ND	U	100
	1,3,5-TRIMETHYLBENZENE	79		25	76	J	50	78	J	50	75	J	50
	2-BUTANONE	ND	U	500	ND	U	1000	ND	U	1000	ND	U	1000
	2-CHLOROTOLUENE	ND	U	25	ND	U	50	ND	U	50	ND	U	50
	2-HEXANONE	ND	U	250	ND	U	500	ND	U	500	ND	U	500
	4-METHYL-2-PENTANONE	ND	U	250	ND	U	500	ND	U	500	ND	U	500
	ACETONE	ND	U	500	ND	U	1000	ND	U	1000	ND	U	1000
	BENZENE	2800		50	2300		100	1900		100	2100		100
	CARBON DISULFIDE	ND	U	100	ND	U	200	ND	U	200	ND	U	200
	CHLOROMETHANE	ND	U	50	ND	U	100	ND	U	100	ND	U	100
	CIS-1,2-DICHLOROETHENE	NA	--	--	NA	--	--	NA	--	--	NA	--	--
	DICHLORODIFLUOROMETHANE	690		50	640		100	540		100	620		100
	ETHYLBENZENE	73		50	78	J	100	98	J	100	130		100
	ISOPROPYLBENZENE	73		50	78	J	100	98	J	100	130		100
	M,P-XYLENES	NA	--	--	NA	--	--	NA	--	--	NA	--	--
	METHYL TERT-BUTYL ETHER	ND	U	25	ND	U	50	ND	U	50	ND	U	50
	METHYLENE CHLORIDE	150	J	250	ND	U	500	ND	U	500	ND	U	500
	NAPHTHALENE	ND	U	250	ND	U	500	ND	U	500	ND	U	500
	N-BUTYLBENZENE	ND	U	50	ND	U	100	ND	U	100	ND	U	100
	N-PROPYLBENZENE	58		50	57	J	100	55	J	100	56	J	100
	O-XYLENE	NA	--	--	NA	--	--	NA	--	--	NA	--	--
	P-ISOPROPYLTOLUENE	81		50	76	J	100	84	J	100	63	J	100
	SEC-BUTYLBENZENE	ND	U	50	ND	U	100	ND	U	100	ND	U	100
	TERT-BUTYLBENZENE	ND	U	50	ND	U	100	ND	U	100	ND	U	100
	TETRACHLOROETHENE	NA	--	--	NA	--	--	NA	--	--	NA	--	--
	TOLUENE	6600		50	5800		100	5000		100	4900		100
TRANS-1,2-DICHLOROETHENE	NA	--	--	NA	--	--	NA	--	--	NA	--	--	
TRICHLOROETHENE	ND	U	50	ND	U	100	ND	U	100	53	J	100	
TRICHLOROFUOROMETHANE	ND	U	50	ND	U	100	ND	U	100	ND	U	100	
VINYL CHLORIDE	NA	--	--	NA	--	--	NA	--	--	NA	--	--	
XYLENES	2300		25	2000		50	1800		50	2000		50	

Refer to notes at the end of the table.

Table 15
Analytical Data Table for KAFB-106MW2-S

Phase Designation		Phase 4 Passive											
Sample ID		106MW2S-P4P-0111719			106MW2S-LTM-031120			106MW2S-LTM-052020			106MW2S-LTM-080520		
Sample Date		1/17/2019			3/11/2020			5/20/2020			8/5/2020		
Sample Purpose		REG			REG			REG			REG		
Chemical Class and Analytical Method ^a	Parameter	Result	Val Qual	LOQ	Result	Val Qual	LOQ	Result	Val Qual	LOQ	Result	Val Qual	LOQ
Microbial Community (cells/mL) QuantArray-Chlor	1,1 DCA Reductase (DCA)	ND	U	14.3	ND	U	4.8	ND	U	4.9	ND	U	5.1
	1,2 DCA Reductase (DCAR)	ND	U	14.3	ND	U	4.8	ND	U	4.9	ND	U	5.1
	BAV1 Vinyl Chloride Reductase (BVC)	ND	U	1.4	ND	U	0.5	ND	U	0.5	ND	U	0.5
	cer A Reductase	ND	U	14.3	ND	U	4.8	ND	U	4.9	ND	U	5.1
	Chloroform Reductase (CFR)	ND	U	14.3	ND	U	4.8	ND	U	4.9	ND	U	5.1
	Dehalobacter DCM (DCM)	ND	U	14.3	524		4.8	1670		4.9	ND	U	5.1
	Dehalobacter spp. (DHBt)	155000		14.3	45300		4.8	119000		4.9	147000		5.1
	Dehalobium chloro-coercia (DECO)	12800		14.3	3190		4.8	6330		4.9	14600		5.1
	Dehalococcoides (DHC)	1.6		1.4	2.4		0.5	2.5		0.5	2.6		0.5
	Dehalogenimonas spp. (DHG)	1190		14.3	762		4.8	777		4.9	ND	U	5.1
	Desulfitobacterium spp. (DSB)	60600		14.3	14000		4.8	26300		4.9	21100		5.1
	Desulfuromonas spp. (DSM)	433		14.3	35.2		4.8	2810		4.9	270		5.1
	Dichloromethane Dehalogenase (DCMA)	ND	U	14.3	ND	U	4.8	ND	U	4.9	ND	U	5.1
	Epoxyalkane Transferase (EtnE)	ND	U	14.3	ND	U	4.8	31.9		4.9	186		5.1
	Ethene Monooxygenase (EtnC)	ND	U	14.3	ND	U	4.8	ND	U	4.9	ND	U	5.1
	Methanogens (MGN)	583000		14.3	61800		4.8	23100		4.9	26600		5.1
	PCE Reductase (PCE-1)	ND	U	14.3	ND	U	4.8	ND	U	4.9	ND	U	5.1
	Phenol Hydroxylase (PHE)	8080		14.3	2100		4.8	18800		4.9	25200		5.1
	PMMO	NA	--	--	NA	--	--	NA	--	--	NA	--	--
	Soluble Methane Monooxygenase (SMMO)	213		14.3	45.7		4.8	404		4.9	2440		5.1
	Sulfate Reducing Bacteria (APS)	28200		14.3	14700		4.8	79200		4.9	131000		5.1
	tceA Reductase (TCE)	ND	U	1.4	ND	U	0.5	ND	U	0.5	ND	U	0.5
	Toluene Dioxygenase (TOD)	ND	U	14.3	ND	U	4.8	ND	U	4.9	ND	U	5.1
	Toluene Monooxygenase (RMO)	20800		14.3	21800		4.8	56500		4.9	243000		5.1
	Toluene Monooxygenase 2 (RDEG)	15800		14.3	3710		4.8	17100		4.9	9630		5.1
	Total Eubacteria (EBAC)	14500000		14.3	5430000		4.8	12800000		4.9	27200000		5.1
	trans-1,2-DCE Reductase (TDR)	ND	U	14.3	ND	U	4.8	ND	U	4.9	ND	U	5.1
Trichlorobenzene Dioxygenase (TCBO)	ND	U	14.3	98.9		4.8	136		4.9	ND	U	5.1	
Vinyl Chloride Reductase (VCR)	0.3	J	1.4	0.2	J	0.5	ND	U	0.5	ND	U	0.5	
EDB (µg/L) EPA Method 8011	1,2-DIBROMOETHANE	0.016	J	0.00029	ND	U	0.011	0.13		0.01	0.024	J	0.011
VFAs (mg/L) EPA Method 300m	ACETIC ACID				ND	U	1	ND	U	10	ND	U	10
	BUTYRIC ACID				ND	U	1	ND	U	10	ND	U	10
	FORMIC ACID				0.5	J	10	ND	U	10	2.6	J	10
	LACTIC ACID	1		1	1.1	J	10	ND	U	10	ND	U	10
	PROPIONIC ACID	ND	U	1	ND	U	1	ND	U	10	ND	U	10
	PYRUVIC ACID	ND	U	1	ND	U	1	ND	U	10	ND	U	10
	VALERIC ACID	ND	U	1	ND	U	1	ND	U	10	ND	U	10
Fluorometric (µg/L) Spectrofluorophotometry	FLUORESCEIN	NS	--	--	NS	--	--	NS	--	--	NS	--	--
Reduced Gases (µg/L) RSKSOP-175	ACETYLENE	ND	U	10	ND	U	10	ND	U	10	ND	U	10
	ETHANE	2	J	4	0.9	J	4	4.3		4	2.6	J	4
	ETHYLENE	2.4	J	5	ND	U	5	1.9	J	5	1.7	J	5
	METHANE	11940.9		20	3147.7		2	9877.3		2	7487.4		2
	PROPANE	2	J	6	ND	U	6	3	J	6	2	J	6
General Chemistry (mg/L) SM2320b, EPA Method 300, EPA Method 353.2, SM4500 Pe ^c	ALKALINITY	520		5	568		5	533		5	506		5
	BROMIDE	0.67		0.5	0.838		0.1	0.762		0.1	1.25		0.1
	CHLORIDE	46		0.5	47.9		0.5	46.8		0.5	49.9		0.5
	IODIDE	3.9	J+	1.5	4.3		0.2	5		0.2	5.6		2
	NITRATE	NA	--	--	0.056	J	0.1	0.0627	J	0.1	ND	U	0.1
	NITRITE	NA	--	--	NA	--	--	NA	--	--	NA	--	--

Table 15
Analytical Data Table for KAFB-106MW2-S

Phase Designation		Phase 4 Passive											
Sample ID		106MW2S-P4P-0111719			106MW2S-LTM-031120			106MW2S-LTM-052020			106MW2S-LTM-080520		
Sample Date		1/17/2019			3/11/2020			5/20/2020			8/5/2020		
Sample Purpose		REG			REG			REG			REG		
Chemical Class and Analytical Method ^a	Parameter	Result	Val Qual	LOQ	Result	Val Qual	LOQ	Result	Val Qual	LOQ	Result	Val Qual	LOQ
General Chemistry (mg/L) SM2320b, EPA Method 300, EPA Method 353.2, SM4500 Pec	NITROGEN, NITRATE-NITRITE	ND	UJ	0.05	ND	U	0.1	ND	U	0.1	ND	U	0.1
	O-PHOSPHATE (AS P)	NA	--	--	NA	--	--	NA	--	--	NA	--	--
	ORTHOPHOSPHATE	ND	UJ	0.15	NA	--	--	NA	--	--	NA	--	--
	PHOSPHORUS	NA	--	--	0.022	J	0.025	ND	U	0.025	ND	U	0.025
	SULFATE	ND	U	1	ND	U	0.5	0.414	J	0.5	0.546		0.5
Metals (mg/L) EPA Method 6010	LEAD	NS	--	--	ND	U	0.001	ND	U	0.001	ND	U	0.001
Dissolved Metals (mg/L) EPA Method 6010	IRON	13		0.05	15.2		0.05	15.2		0.05	14.4		0.05
	MANGANESE	11		0.003	8.65		0.125	8.45		0.25	8.26		0.125
δ ² H (‰) Mass Spectrometry, USGS Reston, VA	DELTA2H	NS	--	--	NS	--	--	NS	--	--	NS	--	--
CSIA EDB δ ¹³ C (‰) Kuder et al, 2012	EDB δ	NS	--	--	NS	--	--	NS	--	--	NS	--	--
VOCs (µg/L) EPA Method 8260	1,1,2-TRICHLOROETHANE	ND	U	25	ND	U	2.5	ND	U	5	ND	U	1
	1,2,4-TRICHLOROBENZENE	NA	--	--	ND	U	2.5	ND	U	5	ND	U	1
	1,2,4-TRIMETHYLBENZENE	240		50	NA	--	--	NA	--	--	NA	--	--
	1,2-DIBROMOETHANE	ND	U	50	ND	U	2.5	ND	U	2.5	ND	U	0.5
	1,2-DICHLOROETHANE	NA	--	--	ND	U	2.5	ND	U	2.5	ND	U	0.5
	1,3,5-TRIMETHYLBENZENE	92		25	100		2.5	100		5	83		1
	2-BUTANONE	ND	U	500	ND	U	5	ND	U	5	3.1		1
	2-CHLOROTOLUENE	ND	U	25	ND	U	2.5	ND	U	5	ND	U	1
	2-HEXANONE	ND	U	250	ND	U	5	ND	U	10	ND	U	2
	4-METHYL-2-PENTANONE	ND	U	250	ND	U	5	ND	U	10	ND	U	2
	ACETONE	ND	U	500	ND	U	5	ND	U	5	19		1
	BENZENE	2400		50	2700		25	2200		12	1500		12
	CARBON DISULFIDE	ND	U	100	ND	U	5	ND	U	5	ND	U	1
	CHLOROMETHANE	ND	U	50	ND	U	2.5	ND	U	2.5	ND	U	0.5
	CIS-1,2-DICHLOROETHENE	NA	--	--	ND	U	2.5	ND	U	2.5	ND	U	0.5
	DICHLORODIFLUOROMETHANE	NA	--	--	ND	U	2.5	ND	U	5	ND	U	1
	ETHYLBENZENE	190		50	970		2.5	880		5	590		25
	ISOPROPYLBENZENE	190		50	170		2.5	160		5	120		1
	M,P-XYLENES	NA	--	--	2000		5	1800		5	1300		25
	METHYL TERT-BUTYL ETHER	ND	U	25	ND	U	2.5	ND	U	2.5	ND	U	0.5
	METHYLENE CHLORIDE	ND	U	250	ND	U	5	10		5	ND	U	1
	NAPHTHALENE	ND	U	250	94		2.5	110		5	94		1
	N-BUTYLBENZENE	ND	U	50	11		2.5	12		5	13		1
	N-PROPYLBENZENE	65		50	88		2.5	85		5	72		1
	O-XYLENE	NA	--	--	950		2.5	870		5	670		25
	P-ISOPROPYLTOLUENE	80		50	58		2.5	60		5	76		1
	SEC-BUTYLBENZENE	ND	U	50	14		2.5	14		5	17		1
	TERT-BUTYLBENZENE	ND	U	50	ND	U	2.5	ND	U	5	ND	U	1
	TETRACHLOROETHENE	NA	--	--	ND	U	2.5	ND	U	5	ND	U	1
	TOLUENE	150		50	11		2.5	7.5		2.5	ND	U	0.5
TRANS-1,2-DICHLOROETHENE	NA	--	--	ND	U	2.5	ND	U	2.5	ND	U	0.5	
TRICHLOROETHENE	ND	U	50	ND	U	2.5	ND	U	2.5	ND	U	0.5	
TRICHLOROFUOROMETHANE	ND	U	50	ND	U	2.5	ND	U	5	ND	U	1	
VINYL CHLORIDE	NA	--	--	ND	U	2.5	ND	U	2.5	ND	U	0.5	
XYLENES	2600		25	2900		2.5	2700		5	2000		25	

Refer to notes at the end of the table.

Table 15
Analytical Data Table for KAFB-106MW2-S

Phase Designation		Phase 4 Passive		
Sample ID		106MW2S-LTM-101420		
Sample Date		10/14/2020		
Sample Purpose		REG		
Chemical Class and Analytical Method ^a	Parameter	Result	Val Qual	LOQ
Microbial Community (cells/mL) QuantArray-Chlor	1,1 DCA Reductase (DCA)	5.2		5.2
	1,2 DCA Reductase (DCAR)	5.2		5.2
	BAV1 Vinyl Chloride Reductase (BVC)	0.5		0.5
	cer A Reductase	5.2		5.2
	Chloroform Reductase (CFR)	5.2		5.2
	Dehalobacter DCM (DCM)	1740		5.2
	Dehalobacter spp. (DHBt)	83200		5.2
	Dehalobium chloroeracia (DECO)	7370		5.2
	Dehalococcoides (DHC)	4.2		0.5
	Dehalogenimonas spp. (DHG)	5890		5.2
	Desulfitobacterium spp. (DSB)	20900		5.2
	Desulfuromonas spp. (DSM)	212		5.2
	Dichloromethane Dehalogenase (DCMA)	5.2		5.2
	Epoxyalkane Transferase (EtnE)	116		5.2
	Ethene Monooxygenase (EtnC)	5.2		5.2
	Methanogens (MGN)	40600		5.2
	PCE Reductase (PCE-1)	5.2		5.2
	Phenol Hydroxylase (PHE)	9520		5.2
	PMMO	NA	--	--
	Soluble Methane Monooxygenase (SMMO)	1100		5.2
	Sulfate Reducing Bacteria (APS)	96600		5.2
	tceA Reductase (TCE)	0.5		0.5
	Toluene Dioxygenase (TOD)	5.2		5.2
	Toluene Monooxygenase (RMO)	60800		5.2
	Toluene Monooxygenase 2 (RDEG)	9540		5.2
	Total Eubacteria (EBAC)	25200000		5.2
	trans-1,2-DCE Reductase (TDR)	5.2		5.2
Trichlorobenzene Dioxygenase (TCBO)	5.2		5.2	
Vinyl Chloride Reductase (VCR)	0.5		0.5	
EDB (µg/L) EPA Method 8011	1,2-DIBROMOETHANE	0.087		0.01
VFAs (mg/L) EPA Method 300m	ACETIC ACID	ND	U	10
	BUTYRIC ACID	ND	U	10
	FORMIC ACID	1.9	J	10
	LACTIC ACID	0.6	J	10
	PROPIONIC ACID	ND	U	10
	PYRUVIC ACID	ND	U	10
	VALERIC ACID	ND	U	10
Fluorometric (µg/L) Spectrofluorophotometry	FLUORESCEIN	NS	--	--
Reduced Gases (µg/L) RSKSOP-175	ACETYLENE	ND	U	10
	ETHANE	1.3		4
	ETHYLENE	0.9		5
	METHANE	3155.1		2
	PROPANE	0.9		6
General Chemistry (mg/L) SM2320b, EPA Method 300, EPA Method 353.2, SM4500 Pe ^c	ALKALINITY	490		5
	BROMIDE	1.74		0.1
	CHLORIDE	49.3		0.5
	IODIDE	6.3		
	NITRATE	0.884		0.1
	NITRITE	NA	--	--

Table 15
Analytical Data Table for KAFB-106MW2-S

Phase Designation		Phase 4 Passive		
Sample ID		106MW2S-LTM-101420		
Sample Date		10/14/2020		
Sample Purpose		REG		
Chemical Class and Analytical Method ^a	Parameter	Result	Val Qual	LOQ
General Chemistry (mg/L) SM2320b, EPA Method 300, EPA Method 353.2, SM4500 Pec	NITROGEN, NITRATE-NITRITE	ND	U	0.1
	O-PHOSPHATE (AS P)	NA	--	--
	ORTHOPHOSPHATE	NA	--	--
	PHOSPHORUS	ND	U	0.025
	SULFATE	0.841		0.5
Metals (mg/L) EPA Method 6010	LEAD	ND	U	0.001
Dissolved Metals (mg/L) EPA Method 6010	IRON	11.3		0.05
	MANGANESE	6.72		0.125
δ2H (‰) Mass Spectrometry, USGS Reston, VA	DELTA2H	NS	--	--
CSIA EDB δ13C (‰) Kuder et al, 2012	EDB δ	NS	--	--
VOCs (µg/L) EPA Method 8260	1,1,2-TRICHLOROETHANE	ND	U	5
	1,2,4-TRICHLOROBENZENE	ND	U	5
	1,2,4-TRIMETHYLBENZENE	NA	--	--
	1,2-DIBROMOETHANE	ND	U	2.5
	1,2-DICHLOROETHANE	ND	U	2.5
	1,3,5-TRIMETHYLBENZENE	73		5
	2-BUTANONE	ND	U	5
	2-CHLOROTOLUENE	ND	U	2.5
	2-HEXANONE	ND	U	10
	4-METHYL-2-PENTANONE	ND	U	10
	ACETONE	ND	U	5
	BENZENE	1700		25
	CARBON DISULFIDE	ND	U	10
	CHLOROMETHANE	ND	U	2.5
	CIS-1,2-DICHLOROETHENE	ND	U	2.5
	DICHLORODIFLUOROMETHANE	ND	U	2.5
	ETHYLBENZENE	630		5
	ISOPROPYLBENZENE	110		2.5
	M,P-XYLENES	1400		5
	METHYL TERT-BUTYL ETHER	ND	U	2.5
	METHYLENE CHLORIDE	ND	U	5
	NAPHTHALENE	79		2.5
	N-BUTYLBENZENE	27		5
	N-PROPYLBENZENE	67		5
	O-XYLENE	700		5
	P-ISOPROPYLTOLUENE	75		5
	SEC-BUTYLBENZENE	15		2.5
	TERT-BUTYLBENZENE	ND	U	5
	TETRACHLOROETHENE	ND	U	2.5
	TOLUENE	5.1		2.5
	TRANS-1,2-DICHLOROETHENE	ND	U	2.5
	TRICHLOROETHENE	ND	U	2.5
	TRICHLOROFLUOROMETHANE	ND	U	2.5
VINYL CHLORIDE	ND	U	2.5	
XYLENES	2100		2.5	

Refer to notes at the end of the table.

Table 15
Analytical Data Table for KAFB-106MW2-S

Notes:

Sampling frequency for each analytical method is outlined in Table 4.

a. EPA analytical methods listed are for the most recent sampling event.

b. Samples were collected using replacement QED Bladder Pumps. This well was not sampled using the Geotech pumps.

-- = Not applicable.

δ2H - Delta Deuterium.

0/00 - Per mil.

cells/mL = Cells per milliliter.

EPA = Environmental Protection Agency.

FD = Field duplicate.

ID = Identification.

J = Estimated value, concentration is less than LOQ but greater than laboratory method detection limit (DL).

J+ = Estimated value, concentration is less than LOQ but greater than laboratory method detection limit (DL); biased high.

J- = Estimated value, concentration is less than LOQ but greater than laboratory method detection limit (DL); biased low.

KAFB = Kirtland Air Force Base.

LOQ = Limit of Quantitation

µg/L = Microgram per liter.

mg/L = Milligram per liter.

NA = Not analyzed.

ND = Not detected.

NS = Not sampled.

REG = Regular/parent sample.

U = Analyte was not detected. The reported numerical value is at or below the LOQ.

UJ = Analyte was not detected. The reported value is estimated.

VAL QUAL = Validation qualifier.

VFA - Volatile fatty acid.

VOC = Volatile organic compound.

Table 16
Measures of Tracer Distribution during Phase 1

Well ID	Distance from Injection Well at Surface (Feet)	Greatest Fluorescein Concentration (µg/L)	Greatest δ²H Value (‰)	Date of Greatest Tracer Contribution (fluorescein and δ²H)	Transport Time (as indicated by date of greatest tracer contribution [days])
KAFB-106IN1	--	570 ^a	+590 ^a	10/2/2017	--
KAFB-106MW2-S	28	207.7	+128	10/6/2017	3.5
KAFB-106064	31	144.5	+124	10/6/2017	3.5
KAFB-106MW1-S	47	64.9	-31	10/12/2017	9.5
KAFB-106EX2	76	10.1	-83	10/26/2017 (fluorescein) 11/1/2017 (δ ² H) ^b	22.5-29.5 ^b
KAFB-106EX1	92	3.7	-90	11/1/2017 ^b	29.5 ^b

Notes:

^a Average injected concentration over 24-hour period.

^b Greatest quantities occurred at the last sampling of recirculation period and it is unknown if greater quantities might have been observed later had recirculation continued

‰ - Per mil.

δ²H - delta deuterium (measure of hydrogen isotope composition).

ID - Identification.

KAFB - Kirtland Air Force Base.

µg/L - Micrograms per liter.

**Table 17
Contaminant Reduction during Test Phases**

Well ID	n - Log ₁₀ Concentration Reduction During Passive Phase Relative to Recirculation											
	Phase 1			Phase 2			Phase 3			Phase 4 ^a		
	Benzene	Toluene	EDB	Benzene	Toluene	EDB	Benzene	Toluene	EDB	Benzene	Toluene	EDB
KAFB-106064	-0.1	-0.4	0.6	0.0	-0.1	1.1	0.1	0.0	2.5	0.1	1.2	4.2
KAFB-106MW1-S	0.0	-0.1	0.3	-0.1	-0.1	0.9	-0.4	-0.3	0.3	0.5	1.1	4.6
KAFB-106MW2-S	0.0	0.1	0.7	0.2	0.2	3.6	0.2	0.2	2.7	-0.5	2.5	3.0
KAFB-106EX1	0.1	0.1	0.6	0.0	0.0	1.5	0.1	0.0	1.4	-0.1	2.7	3.5
KAFB-106EX2	0.0	0.0	0.1	0.0	0.1	0.0	0.1	0.1	0.3	-0.3	0.0	2.6
KAFB-106IN1	0.0	0.0	0.6	0.1	0.2	3.6	0.7	0.5	3.0	0.3	2.7	3.3
KAFB-106063	^{-b}	^{-b}	^{-b}	0.0	-0.8	0.2	-0.2	-0.4	0.5	0.2	1.0	2.8
KAFB-106MW1-I	2.8	2.4	1.3	1.1	1.7	1.0	0.0	0.6	0.6	1.7	3.7	3.7
KAFB-106MW2-I	0.7	1.7	0.6	1.8	2.5	1.1	0.7	0.9	0.5	3.7	3.9	3.9
Percent Reduction												
KAFB-106064	-17.20%	-158.62%	73.29%	6.14%	-14.60%	92.13%	20.00%	8.33%	99.69%	23.89%	94.27%	99.99%
KAFB-106MW1-S	-4.68%	-18.97%	54.04%	-18.70%	-20.75%	88.27%	-164.86%	-81.82%	52.73%	64.81%	92.62%	100.00%
KAFB-106MW2-S	-5.13%	11.18%	77.94%	30.89%	32.51%	99.98%	41.67%	38.75%	99.78%	-190.10%	99.67%	99.90%
KAFB-106EX1	25.58%	17.15%	75.19%	-10.38%	-5.76%	96.58%	21.05%	10.20%	95.61%	-19.62%	99.79%	99.97%
KAFB-106EX2	-8.61%	-0.73%	13.87%	-2.35%	15.74%	-11.11%	25.00%	27.84%	47.42%	-104.89%	6.06%	99.75%
KAFB-106IN1	3.65%	9.37%	74.81%	21.69%	32.19%	99.98%	78.50%	66.21%	99.89%	48.19%	99.81%	99.95%
KAFB-106063	^{-b}	^{-b}	^{-b}	6.96%	-501.90%	38.01%	-70.49%	-181.48%	71.20%	39.06%	90.53%	99.84%
KAFB-106MW1-I	99.83%	99.60%	95.19%	91.85%	97.82%	90.93%	8.33%	73.75%	72.50%	98.19%	99.98%	99.98%
KAFB-106MW2-I	82.10%	98.11%	74.02%	98.39%	99.68%	92.81%	80.00%	86.67%	66.88%	99.98%	99.99%	99.99%

Notes:

^a Reduction Relative to Baseline Before Pilot Test for shallow wells, and to maximum concentration for intermediate wells.

^b No previous quantity for comparison.

% - Percent.

EDB - ethylene dibromide.

ID - Identification.

KAFB - Kirtland Air Force Base.